



CY8CKIT-147

PSoC[®] 4100PS Prototyping Kit Guide

Doc. #: 002-18734 Rev. *D

Cypress Semiconductor
198 Champion Court
San Jose, CA 95134-1709
www.cypress.com

Copyrights

© Cypress Semiconductor Corporation, 2017-2018. This document is the property of Cypress Semiconductor Corporation and its subsidiaries, including Spansion LLC ("Cypress"). This document, including any software or firmware included or referenced in this document ("Software"), is owned by Cypress under the intellectual property laws and treaties of the United States and other countries worldwide. Cypress reserves all rights under such laws and treaties and does not, except as specifically stated in this paragraph, grant any license under its patents, copyrights, trademarks, or other intellectual property rights. If the Software is not accompanied by a license agreement and you do not otherwise have a written agreement with Cypress governing the use of the Software, then Cypress hereby grants you a personal, non-exclusive, nontransferable license (without the right to sublicense) (1) under its copyright rights in the Software (a) for Software provided in source code form, to modify and reproduce the Software solely for use with Cypress hardware products, only internally within your organization, and (b) to distribute the Software in binary code form externally to end users (either directly or indirectly through resellers and distributors), solely for use on Cypress hardware product units, and (2) under those claims of Cypress's patents that are infringed by the Software (as provided by Cypress, unmodified) to make, use, distribute, and import the Software solely for use with Cypress hardware products. Any other use, reproduction, modification, translation, or compilation of the Software is prohibited.

TO THE EXTENT PERMITTED BY APPLICABLE LAW, CYPRESS MAKES NO WARRANTY OF ANY KIND, EXPRESS OR IMPLIED, WITH REGARD TO THIS DOCUMENT OR ANY SOFTWARE OR ACCOMPANYING HARDWARE, INCLUDING, BUT NOT LIMITED TO, THE IMPLIED WARRANTIES OF MERCHANTABILITY AND FITNESS FOR A PARTICULAR PURPOSE. No computing device can be absolutely secure. Therefore, despite security measures implemented in Cypress hardware or software products, Cypress does not assume any liability arising out of any security breach, such as unauthorized access to or use of a Cypress product. In addition, the products described in these materials may contain design defects or errors known as errata which may cause the product to deviate from published specifications. To the extent permitted by applicable law, Cypress reserves the right to make changes to this document without further notice. Cypress does not assume any liability arising out of the application or use of any product or circuit described in this document. Any information provided in this document, including any sample design information or programming code, is provided only for reference purposes. It is the responsibility of the user of this document to properly design, program, and test the functionality and safety of any application made of this information and any resulting product. Cypress products are not designed, intended, or authorized for use as critical components in systems designed or intended for the operation of weapons, weapons systems, nuclear installations, life-support devices or systems, other medical devices or systems (including resuscitation equipment and surgical implants), pollution control or hazardous substances management, or other uses where the failure of the device or system could cause personal injury, death, or property damage ("Unintended Uses"). A critical component is any component of a device or system whose failure to perform can be reasonably expected to cause the failure of the device or system, or to affect its safety or effectiveness. Cypress is not liable, in whole or in part, and you shall and hereby do release Cypress from any claim, damage, or other liability arising from or related to all Unintended Uses of Cypress products. You shall indemnify and hold Cypress harmless from and against all claims, costs, damages, and other liabilities, including claims for personal injury or death, arising from or related to any Unintended Uses of Cypress products.

Cypress, the Cypress logo, Spansion, the Spansion logo, and combinations thereof, WICED, PSoC, CapSense, EZ-USB, F-RAM, and Traveo are trademarks or registered trademarks of Cypress in the United States and other countries. For a more complete list of Cypress trademarks, visit cypress.com. Other names and brands may be claimed as property of their respective owners.

Contents



Safety Information	5
1. Introduction	7
1.1 Kit Contents	7
1.2 PSoC Creator	8
1.2.1 PSoC Creator Code Examples	9
1.2.2 Kit Code Examples.....	10
1.2.3 PSoC Creator Help	10
1.2.4 Component Datasheets	11
1.3 Getting Started.....	11
1.4 Additional Learning Resources	12
1.5 Technical Support.....	12
1.6 Document Conventions	13
1.7 Acronyms	14
2. Software Installation	15
2.1 Before You Begin.....	15
2.2 Install Software	15
2.3 Installing PSoC 4100PS Device in PSoC Creator	18
2.4 Uninstall Software	18
3. Kit Operation	19
3.1 Theory of Operation.....	19
3.2 Programming and Debugging the PSoC 4100PS Target Device	21
3.2.1 Programming Using PSoC Creator	21
3.2.2 Debugging Using PSoC Creator	23
3.2.3 Programming Using PSoC Programmer	23
3.2.4 Mass Storage Programming.....	23
3.3 USB-UART Bridge	23
3.4 USB-I2C Bridge	24
3.5 Updating the KitProg2 Firmware.....	24
4. Code Examples	25
4.1 Using the Kit Code Examples	25
4.2 Using Built-in PSoC Creator Code Examples with the Kit	28

Appendix	30
Board Details	30
Hardware Details	32
Target Board	32
KitProg2 Board	33
Power Supply System	34
Board Separation (Snapping)	34
Header Connections	35
User and Passive Inputs	39
PSoC 4100PS Prototyping kit Schematics	42
Bill of Materials	42
Programming PSoC 4100PS Prototyping kit Using MiniProg3/KitProg2	42
Revision History	43

Safety Information



Regulatory Compliance

The CY8CKIT-147 PSoC 4100PS Prototyping Kit is intended for use as a development platform for hardware or software in a laboratory environment. The board is an open system design, which does not include a shielded enclosure. This may cause interference to other electrical or electronic devices in close proximity. In a domestic environment, this product may cause radio interference. In such cases, you may be required to take adequate preventive measures. In addition, this board should not be used near any medical equipment or RF devices.

Attaching additional wiring to this product or modifying the product operation from the factory default settings may affect its performance and cause interference with other apparatus in the immediate vicinity. If such interference is detected, suitable mitigating measures should be taken.



The PSoC 4100PS Prototyping Kit, as shipped from the factory, has been verified to meet with requirements of CE as a Class A product.



The PSoC 4100PS Prototyping Kit contains electrostatic discharge (ESD) sensitive devices. Electrostatic charges readily accumulate on the human body and any equipment, and can discharge without detection. Permanent damage may occur on devices subjected to high-energy discharges. Proper ESD precautions are recommended to avoid performance degradation or loss of functionality. Store unused PSoC 4100PS Prototyping Kit boards in the protective shipping package.



End-of-Life/Product Recycling

This kit has an end-of life five years from the date of manufacture mentioned on the back of the box. Contact your nearest recycler for discarding the kit.

General Safety Instructions

ESD Protection

ESD can damage boards and associated components. Cypress recommends that you perform procedures only at an ESD workstation. If such a workstation is not available, use appropriate ESD protection by wearing an antistatic wrist strap attached to the chassis ground (any unpainted metal surface) on your board when handling parts.

Handling Boards

PSoC 4100PS Prototyping boards are sensitive to ESD. Hold the board only by its edges. After removing the board from its box, place it on a grounded, static-free surface. Use a conductive foam pad if available. Do not slide board over any surface.

1. Introduction



Thank you for your interest in the CY8CKIT-147 PSoC 4100PS Prototyping Kit. The PSoC 4100PS prototyping kit is designed as an easy-to-use and inexpensive prototyping platform. The PSoC 4100PS Prototyping Kit supports the PSoC 4100PS device family, delivering a complete system solution for a wide range of embedded applications at a very low cost. The PSoC 4100PS device is a true programmable embedded system-on chip, integrating custom digital peripheral functions, memory, and an ARM® Cortex®-M0+ microcontroller on a single chip. The programmable digital peripheral functions allow higher flexibility, in-field tuning of the design, and faster time-to-market.

The PSoC 4100PS Prototyping Kit offers an open footprint breakout board to maximize the end-utility of the PSoC 4100PS device. This kit provides a low-cost alternative to device samples while providing a platform to easily develop and integrate the PSoC 4100PS device into your end-system. In addition, the board includes the following features:

- An LED to provide feedback
- A push button to provide a simple user input
- 1.8 V to 5 V operation

The PSoC 4100PS prototyping kit also integrates the Cypress KitProg2 that enables on-board programming, debugging and bridging functionality, such as USB-UART and USB-I2C. The KitProg2 is used to program and debug the target PSoC 4100PS device (see [Figure 1-1](#)). The prototyping kit allows you to separate the KitProg2 board from the PSoC 4100PS target board.

1.1 Kit Contents

The PSoC 4100PS Prototyping Kit contains a PSoC 4100PS Prototyping board and Quick Start Guide.

Figure 1-1. CY8CKIT-147 PSoC 4100PS Prototyping Kit

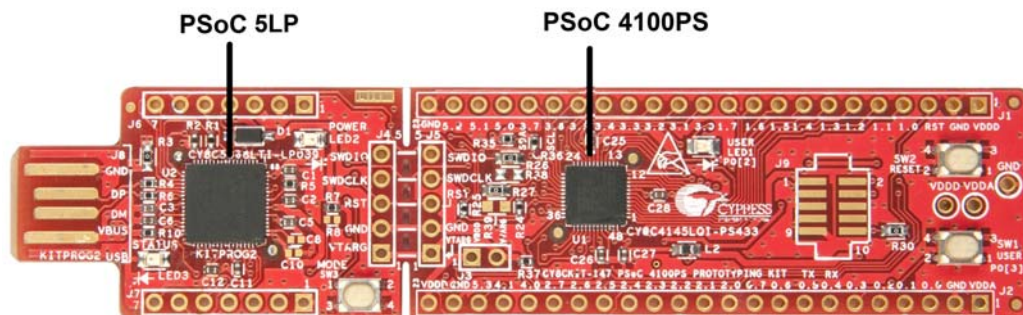

1.2 PSoC Creator

PSoC Creator™ is a state-of-the-art, easy-to-use integrated design environment (IDE). It introduces revolutionary hardware and software co-design, powered by a library of pre-verified and pre-characterized PSoC Components. With PSoC Creator, you can:

1. Drag and drop Components to build your hardware system design in the main design workspace
2. Co-design your application firmware with the PSoC hardware
3. Configure Components using configuration tools
4. Explore the library of 100+ Components
5. Review Component datasheets

Figure 1-2. PSoC Creator Features

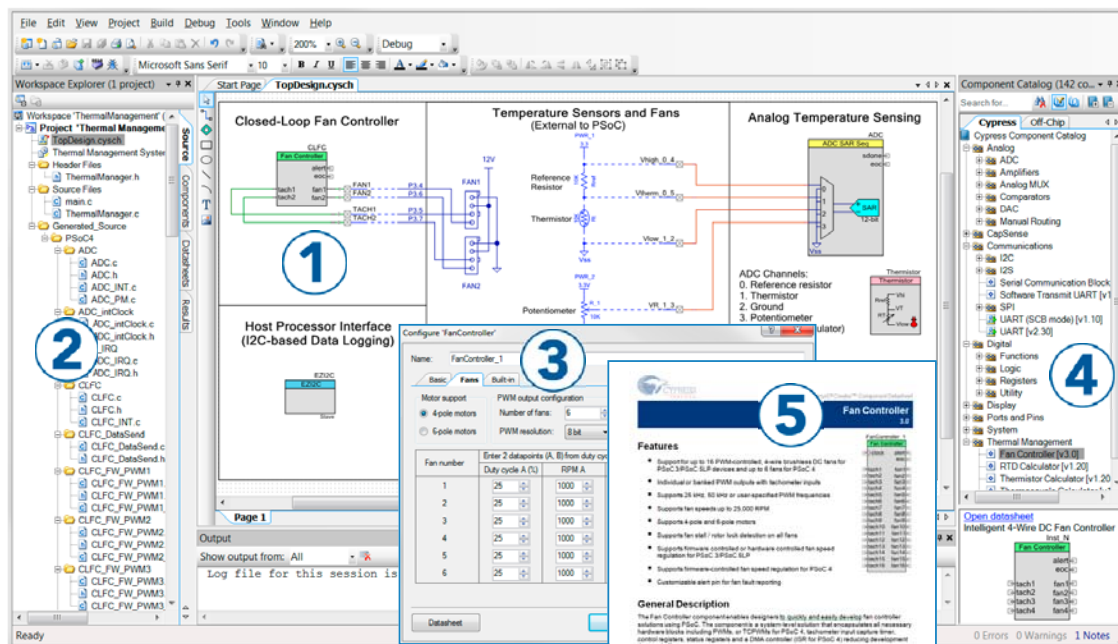

PSoC Creator also enables you to tap into an entire tool ecosystem with integrated compiler chains and production programming programmers for PSoC devices.

For more information, visit www.cypress.com/psoccreator. Visit the [PSoC Creator Video Training Page](#) for video tutorials on learning and using PSoC Creator.

1.2.1 PSoC Creator Code Examples

PSoC Creator includes a large number of code examples. These examples are available from the PSoC Creator Start Page, as [Figure 1-3 on page 9](#) shows or from the menu under “**File > Code Example...**”.

Code examples can speed up your design process by starting you off with a complete design, instead of a blank page. The code examples also show how PSoC Creator Components can be used for various applications. Code examples and documentation are included, as shown in [Figure 1-4 on page 10](#).

In the **Find Code Example** dialog shown in [Figure 1-4](#), you have several options:

- Filter for examples based on architecture or device family, that is, PSoC 3, PSoC 4, or PSoC 5LP; project name; or keyword
- Select from the list of examples offered based on the **Filter Options**
- Review the code example’s description (on the **Documentation** tab)
- Review the code from the **Sample Code** tab. You can copy the code from this window and paste to your project, which can help speed up code development
- Create a new project (and a new workspace if needed) based on the selection. This can speed up your design process by starting you off with a complete, basic design. You can then adapt that design to your application.

Figure 1-3. Code Examples in PSoC Creator

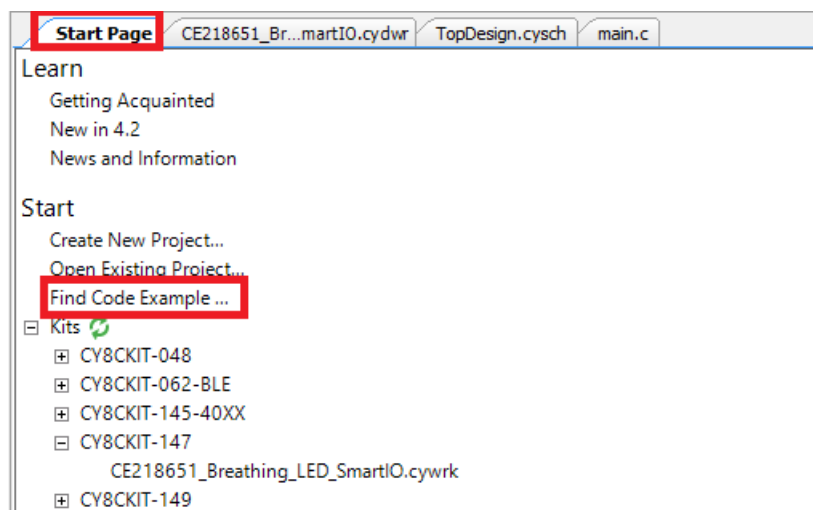
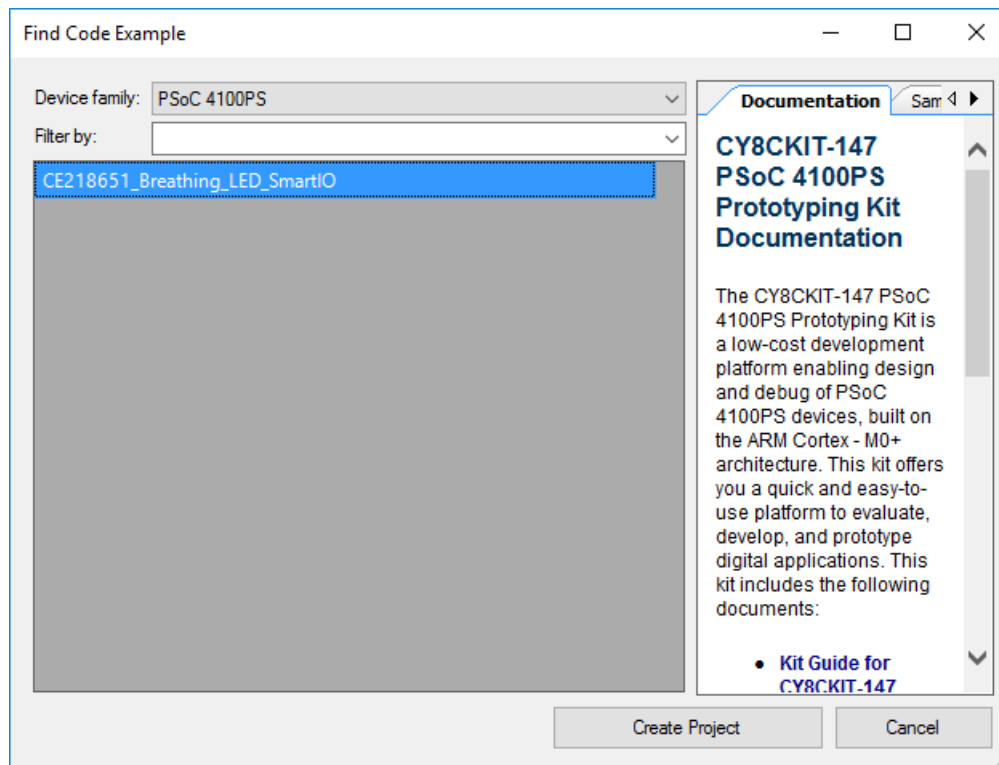

Figure 1-4. Code Example Projects with Sample Code



1.2.2 Kit Code Examples

You can access the installed kit code examples from the PSoC Creator Start Page. To access these examples, expand the **Kits** under the section **Start**; then, expand the specific kit to see the code examples. Refer to the [Code Examples chapter on page 25](#) for a list of code examples that you can use on this kit.

1.2.3 PSoC Creator Help

Launch PSoC Creator and navigate to the following items:

- **Quick Start Guide:** Choose **Help > Documentation > Quick Start Guide**. This guide gives you the basics for developing PSoC Creator projects.
- **Simple Component Code Examples:** Choose **File > Code Example**. These examples demonstrate how to configure and use PSoC Creator Components. To access examples related to a specific Component, right-click on the Component in the schematic or in the Component Catalog. Select the **Find Code Example** option in the context menu that appears.
- **System Reference Guide:** Choose **Help > System Reference Guides**. This guide lists and describes the system functions provided by PSoC Creator.

1.2.4 Component Datasheets

Right-click a Component and select **Open Datasheet** (see [Figure 1-5 on page 11](#)).

Figure 1-5. Opening Component Datasheet

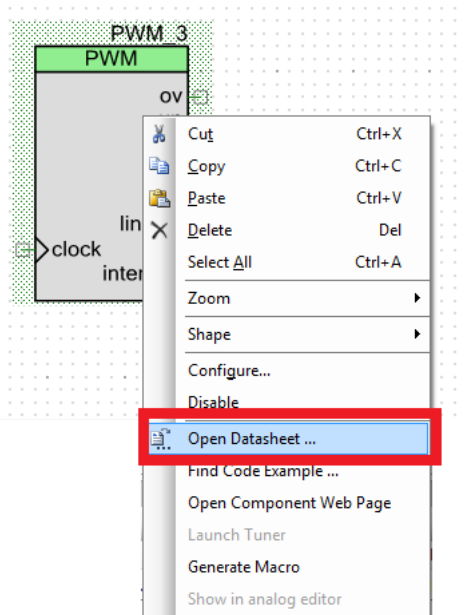

1.3 Getting Started

This guide will help you get acquainted with the PSoC 4100PS Prototyping Kit:

- The [Software Installation chapter on page 15](#) describes the installation of the kit software. This includes installation of the PSoC Creator IDE for development and debugging the applications, and PSoC Programmer for programming hex files.
- The [Kit Operation chapter on page 19](#) describes the major features of the PSoC 4100PS Prototyping Kit and functionalities such as programming, debugging, and the USB-UART and USB-I2C bridges.
- The [Code Examples chapter on page 25](#) describes multiple code examples that will help you understand how to create your own PSoC 4100PS projects.
- The [Appendix chapter on page 30](#) describes the hardware content of the kit and the hardware operation and also provides schematics, details about programming the kit using MiniProg3, Kit Schematics, and the bill of materials (BOM).

1.4 Additional Learning Resources

Cypress provides a wealth of data at www.cypress.com to help you to select the right PSoC device for your design, and to help you to quickly and effectively integrate the device into your design. For a comprehensive list of resources, see [KBA86521](#), [How to Design with PSoC 3](#), [PSoC 4](#), and [PSoC 5LP](#). The following is an abbreviated list for PSoC 4:

- Overview: [PSoC Portfolio](#) and [PSoC Roadmap](#).
- Product Selectors: [PSoC 4 Product Selector](#). In addition, [PSoC Creator](#) includes a device selection tool.
- Datasheets: Describe and provide electrical specifications for the [PSoC 4000](#), [PSoC 4100](#), [PSoC 4200](#), [PSoC 4100M](#), [PSoC 4200M](#), [PSoC 4200L](#) and [PSoC 4000S](#) device families.
- [CapSense Design Guide](#): Learn how to design capacitive touch-sensing applications with the PSoC 4 family of devices.
- [Application Notes](#) and [Code Examples](#): Cover a broad range of topics, from basic to advanced. Many of the application notes include code examples. Visit the [PSoC 3/4/5 Code Examples](#) web page for a list of all available PSoC Creator code examples. To access code examples from within PSoC Creator - see [PSoC Creator Code Examples on page 9](#).
- [Technical Reference Manuals \(TRM\)](#): Provide detailed descriptions of the architecture and registers in each PSoC 4 device family.
- [Development Kits](#):
 - [CY8CKIT-041](#), [CY8CKIT-046](#), [CY8CKIT-044](#), [CY8CKIT-042](#), and [CY8CKIT-040](#) are easy-to-use and inexpensive development platforms. These kits include connectors for Arduino™ compatible shields and Digilent Pmod Peripheral Modules.
 - [CY8CKIT-043](#), [CY8CKIT-049](#), [CY8CKIT-145](#), [CY8CKIT-146](#), and [CY8CKIT-149](#) are very low-cost prototyping platforms for sampling PSoC 4 devices.
 - [CY8CKIT-001](#) is a common development platform for all PSoC family devices.
 - The [MiniProg3](#) device provides an interface for flash programming and debug.
- [Knowledge Base Articles \(KBA\)](#): Provide design and application tips from experts on using the device.
- PSoC Creator Training: Visit www.cypress.com/go/creatorstart/creatortraining for a comprehensive list of video training on PSoC Creator.
- Learning from Peers: Visit www.cypress.com/forums to meet enthusiastic PSoC developers discussing the next-generation embedded systems on Cypress Developer Community Forums.

1.5 Technical Support

For assistance, visit [Cypress Support](#) or contact customer support at +1 (800) 541-4736 Ext. 3 (in the USA) or +1 (408) 943-2600 Ext. 3 (International).

You can also use the following support resources if you need quick assistance:

- [Self-help \(Technical Documents\)](#)
- [Local Sales Office Locations](#)

1.6 Document Conventions

Table 1-1. Document Conventions for Guides

Convention	Usage
Courier New	Displays file locations, user entered text, and source code: C:\...cd\icc\
<i>Italics</i>	Displays file names and reference documentation: Read about the <i>sourcefile.hex</i> file in the <i>PSoC Creator User Guide</i> .
[Bracketed, Bold]	Displays keyboard commands in procedures: [Enter] or [Ctrl] [C]
File > Open	Represents menu paths: File > Open > New Project
Bold	Displays commands, menu paths, and icon names in procedures: Click the File icon and then click Open .
Times New Roman	Displays an equation: $2 + 2 = 4$
Text in gray boxes	Describes Cautions or unique functionality of the product.

1.7 Acronyms

Table 1-2. Acronyms Used in this Document

Acronym	Description
ADC	Analog-to-Digital Converter
BCP	Bridge Control Panel
BLE	Bluetooth Low Energy
BOM	Bill of Materials
CE	Code Example
CMOD	Modulator Capacitor
CMP	Comparator
CTANK	Shield tank capacitor
DAC	Digital to Analog Converter
DPDT	Double-Pole, Double-Throw
ESD	Electrostatic Discharge
GPIO	General Purpose Input/Output
I2C	Inter-Integrated Circuit
IDAC	Current DAC
IDE	Integrated Design Environment
KBA	Knowledge Based Article
LED	Light-Emitting Diode
PSoC	Programmable Systems-on-Chip
SAR	Successive Approximation Register
SCB	Serial Communication Block
SRAM	Static Random Access Memory
SWD	Serial Wire Debug
TCPWM	Timer, Counter, Pulse Width Modulator
UART	Universal Asynchronous Receiver Transmitter
USB	Universal Serial Bus
WCO	Watch Crystal Oscillator

2. Software Installation



This chapter describes the steps to install the software tools and packages on a PC for using the PSoC 4100PS Prototyping Kit. This includes the IDE on which the projects will be built and used for programming.

2.1 Before You Begin

All Cypress software installations require administrator privileges, but these are not required to run the software after it is installed. Close any other Cypress software that is currently running before installing the kit software.

2.2 Install Software

Follow these steps to install the PSoC 4100PS Prototyping kit software:

1. Download the PSoC 4100PS Prototyping kit software from www.cypress.com/CY8CKIT-147. The kit software is available in three formats for download.
 - a. **CY8CKIT-147 Kit Only:** This executable file installs only the kit contents, which include kit code examples, hardware files, and user documents. This package can be used if all the software prerequisites (listed in step 5) are installed on your PC.
 - b. **CY8CKIT-147 Kit Setup:** This installation package contains the files related to the kit including PSoC Creator and PSoC Programmer. However, it does not include the Windows Installer or Microsoft .NET framework packages. If these packages are not on your computer, the installer directs you to download and install them from the Internet.
 - c. **CY8CKIT-147 DVD ISO:** This file is a complete package, stored in a DVD-ROM image format, that you can use to create a DVD or extract using an ISO extraction program such as WinZip or WinRAR. The file can also be mounted like a virtual CD/DVD using virtual drive programs such as Virtual CloneDrive and MagicISO. This file includes all the required software, utilities, drivers, hardware files, and user documents.
2. If you have downloaded the ISO file, mount it in a virtual drive. Extract the ISO contents if you do not have a virtual drive to mount. Double-click *cyautorun.exe* in the root directory of the extracted content or mounted ISO if "Autorun from CD/DVD" is not enabled on the PC. The installation window will appear automatically.

Note: If you are using the "Kit Setup" or "Kit Only" file, then go to step 4 for installation.

3. Click **Install CY8CKIT-147 Kit** to start the kit installation, as shown in [Figure 2-1](#).

Figure 2-1. Kit Installer Screen



4. Select the directory in which you want to install the PSoC 4100PS Prototyping kit-related files. Choose the directory and click **Next**.
5. When you click **Next**, the PSoC 4100PS Prototyping kit installer automatically installs the required software, if it is not present on your computer. The following is the required software:
 - a. PSoC Creator 4.2 or later: This software is also available separate from the kit at www.cypress.com/psoccreator.
 - b. PSoC Programmer 3.27.1 or later: This is installed as part of PSoC Creator installation (www.cypress.com/programmer).

- Choose the **Typical/Custom/Complete** installation type in the Product Installation Overview window, as shown in [Figure 2-2](#). Click **Next** after you select the installation type.
Note: We recommend to do typical installation, however user can choose according to their requirement.

Figure 2-2. Product Installation Overview

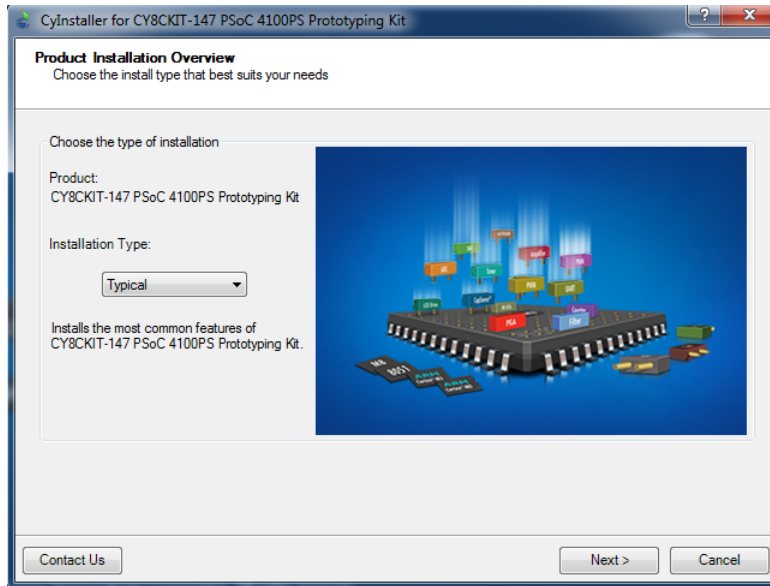

- Read the License agreement and select 'I accept the terms in the license agreement' to continue with installation. Click on **Next**.
- When the installation begins, a list of packages appears on the installation page. A green check mark appears next to each package after successful installation.
- Enter your contact information or select the check box **Continue Without Contact Information**. Click **Finish** to complete the PSoC 4100PS Prototyping kit installation.
- After the installation is complete, the kit contents are available at the following location:
`<Install_Directory>\CY8CKIT-147 PSoC 4100PS Prototyping Kit`

Default location:

Windows OS (64-bit):

`C:\Program Files (x86)\Cypress\CY8CKIT-147 PSoC 4100PS Prototyping Kit`

Windows OS (32-bit):

`C:\Program Files\Cypress\CY8CKIT-147 PSoC 4100PS Prototyping Kit`

Note: For Windows 7/8/8.1 and later users, the installed files and the folder are read-only. To use the installer code examples, follow the steps outlined in the [Code Examples chapter on page 25](#).

2.3 Installing PSoC 4100PS Device in PSoC Creator

Below steps need to be followed in order to install 4100PS device into PSoC Creator

1. Run PSoC Creator 4.2.
2. Go to **Tools > Find new devices in PSoC Creator**. The Device Update Installer window will pop-up.

Figure 2-3. Device Update Installer

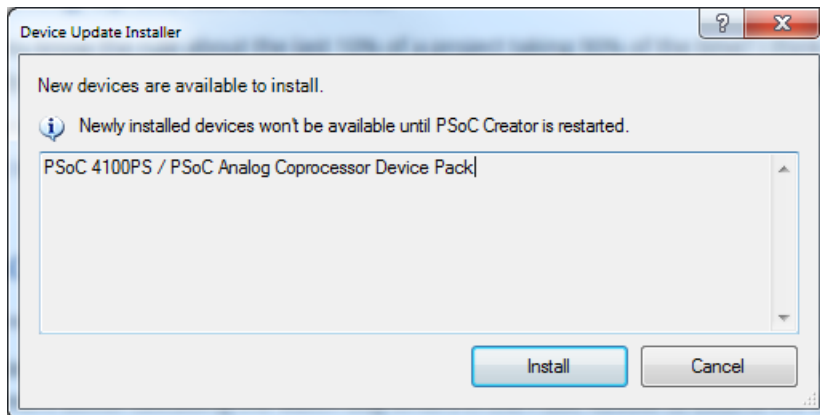

3. Click on the **Install** Button.
4. Restart PSoC Creator. Note that this is an important step. The devices will only be available after PSoC Creator is restarted.

The devices should now be available in the device selector when you create a new project.

2.4 Uninstall Software

The software can be uninstalled using one of the following methods:

1. Go to **Start > All Programs > Cypress > Cypress Update Manager** and select the Uninstall button.
2. Go to **Start > Control Panel > Programs and Features for Windows 7** or **Add/Remove Programs for Windows XP**; select the **Uninstall/Change** button.

3. Kit Operation



This chapter introduces you to the different features of the PSoC 4100PS Prototyping kit. This primarily includes the programming/debugging functionality, KitProg2 USB-UART and USB-I2C bridges, and the method to update the KitProg2 firmware.

3.1 Theory of Operation

Figure 3-1 shows the block diagram for the PSoC 4100PS Prototyping kit.

Figure 3-1. Block Diagram of PSoC 4100PS Prototyping kit

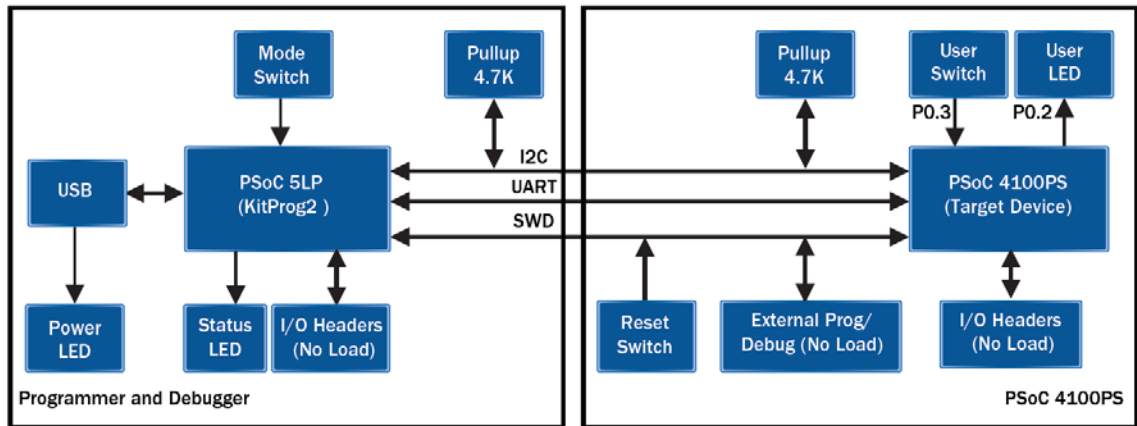

The PSoC 4100PS Prototyping kit is simplistic in design and focuses on providing you with complete access to develop applications using the PSoC 4100PS device family. This kit supports the following features:

- **PSoC 4100PS I/O Headers:** The PSoC 4100PS Prototyping board brings all GPIOs of the target PSoC 4100PS device to the two expansion headers, enabling the user to have maximum access to the capabilities of the PSoC 4100PS device.
- **User LED:** The on-board LED can be used to display outputs from the PSoC 4100PS device. This includes modulating the brightness of the LED to notify different states of the device.
- **User Button:** This kit has a push button, which can be used to provide an input to the PSoC 4100PS.

Note: The switch connects the PSoC 4100PS pin to ground when pressed. Therefore, you need to configure the PSoC 4100PS pin as 'resistive pull-up' for detecting the switch press. Also note when configuring the pin as 'resistive pull-up', the pin cannot be connected to any other internal peripheral through hardware connection.

- **Reset Button:** This button is used to reset the PSoC 4100PS device when pressed.
- **Power LED:** This LED indicates power is being applied to the board.
- **PSoC 4100PS Device:** This is the target device (CY8C4145LQI-PS433) on the board.
- **10-pin/5-pin Programming Header:** These are external programming headers that can be used to program the PSoC 4100PS using a MiniProg3. Typically this connection is not required since the kit contains an integrated KitProg2.
- **PSoC 5LP IO Headers:** Using these headers, you can evaluate the PSoC 5LP device. The PSoC 5LP is used to implement the KitProg2 functionality by default.
- **Current Measurement Jumper:** Using this jumper, you can measure the current consumed by the device. This jumper is not populated by default. To use this jumper, zero ohm resistor R31 must be removed.
- **USB Connector:** Using this connector, you can connect the kit to a PC directly through a USB port.
- **KitProg2:** An on-board programmer/debugger utilizing a PSoC 5LP (CY8C5868LTI-LP039), which enables you to program and debug the target PSoC 4100PS device. It can also act as a USB-UART and UART-I2C bridge.
When used as a standalone module, it can be used to program devices of the PSoC 3, PSoC 4, or PSoC 5LP families through the SWD interface. For more details on the KitProg2 functionality, refer to the [KitProg2 User Guide](#).
- **KitProg2 Mode Selection Button:** This button is used to switch between the KitProg2 modes. You can also use this button to provide an input to the PSoC 5LP in custom applications. Note that the switch connects the PSoC 5LP pin to ground when pressed. Refer to the [KitProg2 User Guide](#) for more details.
- **KitProg2 Status LED:** This LED gives the programming/mode status of KitProg2.

Table 3-1. KitProg2 Mode Switching

KitProg2 Programming Modes *	Status LED (LED3)
KitProg2 Program/Debug Mode (PPCOM mode) (default)	ON
CMSIS-DAP & Mass Storage Programming Mode	OFF

***Note:** Toggling between the Programming modes can be done by pressing SW3 Mode switch.

3.2 Programming and Debugging the PSoC 4100PS Target Device

The target PSoC 4100PS device can be programmed and debugged using the KitProg2. Before programming the device, ensure that PSoC Creator and PSoC Programmer software are installed on the PC. See [Install Software on page 15](#) for more information.

3.2.1 Programming Using PSoC Creator

1. Connect the prototyping board to the computer through the PCB finger connector (J8), as shown in [Figure 3-2](#). The kit enumerates as a composite device. If you are plugging in the PSoC 4100PS Prototyping Kit to your PC for the first time, the kit drivers will get installed automatically. Successful enumeration is indicated by Amber Status LED (LED3) ON. If the Amber Status LED (LED3) is not ON, refer to the [KitProg2 User Guide](#) for details on the KitProg2 status and troubleshooting instructions.

Figure 3-2. Connecting the PSoC 4100PS Prototyping Kit to a Computer

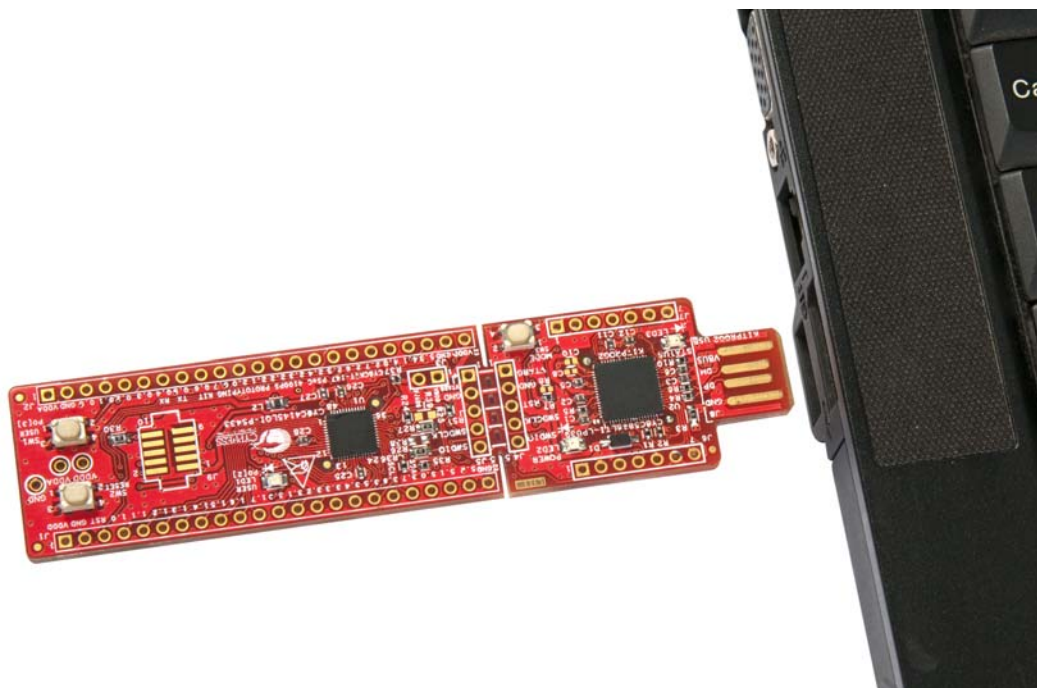

2. Open the desired project in PSoC Creator. From inside PSoC Creator, go to **File > Open > Project/Workspace**. This provides the option to browse and open a previously saved project. If you want to open one of the code examples provided with the kit, follow the instructions in the [Code Examples chapter on page 25](#).

3. Select the option **Build > Build <Project_Name>** or press [Shift] [F6] to build the project as shown in [Figure 3-3](#).

Figure 3-3. Build an Code Example

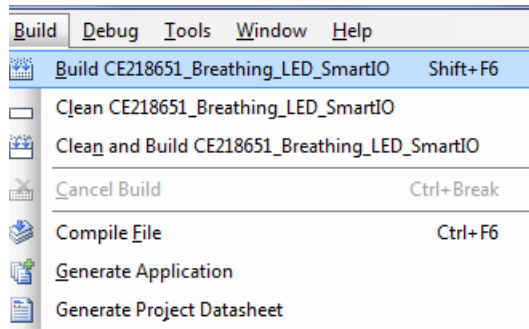

4. If there are no errors during build, program the firmware into the kit by choosing **Debug > Program** or press [Ctrl] [F5], as shown in [Figure 3-4](#). This programs the target PSoC 4100PS device on the PSoC 4100PS Prototyping kit, and the kit is ready to use.

Figure 3-4. Programming Device From PSoC Creator

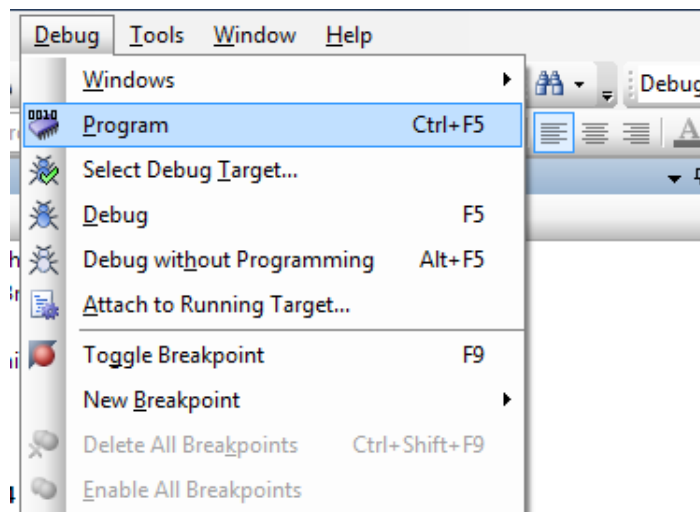

3.2.2 Debugging Using PSoC Creator

For debugging the project using PSoC Creator, follow steps 1–3 from [Programming Using PSoC Creator on page 21](#) followed by:

1. Click on the **Debug** icon  or press [F5]. Alternatively, you can use the option **Debug > Debug**.
2. Once the PSoC Creator opens in Debug mode, use the buttons on the toolbar to debug your application.

For more details on using the debug features, refer to section “Debugging Using PSoC Creator” of the [KitProg2 User Guide](#).

3.2.3 Programming Using PSoC Programmer

PSoC Programmer (3.27.1 or later) can be used to program existing `.hex` files into the PSoC 4100PS Prototyping kit. Refer to the **Programming Using PSoC Programmer** section in the [KitProg2 User Guide](#) for a detailed explanation on how to program using PSoC Programmer.

3.2.4 Mass Storage Programming

The KitProg2 in the PSoC 4100PS Prototyping board supports programming through a USB Mass Storage interface. This interface allows you to program the PSoC 4100PS device by copying `.hex` files into an emulated USB Mass Storage device. For more details on using KitProg2 as a Mass Storage Programmer, refer to the [KitProg2 User Guide](#).

3.3 USB-UART Bridge

The KitProg2 on the PSoC 4100PS Prototyping Kit can act as a USB-UART bridge. The UART lines between the KitProg2 and the target are hard-wired on the board, through the snappable area, with UART_RX assigned to **P0[4]** and UART_TX assigned to **P0[5]** on PSoC 4100PS (target). For more details on the KitProg2 USB-UART functionality, refer to **USB-UART Bridge** section in [KitProg2 User Guide](#).

Figure 3-5. UART Connection between KitProg2 and PSoC 4100PS

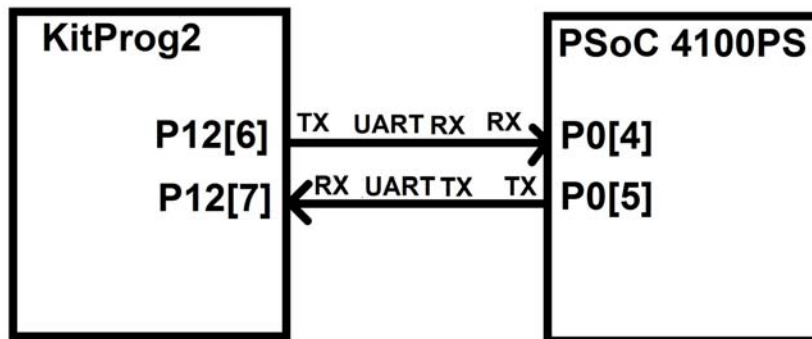

3.4 USB-I2C Bridge

The KitProg2 can function as a USB-I2C bridge and communicate with the software utility, Bridge Control Panel (BCP). The I2C lines on PSoC 4100PS (target) device are **P3[7] (SDA)** and **P3[6] (SCL)**, which are hardwired on the board to the I2C lines of the KitProg2. The USB-I2C supports I2C speeds of 50 kHz, 100 kHz, 400 kHz, and 1 MHz. For more details on the KitProg2 USB-I2C functionality, refer to **USB-I2C Bridge** section in [KitProg2 User Guide](#).

Figure 3-6. I2C Connection between KitProg2 and PSoC 4100PS

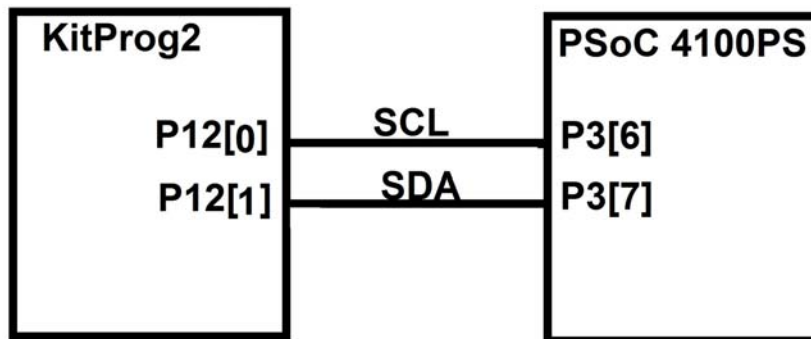

3.5 Updating the KitProg2 Firmware

The KitProg2 firmware normally does not require any update. You can use the PSoC Programmer software to update the KitProg2 firmware if necessary. Refer to **Updating the KitProg2 Firmware** in the [KitProg2 User Guide](#) for a detailed explanation on how to update the KitProg2 firmware.

4. Code Examples



This chapter explains the code examples provided along with the PSoC 4100PS Prototyping kit. To access these code examples, download and install the CY8CKIT-147 PSoC 4100PS Prototyping kit setup file from the kit web page: www.cypress.com/CY8CKIT-147. After installation, the code example can be accessed from the PSoC Creator **Start** Page as shown in [Figure 4-1](#).

4.1 Using the Kit Code Examples

Follow these steps to open and use the example projects.

1. Launch PSoC Creator from the Windows Start menu (**Start > All Programs > Cypress > PSoC Creator <version> > PSoC Creator <version>**).
2. On the **Start** page, click on **CY8CKIT-147** under **Start > Kits**. A list of code examples appears, as shown in [Figure 4-1](#).
3. Click on the desired code example and save it at a desired location. For the remaining steps, *CE218651_Breathing_LED_SmartIO.cywrk* is used as a reference.

Figure 4-1. Open Code Example from PSoC Creator

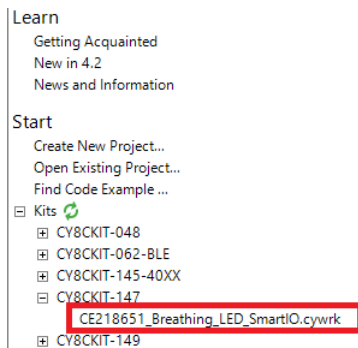

4. Build the code example by choosing **Build > Build <Project Name>**, as shown in [Figure 4-2](#). A *.hex* file is generated after a successful build process.

Figure 4-2. Build Code Example from PSoC Creator

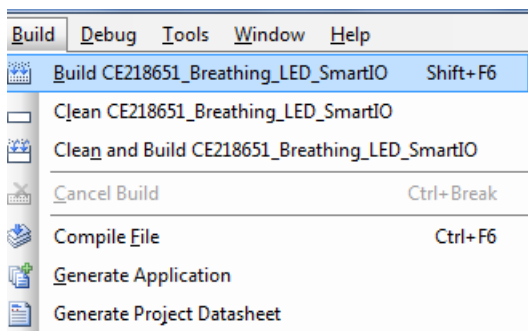

5. Connect the PSoC 4100PS Prototyping kit to the PC using the KitProg2 PCB finger connector, J8 as described in [Programming Using PSoC Creator chapter on page 21](#) to program the kit with this code example. If this is the first time the kit is connected to the PC, you should wait for driver installation to complete before proceeding with the next step.
6. Choose **Debug > Program** in PSoC Creator as shown in [Figure 4-3](#).

Figure 4-3. Program Device in PSoC Creator

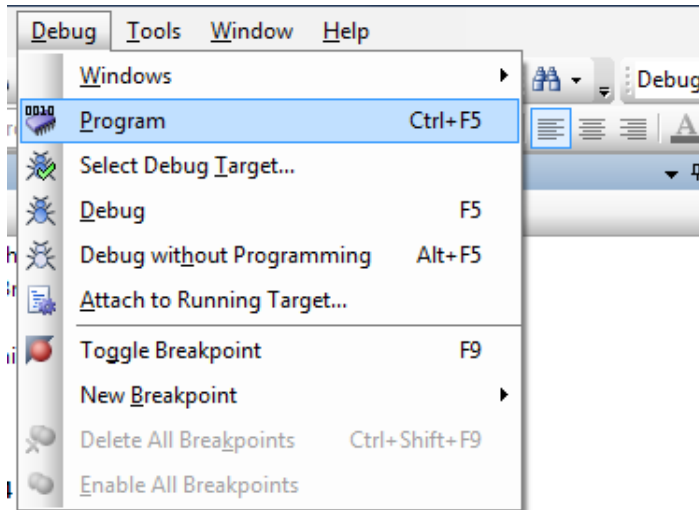

7. If the device is already acquired, programming will complete automatically and the result will appear in the PSoC Creator status bar at the bottom left side of the screen. If the device is yet to be acquired, the Select Debug Target window will appear. Select **KitProg2/<serial number>** and click the **Port Acquire** button, as shown in [Figure 4-4](#).

Figure 4-4. Port Acquire

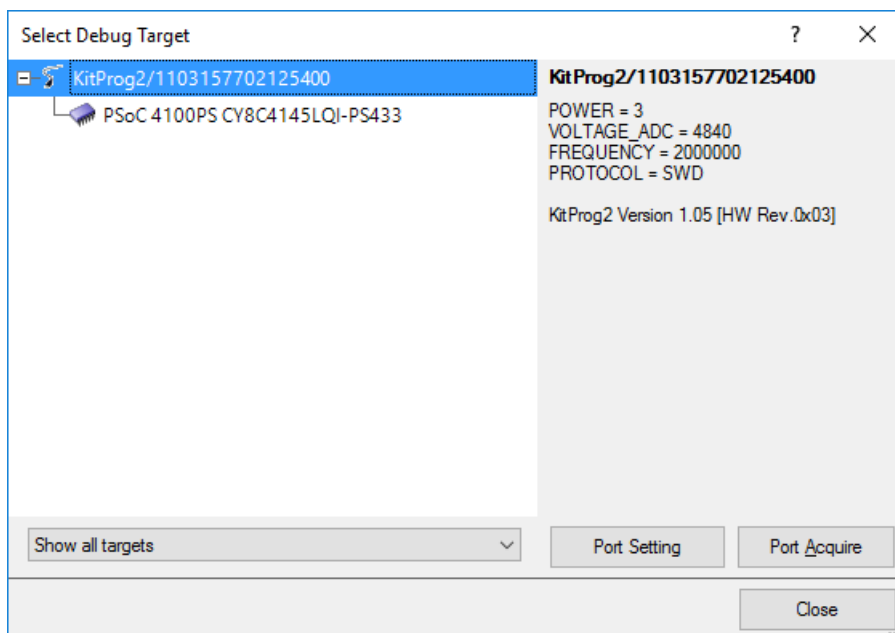

- After the device is acquired, it is shown in a tree structure below the **KitProg2/<serial number>**. Click the **OK / Connect** button to exit the window and start programming, as shown in [Figure 4-5](#).

Figure 4-5. Connect Device From PSoC Creator and Program

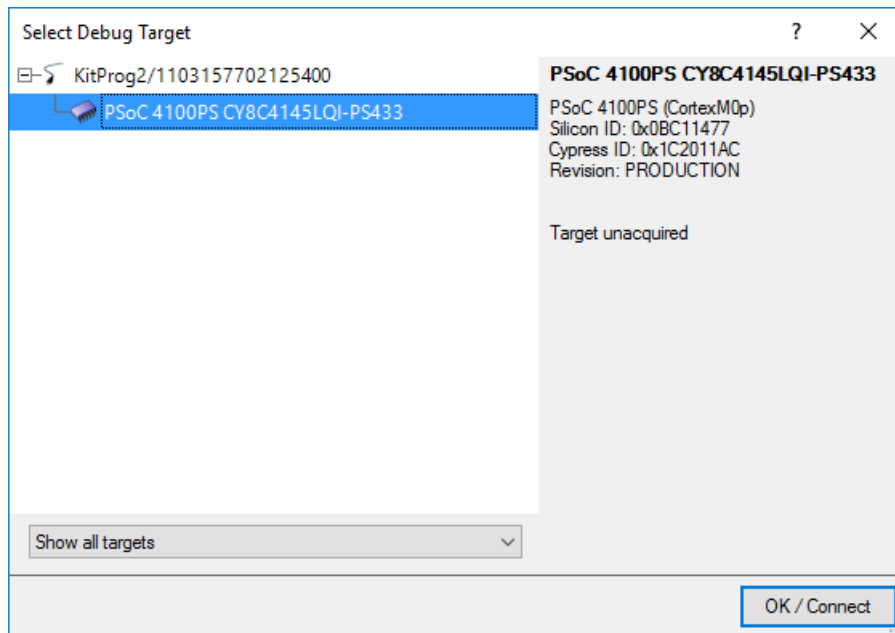

- From the workspace explorer in PSoC Creator, open the *CE218651_Breathing_LED_SmartIO.pdf* as shown in [Figure 4-6](#).

Figure 4-6. Project Datasheet - CE218651_Breathing_LED_SmartIO.pdf

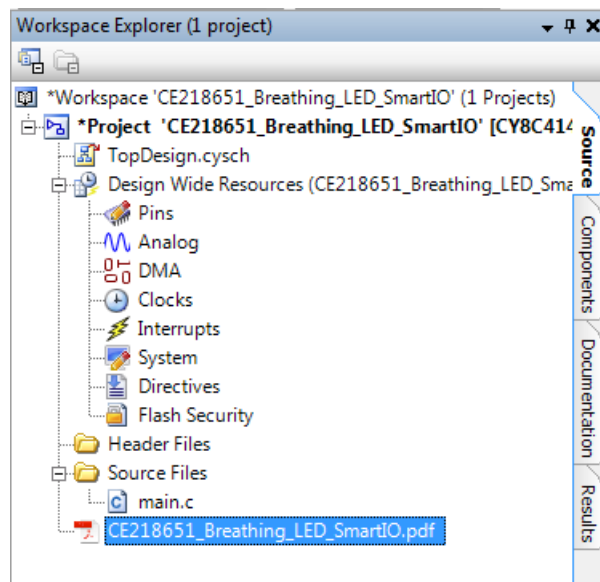

4.2 Using Built-in PSoC Creator Code Examples with the Kit

Follow these steps to open and use the built-in PSoC Creator examples.

1. Launch PSoC Creator from **Start > All Programs > Cypress > PSoC Creator<version> > PSoC Creator <version>**.
2. On the Start Page, click **Find Code Example...** under **Start**, or use the menu item "**File > Code Example...**" as shown in [Figure 4-7](#).

Figure 4-7. PSoC Creator Find Code Example...

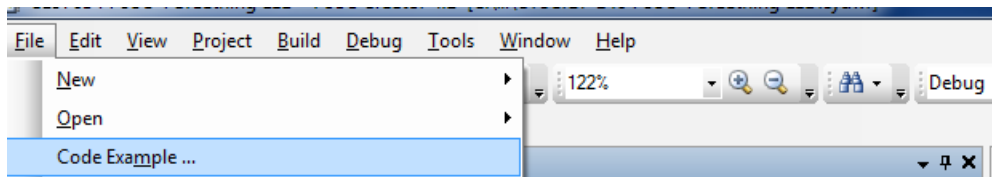

3. In the Find Code Example window, set the **Device family** to **PSoC 4100PS** as shown in [Figure 4-8](#).

Figure 4-8. Selecting PSoC 4100PS Device Family in Find Code Example Window

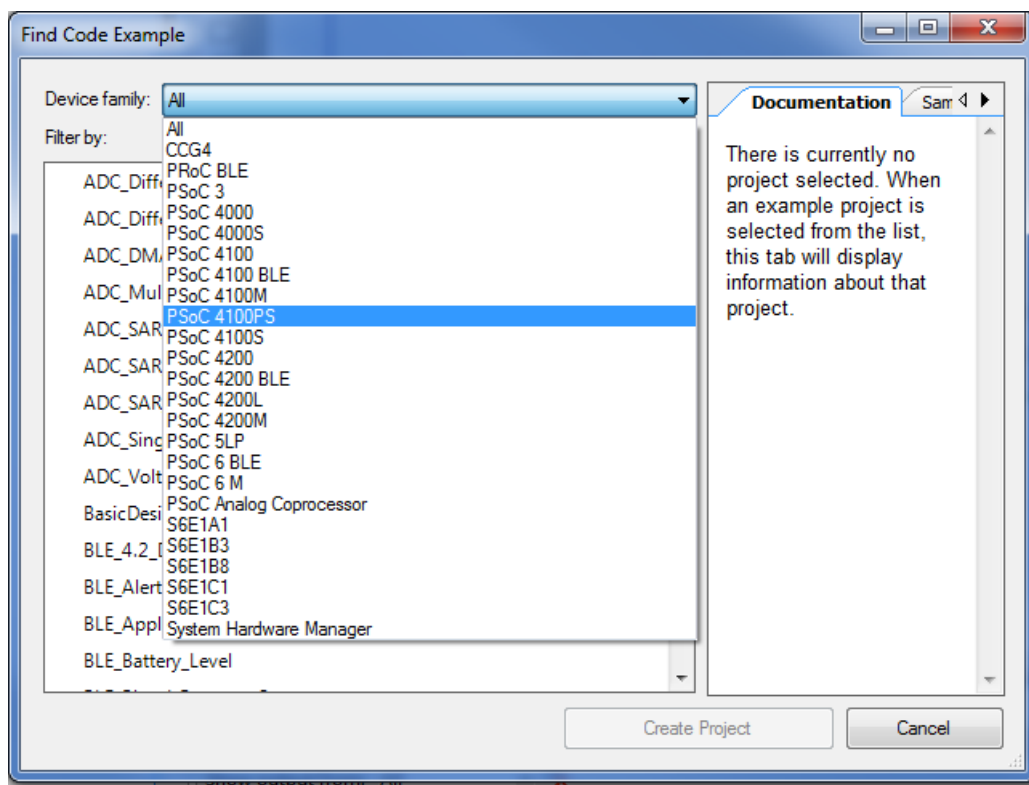

4. You can use any project that appears in the list with the kit. As an example, we will select the **CE218651_Breathing_LED_SmartIO** project and see how to use it with the CY8CKIT-147 kit.

5. Select the **CE218651_Breathing_LED_SmartIO** project and click the **Create Project** button as shown in [Figure 4-9](#) button. Save the workspace to a desired location.

Figure 4-9. CE218651_Breathing_LED_SmartIO Code Example

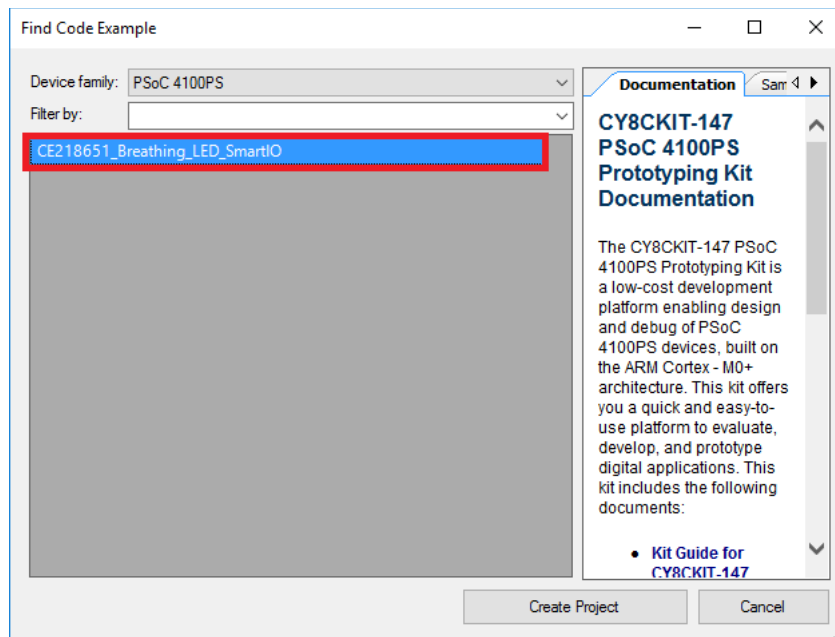

6. Open **CE218651_Breathing_LED_SmartIO.pdf** from the Workspace Explorer to learn more about the code example and its configuration. See [Figure 4-10](#).

Figure 4-10. Project Datasheet: CE218651_Breathing_LED_SmartIO

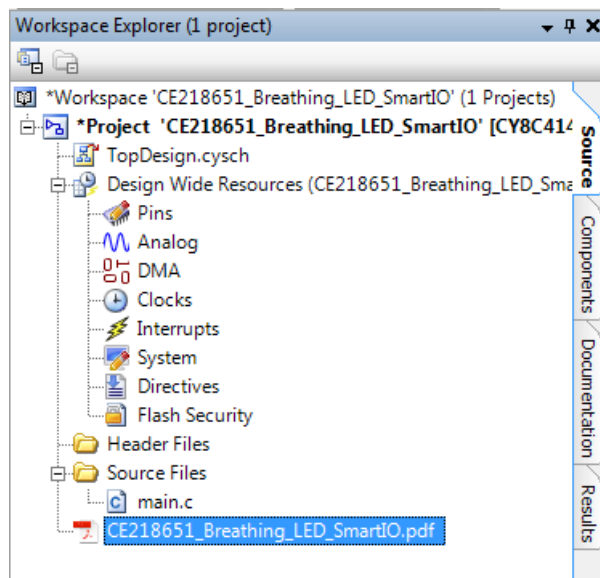

A.1 Board Details

The PSoC 4100PS Prototyping kit consists of the following blocks:

- PSoC 4100PS device (CY8C4145LQI-PS433)
- PSoC 4100PS I/O headers J1 and J2
- 10-pin PSoC 4100PS Program/Debug header, J9 (foot-print only)
- KitProg2 (PSoC 5LP) device (CY8C5868LTI-LP039)
- KitProg2 I/O headers J6 and J7
- SWD connection headers J4 and J5
- PCB USB finger connector J8
- One amber LED, LED2 (Power)
- One amber LED, LED3 (KitProg2 Status)
- One blue LED, LED1 (User)
- One Push Button SW1 (User)
- One Push Button SW2 (Reset)
- One Push Button SW3 (KitProg2 Mode)
- Current Measurement Jumper J3 (foot-print only) (shorted by zero ohm resistor R31)
- Perforated 'snappable' board design

Figure A-1. PSoC 4100PS Prototyping kit Pin Details

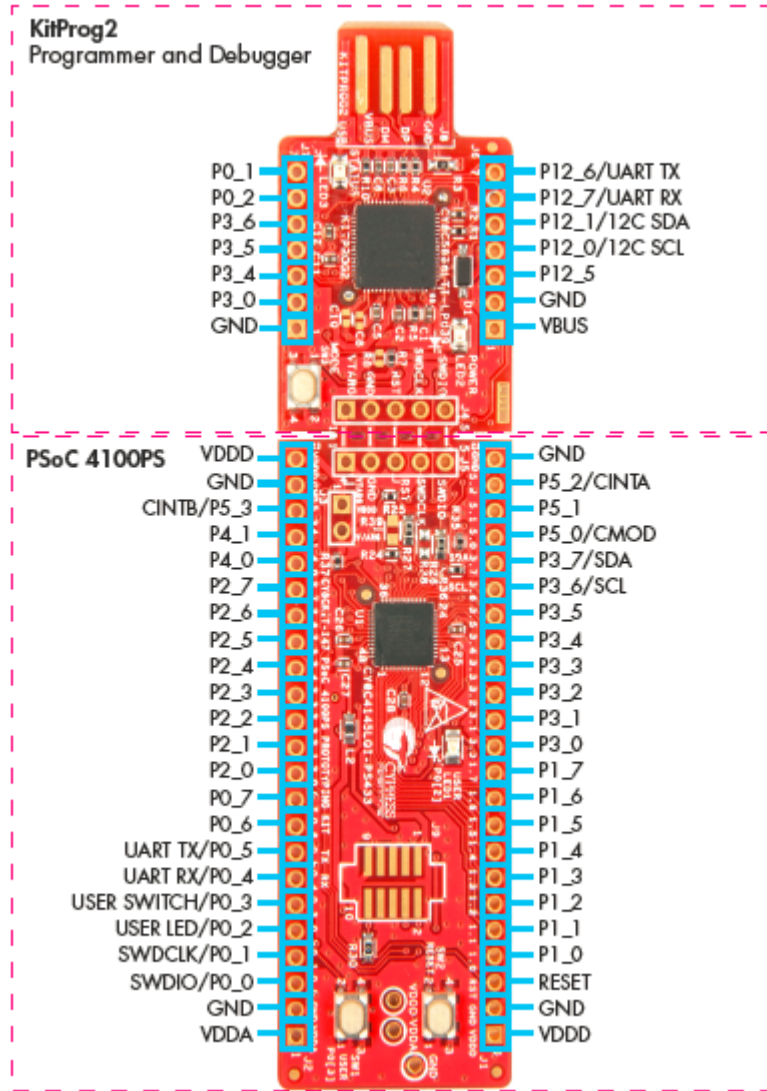

A.2 Hardware Details

A.2.1 Target Board

The target board uses the PSoC 4100PS device. PSoC 4100PS is a scalable and reconfigurable platform architecture for a family of programmable embedded system controllers with an ARM Cortex-M0+ CPU. It combines programmable and reconfigurable digital blocks with flexible automatic routing. The PSoC 4100PS device family, based on this platform architecture, is a combination of a microcontroller with digital programmable logic, programmable interconnect, and standard communication and timing peripherals. The PSoC 4100PS products will be fully compatible with members of the PSoC 4 platform for new applications and design needs. The digital subsystems allow flexibility and in-field tuning of the design. For more information, refer to the [PSoC 4100PS kit web page](#) and the [PSoC 4100PS Family Datasheet](#).

Figure A-2. Schematic of PSoC 4 (Target)

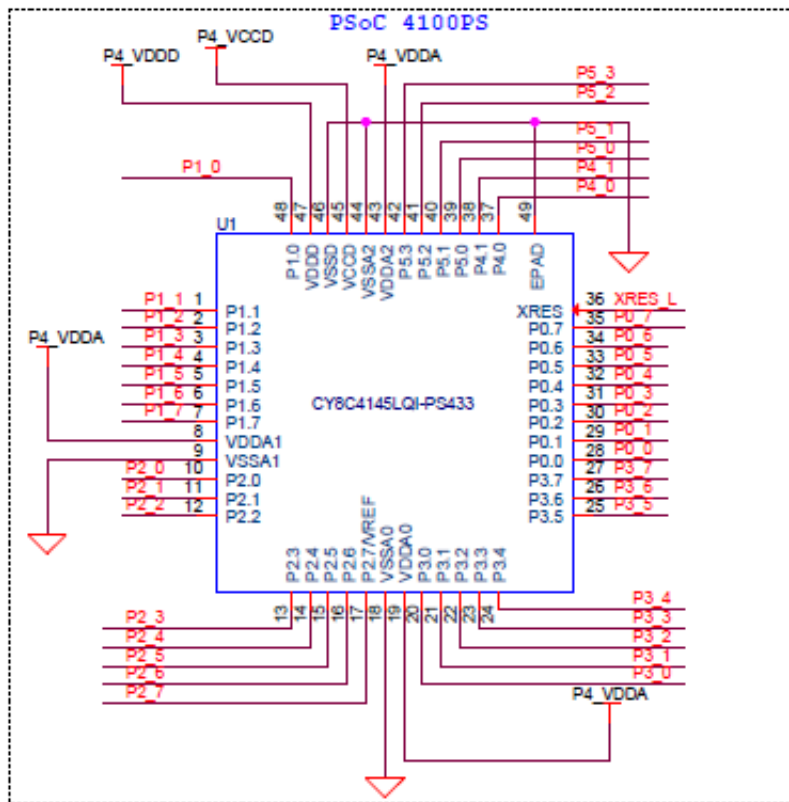

A.2.3 Power Supply System

The power supply system on this board is dependent on the source of the power. For most applications, you can use the 5 V supply from the USB connection to power the system. You can also connect an external power supply to the board for low-voltage applications. The kit supports the following connections:

- 5 V from the KitProg2 USB (J8)
- 1.8 V to 5 V from a regulated supply connected to VTARG or VDDD

Note: In order to use an external power supply with the KitProg2 also connected to the PC USB, first remove diode D1 from the board. This ensures that the VTARG supply from KitProg2 is not supplied to the target device. KitProg2 measures the target voltage and adjusts the logic levels on the programming pins accordingly.

It is important to understand that this prototyping kit does not have any onboard ESD protection circuitry. Therefore, the power source for the PSoC 4100PS Prototyping kit must be of a high quality to ensure that the board is protected from any over-current conditions and swapped-power connections.

A.2.3.1 Measure PSoC 4100PS Current Consumption

You can measure current consumption of the PSoC 4100PS device by following the steps below.

1. Remove the resistors R31, R3 and install a 2-pin jumper in the supplied holes of J3.
2. Connect an ammeter across the 2-pin jumper to measure the current to the PSoC 4100PS device.

After measuring the current consumption, populate resistors R31 and R3 or place a shorting jumper across the two jumper pins for normal operation of the kit.

A.2.4 Board Separation (Snapping)

The PSoC 4100PS Prototyping kit consists of a PSoC 4100PS and a KitProg2 board. To separate the two boards for evaluation or development, break the two boards apart at the built-in perforated edge between J4 and J5.

The easiest method of separating the two boards is to place the kit on the edge of a table, where the edge of the table is directly below the perforated edge and the smaller KitProg2 board is off the table edge. Press gently on the KitProg2 board and snap the two boards apart. If any material is removed from the edge of the boards, use sheers to clean up the edge of the kit.

Note that once the boards are separated, direct UART and I2C connections between the PSoC 4100PS device and KitProg2 are lost. This is because the traces connecting the UART and I2C lines are cut off during the separation. However, you can access KitProg2's UART and I2C lines through header J6.

Figure A-4. PSoC 4100PS Prototyping kit Broken into Two Parts

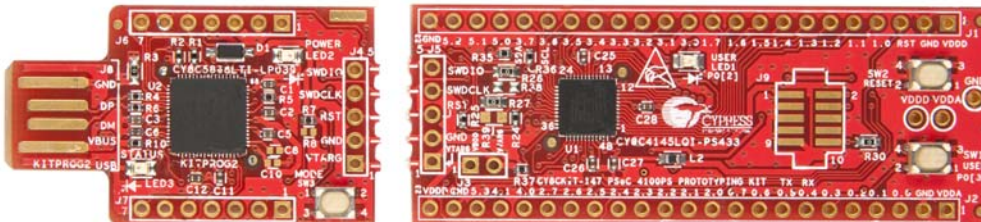

A.2.5 Header Connections

The PSoC 4100PS Prototyping kit supports a number of unpopulated headers on both the KitProg2 and the target PSoC 4100PS boards.

A.2.5.1 *Functionality of the J1 and J2 Headers (Target Board)*

The target PSoC 4100PS board contains two single-inline headers (J1 and J2). These headers are both 1×23-pin headers and include all of the I/Os available on the PSoC 4100PS device. These headers support all of the available ports, GND, VDDD, VDDA, and connections to passive elements and user-input devices.

The J1 and J2 headers support 100-mil spacing, so you can solder connectors to connect the target board to a development breadboard.

Figure A-5. J1 and J2 Headers

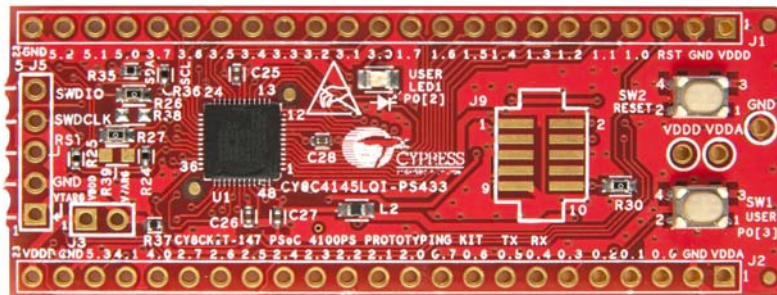

Table A-1. J1 Header Pin Details

PSoC 4100PS Prototyping kit GPIO Header J1		
Pin	Signal	Description
J1_01	VDDD	Power
J1_02	GND	Ground
J1_03	RST	Reset
J1_04	P1[0]	GPIO
J1_05	P1[1]	GPIO
J1_06	P1[2]	GPIO
J1_07	P1[3]	GPIO
J1_08	P1[4]	GPIO
J1_09	P1[5]	GPIO
J1_10	P1[6]	GPIO
J1_11	P1[7]	GPIO
J1_12	P3[0]	GPIO
J1_13	P3[1]	GPIO
J1_14	P3[2]	GPIO
J1_15	P3[3]	GPIO
J1_16	P3[4]	GPIO
J1_17	P3[5]	GPIO
J1_18	P3[6]	GPIO / SCL
J1_19	P3[7]	GPIO / SDA
J1_20	P5[0]	GPIO / CMOD
J1_21	P5[1]	GPIO
J1_22	P5[2]	GPIO / CINTA
J1_23	GND	Ground

Table A-2. J2 Header Pin Details

PSoC 4100PS Prototyping kit GPIO Header J2		
Pin	Signal	Description
J2_01	VDDA	Power
J2_02	GND	Ground
J2_03	P0[0]	GPIO / SWDIO
J2_04	P0[1]	GPIO / SWDCLK
J2_05	P0[2]	GPIO / User LED
J2_06	P0[3]	GPIO / User Switch
J2_07	P0[4]	GPIO / UART_RX
J2_08	P0[5]	GPIO / UART_TX
J2_09	P0[6]	GPIO
J2_10	P0[7]	GPIO
J2_11	P2[0]	GPIO
J2_12	P2[1]	GPIO
J2_13	P2[2]	GPIO
J2_14	P2[3]	GPIO
J2_15	P2[4]	GPIO
J2_16	P2[5]	GPIO
J2_17	P2[6]	GPIO
J2_18	P2[7]	GPIO
J2_19	P4[0]	GPIO
J2_20	P4[1]	GPIO
J2_21	P5[3]	GPIO / CINTB
J2_22	GND	Ground
J2_23	VDDD	Power

A.2.5.2 Functionality of J4 and J5 Headers (PSoC 4100PS to KitProg2)

The KitProg2 and target boards each contain a 1x5-pin header. These headers provide a physical connection between the two devices. Specifically, the connection includes the SWD interface, required to program/debug the target PSoC 4100PS device, power, ground, and reset.

Figure A-6. J4 and J5 Headers

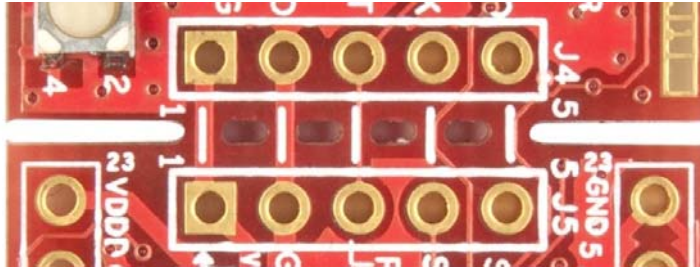

Table A-3. Pin Details of J4 Header

PSoC 5LP (J4)		
Pin	Signal	Description
J4_01	VTARG	Power
J4_02	GND	Ground
J4_03	P12.4	Reset
J4_04	P12.3	SWD_CLK
J4_05	P12.2	SWD_IO

Table A-4. Pin Details of J5 Header

PSoC 4100PS (J5)		
Pin	Signal	Description
J5_01	VTARG	Power
J5_02	GND	Ground
J5_03	XRES	Reset
J5_04	P3.3	SWD_CLK
J5_05	P3.2	SWD_IO

When the boards are separated, the KitProg2 board can be used to program any other PSoC 3, PSoC 4, PSoC 5LP family of devices via J4.

A.2.5.3 Functionality of J6 and J7 Headers (KitProg2)

The KitProg2 board contains two single-inline headers (J6 and J7). Both are 1x7-pin-headers, used to pull out several pins of the PSoC 5LP to support advanced features like a low-speed oscilloscope and a low-speed digital logic analyzer. This header also contains the KitProg2 bridge pins that can be used when the two boards are separated.

The J6 and J7 headers support 100-mil spacing, so you can solder connectors to connect the KitProg2 board to a development breadboard.

Figure A-7. J6 and J7 Headers

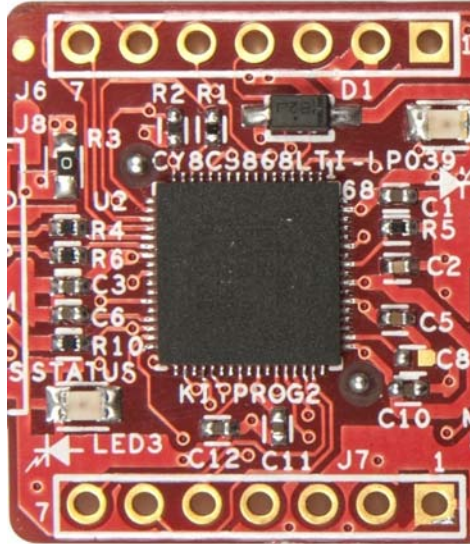

Table A-5. Pin Details of J6

PSoC 5LP KitProg2 Header (J6)		
Pin	Signal	Description
J6_01	VBUS	Power
J6_02	GND	Ground
J6_03	P12.5	GPIO
J6_04	P12.0	GPIO/I2C_SCL
J6_05	P12.1	GPIO/I2C_SDA
J6_06	P12.7	GPIO/UART_RX
J6_07	P12.6	GPIO/UART_TX

Table A-6. Pin Details of J7

PSoC 5LP KitProg2 Header (J7)		
Pin	Signal	Description
J7_01	GND	Ground
J7_02	P3.0	GPIO
J7_03	P3.4	GPIO
J7_04	P3.5	GPIO
J7_05	P3.6	GPIO
J7_06	P0.2	GPIO
J7_07	P0.1	GPIO

A.2.5.4 *Functionality of Connector J8 (USB Finger Connector)*

This connector footprint on the kit enables the user to connect the kit directly to a PC using a USB port.

Figure A-8. USB Type-A connector J8

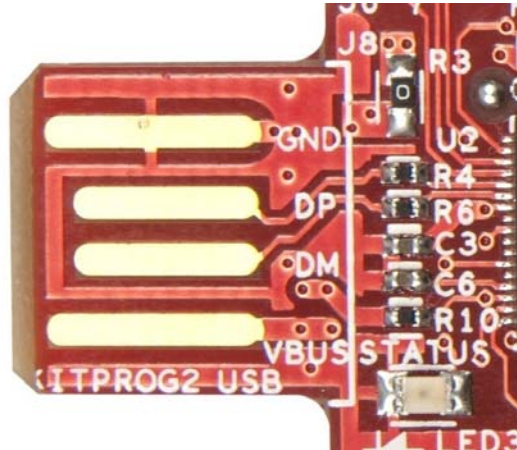

A.2.6 User and Passive Inputs

A.2.6.1 *User Switch*

The target PSoC 4100PS board contains a switch connected to the **P0[3]** pin on the PSoC 4100PS device. This button can be used for general user inputs or to control different states in an application.

Figure A-9. User Switch on the Board

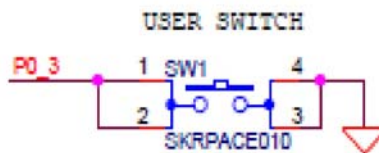

A.2.6.2 Reset Switch

Reset the PSoC target device: When this button is pressed, the XRES line of the PSoC 4100PS is pulled to ground, which, in turn, resets the target device.

Figure A-10. Reset (RST) Switch

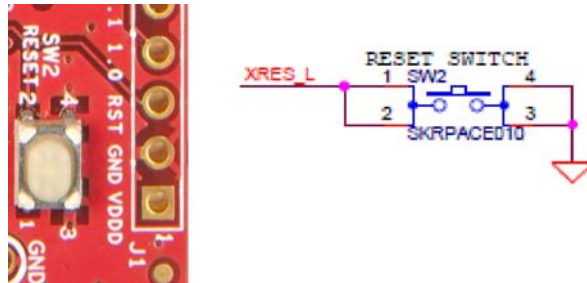

A.2.6.3 Mode Switch

The KitProg2 board contains a push button connected to P1.2 of the PSoC 5LP. When this button is pressed, it toggles between KitProg2 mode and CMSIS-DAP / Mass Storage Mode. Refer to the [KitProg2 User Guide](#) for more details.

Figure A-11. Mode Switch



A.2.6.4 LEDs

The PSoC 4100PS Prototyping kit contains three LEDs:

- The amber Power LED (LED2): Indicates that the board is powered from the PCB USB finger connector. This LED will not glow when the board is powered from VDDD or VTARG directly.
- The amber Status LED (LED3): Indicates the KitProg2 status, connected to **P1[4]** of the KitProg2 PSoC 5LP device. See [Table A-7](#) below for a summary of the status LED states. For more details on the KitProg2 status LED, refer to the [KitProg2 User Guide](#).
- The blue LED (LED1): This is the user LED, connected to **P0[2]** of the target PSoC 4100PS device.

Table A-7. LED status for KitProg2 Modes

KitProg2 Programming Modes *	Status LED (LED3)
KitProg2 Program / Debug Mode (PPCOM mode) (default)	ON
CMSIS-DAP & Mass Storage Programming Mode	OFF

***Note:** Toggling between the Programming modes can be done by pressing SW3 Mode switch.

Figure A-12. Power LED

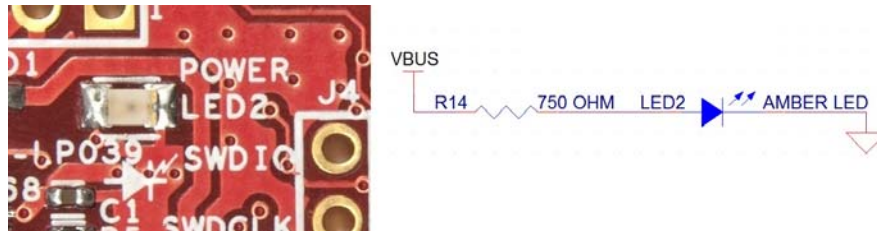

Figure A-13. Status LED

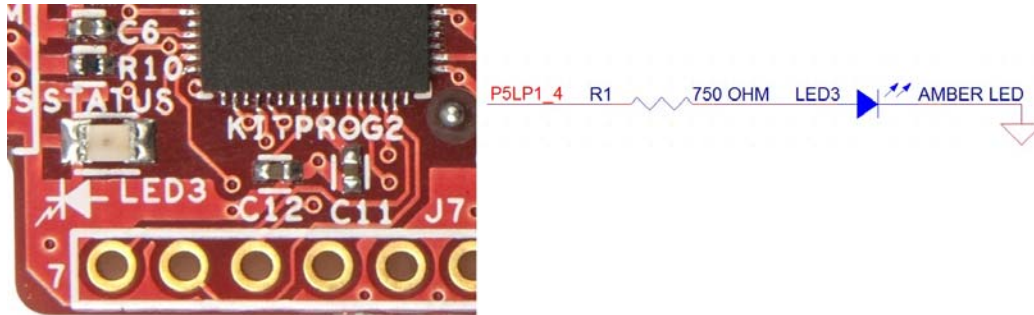
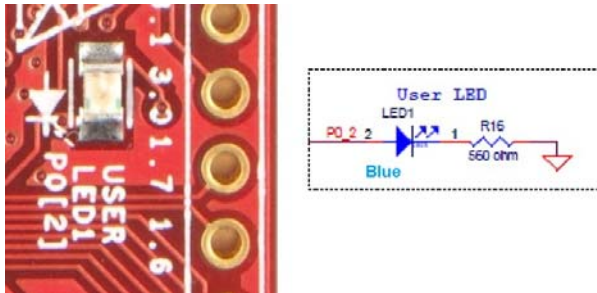

Figure A-14. User LED



A.2.6.5 10-pin Programming Header

PSoC 4100PS can be programmed alternatively through the 10-pin programming header using a MiniProg3 programmer. This can be done by connecting the 10-pin programming header from a MiniProg3 to the 10-pin programming header J9 on the CY8CKIT-147.

Figure A-15. 10-pin Programming Header

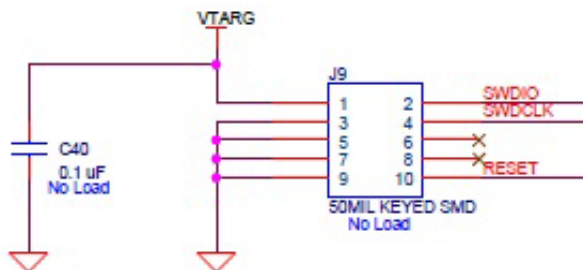

A.3 PSoC 4100PS Prototyping kit Schematics

Refer to the schematic file in the following path in the installed kit software:

```
<Install_Directory>\CY8CKIT-147 PSoC 4100PS Prototyping Kit\  
<version>\Hardware\CY8CKIT-147 Schematic.pdf
```

A.4 Bill of Materials

Refer to the BOM file in the following path in the kit software installed:

```
<Install_Directory>\CY8CKIT-147 PSoC 4100PS Prototyping Kit\  
<version>\Hardware\CY8CKIT-147 PCBA_BOM.xlsm
```

A.5 Programming PSoC 4100PS Prototyping kit Using MiniProg3/ KitProg2

The target board provides a provision to program the PSoC 4100PS device using MiniProg3 or an external KitProg2 via the 10-pin JTAG header or the 5-pin SWD header. To do this, connect wires or a 5-pin 100-mil spaced header to J5 or a 10-pin JTAG header to J9 on the target board. The PSoC 4100PS Prototyping kit supports both power cycle and reset programming modes. The 10-pin header can also be used to connect a third party debugger.

Figure A-16. Connecting the CY8CKIT-147 to a MiniProg3

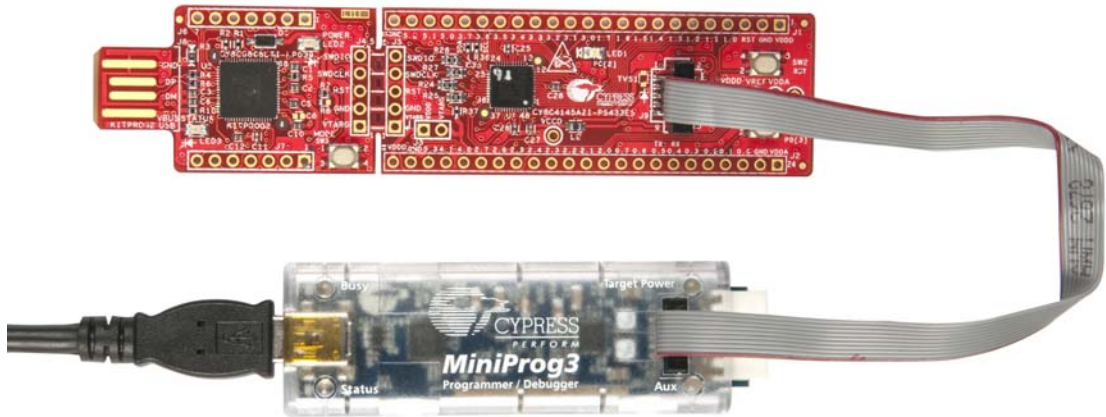

Note: [CY8CKIT-002 MiniProg3](#) is not part of the PSoC 4100PS Prototyping Kit contents and can be purchased from the [Cypress Online Store](#).

Revision History



Document Revision History

Document Title: CY8CKIT-147 PSoC® 4100PS Prototyping Kit Guide				
Document Number: 002-18734				
Revision	ECN#	Issue Date	Origin of Change	Description of Change
**	5630967	03/21/2017	NMIT	New kit guide.
*A	5980583	12/05/2017	NMIT	<p>Updated Introduction chapter on page 7:</p> <p>Updated “Technical Support” on page 12:</p> <p>Replaced “Ext. 2” with “Ext. 3”.</p> <p>Updated Software Installation chapter on page 15:</p> <p>Updated “Install Software” on page 15:</p> <p>Updated description.</p> <p>Updated Kit Operation chapter on page 19:</p> <p>Updated “Theory of Operation” on page 19:</p> <p>Updated Table 3-1.</p> <p>Updated “Programming and Debugging the PSoC 4100PS Target Device” on page 21:</p> <p>Updated “Programming Using PSoC Programmer” on page 23:</p> <p>Updated description.</p> <p>Updated Appendix chapter on page 30:</p> <p>Updated “Hardware Details” on page 32:</p> <p>Updated “Power Supply System” on page 34:</p> <p>Updated description.</p> <p>Updated “User and Passive Inputs” on page 39:</p> <p>Updated “LEDs” on page 40:</p> <p>Updated Table A-7.</p>
*B	6018614	01/08/2018	NMIT	<p>Updated Introduction chapter on page 7:</p> <p>Updated “PSoC Creator” on page 8:</p> <p>Updated “PSoC Creator Code Examples” on page 9:</p> <p>Updated Figure 1-3.</p> <p>Updated Figure 1-4.</p>

Document Revision History (*continued*)

Document Title: CY8CKIT-147 PSoC® 4100PS Prototyping Kit Guide				
Document Number: 002-18734				
Revision	ECN#	Issue Date	Origin of Change	Description of Change
*B (cont.)	6018614	01/08/2018	NMIT	Updated Code Examples chapter on page 25 : Updated "Using the Kit Code Examples" on page 25: Updated Figure 4-1 . Updated Figure 4-4 . Updated Figure 4-5 . Updated "Using Built-in PSoC Creator Code Examples with the Kit" on page 28 : Updated Figure 4-9 . Updated Appendix chapter on page 30 : Updated "Hardware Details" on page 32 : Updated "Power Supply System" on page 34 : Updated "Measure PSoC 4100PS Current Consumption" on page 34 : Updated description. Completing Sunset Review.
*C	6088053	03/08/2018	NMIT	Replaced "CMIS-DAP" with "CMSIS-DAP" in all instances across the document. Updated hyperlinks across the document. Updated Introduction chapter on page 7 : Updated "Kit Contents" on page 7 : Updated Figure 1-1 . Updated "Additional Learning Resources" on page 12 : Updated description. Updated Software Installation chapter on page 15 : Updated "Install Software" on page 15 : Updated description. Updated Figure 2-1 . Added "Installing PSoC 4100PS Device in PSoC Creator" on page 18 .

Document Revision History (*continued*)

Document Title: CY8CKIT-147 PSoC® 4100PS Prototyping Kit Guide				
Document Number: 002-18734				
Revision	ECN#	Issue Date	Origin of Change	Description of Change
*C (cont.)	6088053	03/08/2018	NMIT	Updated Kit Operation chapter on page 19 : Updated "Theory of Operation" on page 19: Updated Figure 3-1 . Updated "Programming and Debugging the PSoC 4100PS Target Device" on page 21: Updated "Debugging Using PSoC Creator" on page 23: Updated description. Updated "Programming Using PSoC Programmer" on page 23: Updated description. Updated "USB-UART Bridge" on page 23: Updated Figure 3-5 . Updated Appendix chapter on page 30 : Updated "Hardware Details" on page 32: Updated "Power Supply System" on page 34: Updated "Measure PSoC 4100PS Current Consumption" on page 34: Updated description. Updated "Header Connections" on page 35: Updated "Functionality of J4 and J5 Headers (PSoC 4100PS to KitProg2)" on page 37: Updated Table A-3 . Updated Table A-4 . Updated "Functionality of J6 and J7 Headers (KitProg2)" on page 38: Updated Table A-6 . Updated "User and Passive Inputs" on page 39: Updated "LEDs" on page 40: Updated description. Updated to new template.
*D	6281376	08/14/2018	DIMA	Updated Kit Operation chapter on page 19 : Updated "Theory of Operation" on page 19: Updated description.