

IRF1503PbF

Typical Applications

- Industrial Motor Drive

Features

- Advanced Process Technology
- Ultra Low On-Resistance
- 175°C Operating Temperature
- Fast Switching
- Repetitive Avalanche Allowed up to Tjmax

Description

This design of HEXFET® Power MOSFETs utilizes the latest processing techniques to achieve extremely low on-resistance per silicon area. Additional features of this HEXFET power MOSFET are a 175°C junction operating temperature, fast switching speed and improved repetitive avalanche rating. These combine to make this design an extremely efficient and reliable device for use in a wide variety of applications.

HEXFET® Power MOSFET

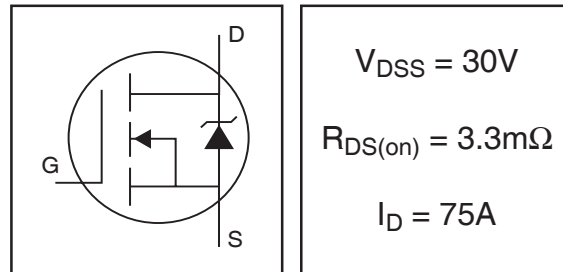

Absolute Maximum Ratings

	Parameter	Max.	Units
$I_D @ T_C = 25^\circ C$	Continuous Drain Current, $V_{GS} @ 10V$ (Silicon limited)	240	A
$I_D @ T_C = 100^\circ C$	Continuous Drain Current, $V_{GS} @ 10V$ (See Fig.9)	170	
$I_D @ T_C = 25^\circ C$	Continuous Drain Current, $V_{GS} @ 10V$ (Package limited)	75	
I_{DM}	Pulsed Drain Current ①	960	
$P_D @ T_C = 25^\circ C$	Power Dissipation	330	W
	Linear Derating Factor	2.2	W/°C
V_{GS}	Gate-to-Source Voltage	± 20	V
E_{AS}	Single Pulse Avalanche Energy②	510	mJ
E_{AS} (tested)	Single Pulse Avalanche Energy Tested Value⑥	980	
I_{AR}	Avalanche Current①	See Fig.12a, 12b, 15, 16	A
E_{AR}	Repetitive Avalanche Energy⑤		mJ
T_J	Operating Junction and	-55 to + 175	°C
T_{STG}	Storage Temperature Range		
	Soldering Temperature, for 10 seconds	300 (1.6mm from case)	

Thermal Resistance

	Parameter	Typ.	Max.	Units
$R_{\theta JC}$	Junction-to-Case	—	0.45	°C/W
$R_{\theta CS}$	Case-to-Sink, Flat, Greased Surface	0.50	—	
$R_{\theta JA}$	Junction-to-Ambient	—	62	

Electrical Characteristics @ $T_J = 25^\circ\text{C}$ (unless otherwise specified)

	Parameter	Min.	Typ.	Max.	Units	Conditions
$V_{(BR)DSS}$	Drain-to-Source Breakdown Voltage	30	—	—	V	$V_{GS} = 0V, I_D = 250\mu A$
$\Delta V_{(BR)DSS}/\Delta T_J$	Breakdown Voltage Temp. Coefficient	—	0.028	—	$V/^\circ\text{C}$	Reference to $25^\circ\text{C}, I_D = 1\text{mA}$
$R_{DS(on)}$	Static Drain-to-Source On-Resistance	—	2.6	3.3	$\text{m}\Omega$	$V_{GS} = 10V, I_D = 140A$ ③
$V_{GS(th)}$	Gate Threshold Voltage	2.0	—	4.0	V	$V_{DS} = 10V, I_D = 250\mu A$
g_{fs}	Forward Transconductance	75	—	—	S	$V_{DS} = 25V, I_D = 140A$
I_{DSS}	Drain-to-Source Leakage Current	—	—	20	μA	$V_{DS} = 30V, V_{GS} = 0V$
		—	—	250		$V_{DS} = 30V, V_{GS} = 0V, T_J = 125^\circ\text{C}$
I_{GSS}	Gate-to-Source Forward Leakage	—	—	200	nA	$V_{GS} = 20V$
	Gate-to-Source Reverse Leakage	—	—	-200		$V_{GS} = -20V$
Q_g	Total Gate Charge	—	130	200	nC	$I_D = 140A$
Q_{gs}	Gate-to-Source Charge	—	36	54		$V_{DS} = 24V$
Q_{gd}	Gate-to-Drain ("Miller") Charge	—	41	62		$V_{GS} = 10V$
$t_{d(on)}$	Turn-On Delay Time	—	17	—	ns	$V_{DD} = 15V$
t_r	Rise Time	—	130	—		$I_D = 140A$
$t_{d(off)}$	Turn-Off Delay Time	—	59	—		$R_G = 2.5\Omega$
t_f	Fall Time	—	48	—		$V_{GS} = 10V$ ③
L_D	Internal Drain Inductance	—	5.0	—	nH	Between lead, 6mm (0.25in.) from package and center of die contact
L_S	Internal Source Inductance	—	13	—		
C_{iss}	Input Capacitance	—	5730	—	pF	$V_{GS} = 0V$
C_{oss}	Output Capacitance	—	2250	—		$V_{DS} = 25V$
C_{rss}	Reverse Transfer Capacitance	—	290	—		$f = 1.0\text{MHz}$, See Fig. 5
C_{oss}	Output Capacitance	—	7580	—		$V_{GS} = 0V, V_{DS} = 1.0V, f = 1.0\text{MHz}$
C_{oss}	Output Capacitance	—	2290	—		$V_{GS} = 0V, V_{DS} = 24V, f = 1.0\text{MHz}$
$C_{oss \text{ eff.}}$	Effective Output Capacitance ④	—	3420	—		$V_{GS} = 0V, V_{DS} = 0V \text{ to } 24V$

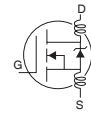

Source-Drain Ratings and Characteristics

	Parameter	Min.	Typ.	Max.	Units	Conditions
I_S	Continuous Source Current (Body Diode)	—	—	240	A	MOSFET symbol showing the integral reverse p-n junction diode.
I_{SM}	Pulsed Source Current (Body Diode) ①	—	—	960		
V_{SD}	Diode Forward Voltage	—	—	1.3	V	$T_J = 25^\circ\text{C}, I_S = 140A, V_{GS} = 0V$ ③
t_{rr}	Reverse Recovery Time	—	71	110	ns	$T_J = 25^\circ\text{C}, I_F = 140A, V_{DD} = 15V$
Q_{rr}	Reverse Recovery Charge	—	110	170	nC	$di/dt = 100A/\mu s$ ③
t_{on}	Forward Turn-On Time	Intrinsic turn-on time is negligible (turn-on is dominated by $L_S + L_D$)				

Notes:

- ① Repetitive rating; pulse width limited by max. junction temperature. (See fig. 11).
- ② Starting $T_J = 25^\circ\text{C}$, $L = 0.049\text{mH}$, $R_G = 25\Omega$, $I_{AS} = 140A$. (See Figure 12).
- ③ Pulse width $\leq 400\mu s$; duty cycle $\leq 2\%$.

- ④ $C_{oss \text{ eff.}}$ is a fixed capacitance that gives the same charging time as C_{oss} while V_{DS} is rising from 0 to 80% V_{DSS} .
- ⑤ Limited by T_{Jmax} , see Fig.12a, 12b, 15, 16 for typical repetitive avalanche performance.
- ⑥ This value determined from sample failure population. 100% tested to this value in production.

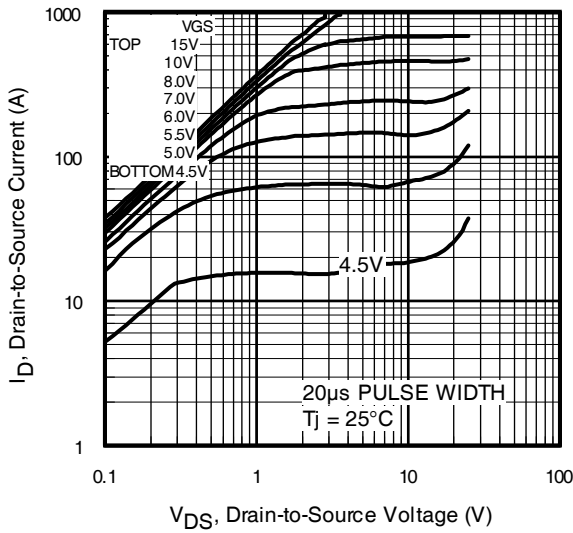

Fig 1. Typical Output Characteristics

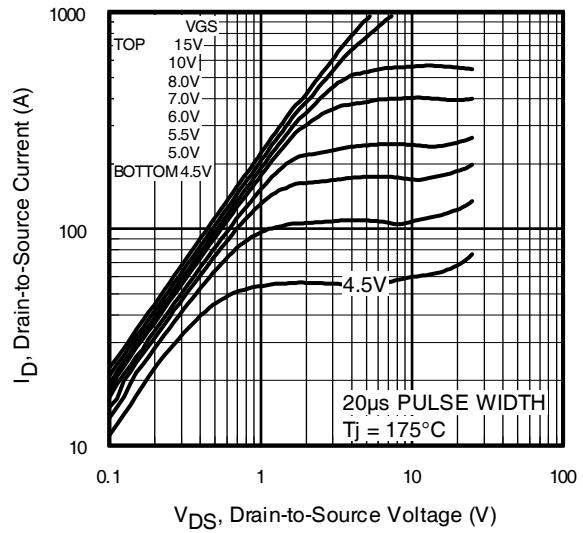

Fig 2. Typical Output Characteristics

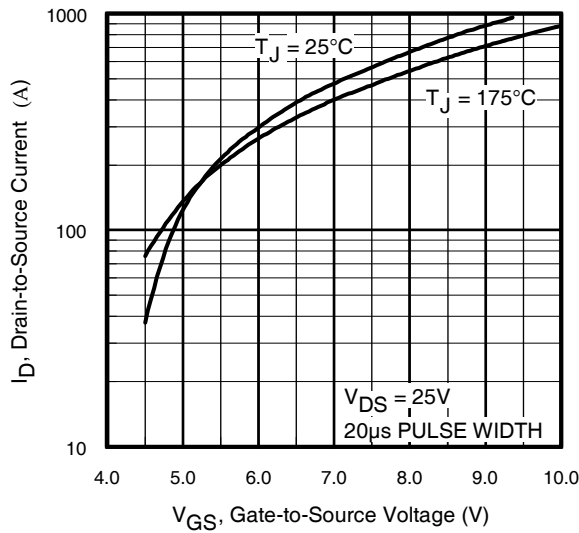

Fig 3. Typical Transfer Characteristics

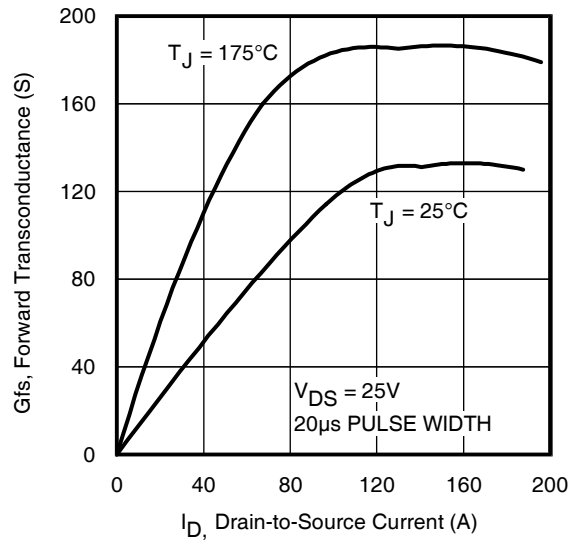

Fig 4. Typical Forward Transconductance Vs. Drain Current

IRF1503PbF

International
IR Rectifier

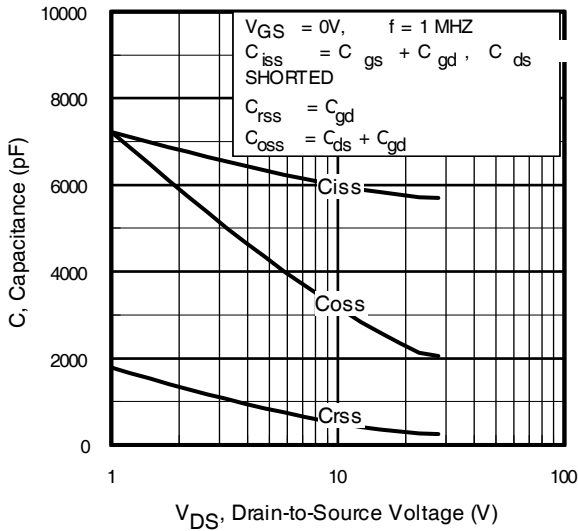

Fig 5. Typical Capacitance Vs. Drain-to-Source Voltage

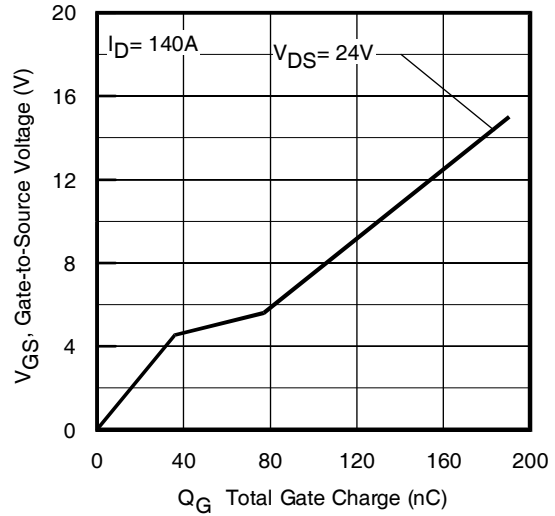

Fig 6. Typical Gate Charge Vs. Gate-to-Source Voltage

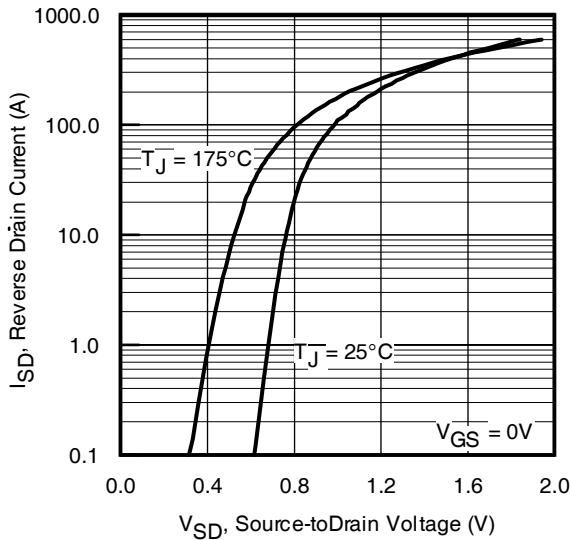

Fig 7. Typical Source-Drain Diode Forward Voltage

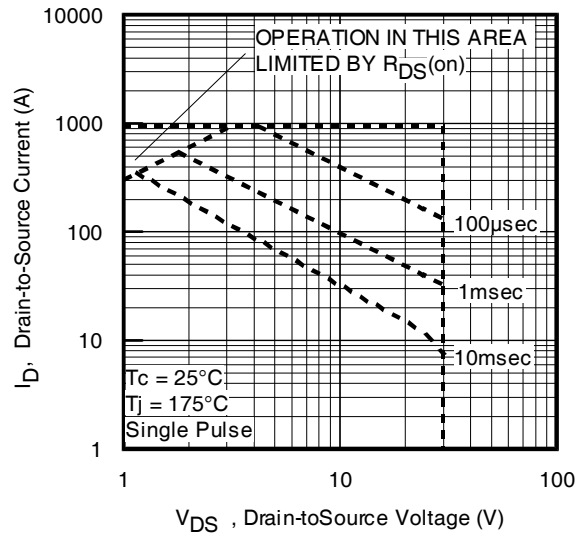

Fig 8. Maximum Safe Operating Area

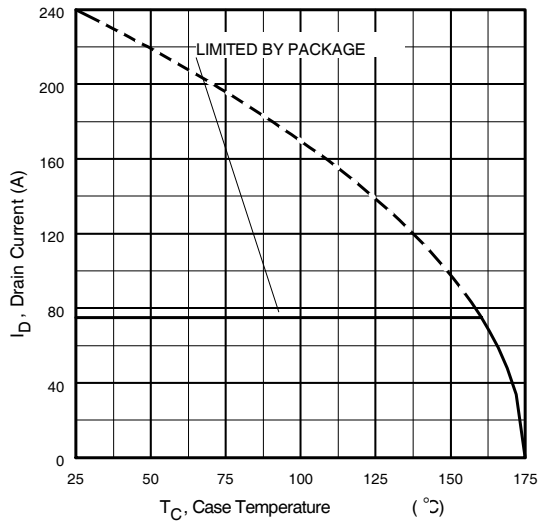

Fig 9. Maximum Drain Current Vs. Case Temperature

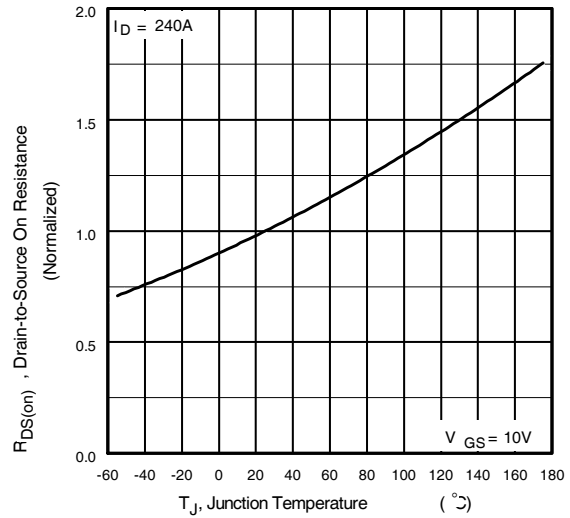

Fig 10. Normalized On-Resistance Vs. Temperature

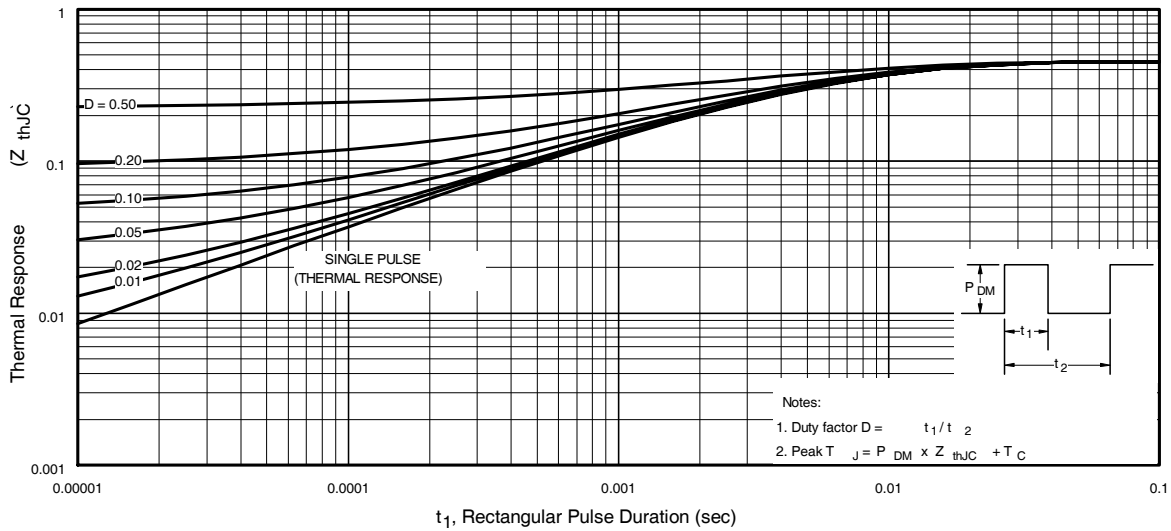

Fig 11. Maximum Effective Transient Thermal Impedance, Junction-to-Case

IRF1503PbF

International
IR Rectifier

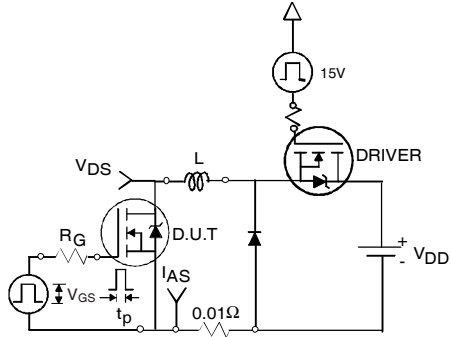

Fig 12a. Unclamped Inductive Test Circuit



Fig 12b. Unclamped Inductive Waveforms

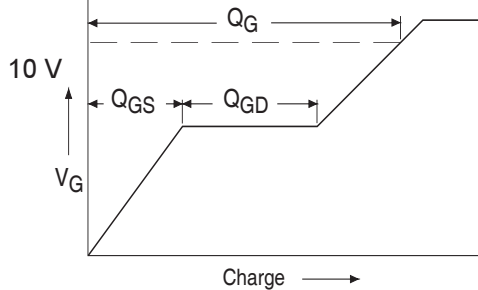

Fig 13a. Basic Gate Charge Waveform

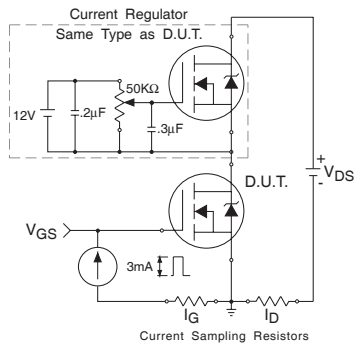

Fig 13b. Gate Charge Test Circuit

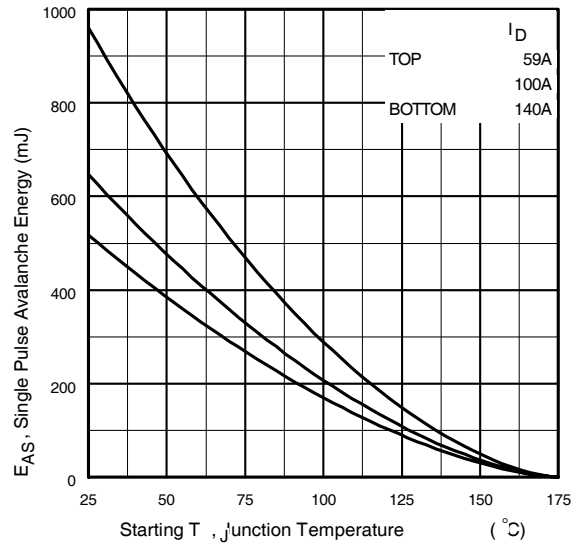

Fig 12c. Maximum Avalanche Energy Vs. Drain Current

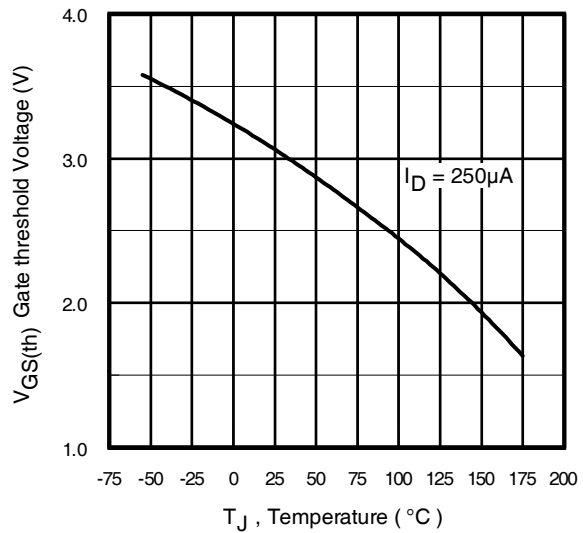

Fig 14. Threshold Voltage Vs. Temperature

www.irf.com

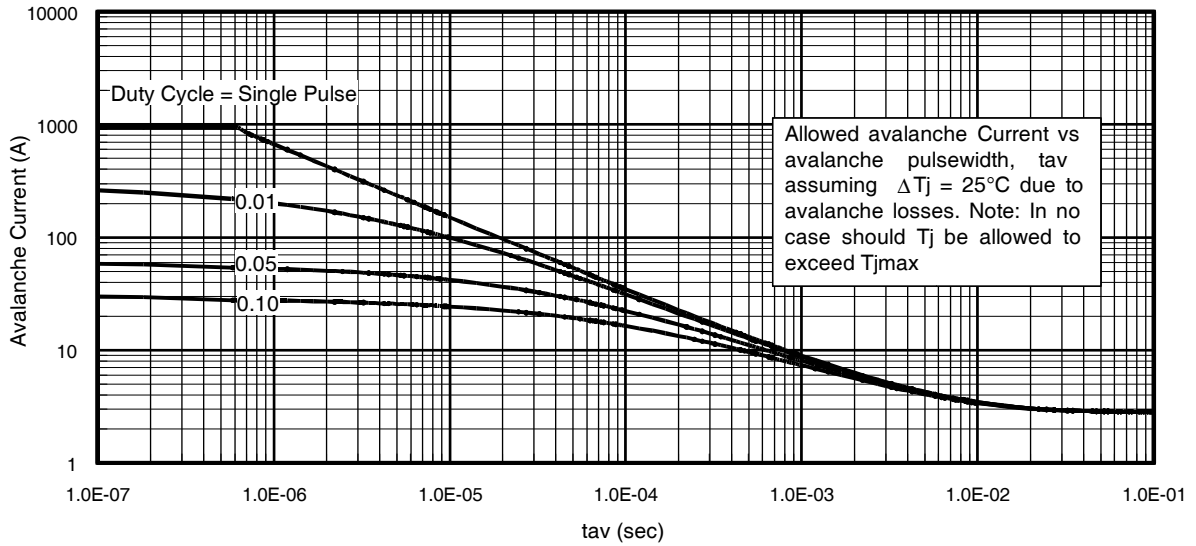

Fig 15. Typical Avalanche Current Vs.Pulsewidth

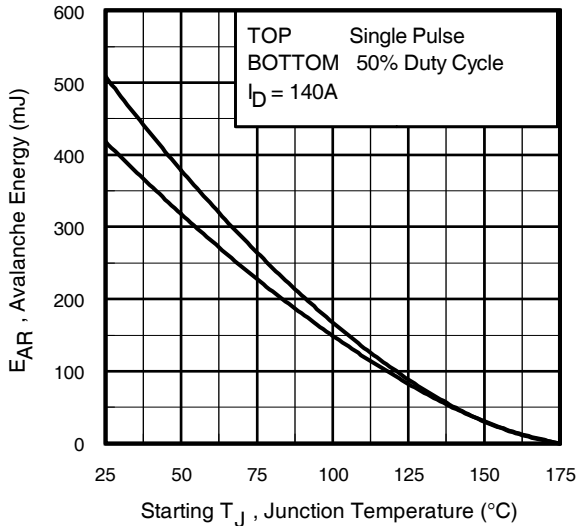

Fig 16. Maximum Avalanche Energy Vs. Temperature

**Notes on Repetitive Avalanche Curves , Figures 15, 16:
(For further info, see AN-1005 at www.irf.com)**

1. Avalanche failures assumption:
Purely a thermal phenomenon and failure occurs at a temperature far in excess of T_{jmax} . This is validated for every part type.
2. Safe operation in Avalanche is allowed as long as T_{jmax} is not exceeded.
3. Equation below based on circuit and waveforms shown in Figures 12a, 12b.
4. $P_{D(ave)}$ = Average power dissipation per single avalanche pulse.
5. BV = Rated breakdown voltage (1.3 factor accounts for voltage increase during avalanche).
6. I_{av} = Allowable avalanche current.
7. ΔT = Allowable rise in junction temperature, not to exceed T_{jmax} (assumed as 25°C in Figure 15, 16).
 t_{av} = Average time in avalanche.
D = Duty cycle in avalanche = $t_{av} \cdot f$
 $Z_{thJC}(D, t_{av})$ = Transient thermal resistance, see figure 11)

$$P_{D(ave)} = 1/2 (1.3 \cdot BV \cdot I_{av}) = \Delta T / Z_{thJC}$$

$$I_{av} = 2\Delta T / [1.3 \cdot BV \cdot Z_{th}]$$

$$E_{AS(AR)} = P_{D(ave)} \cdot t_{av}$$

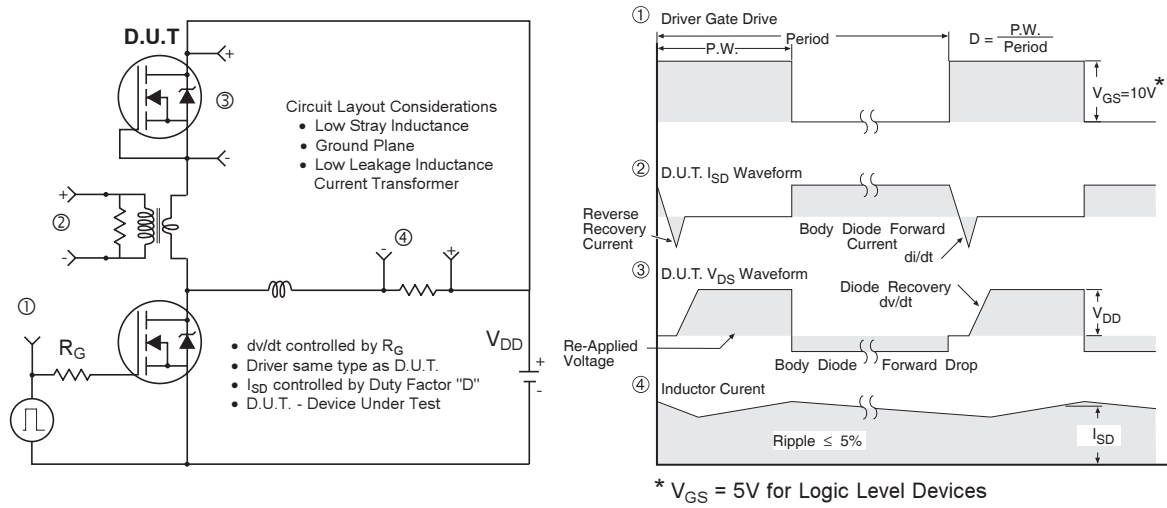

Fig 17. Peak Diode Recovery dv/dt Test Circuit for N-Channel HEXFET® Power MOSFETs

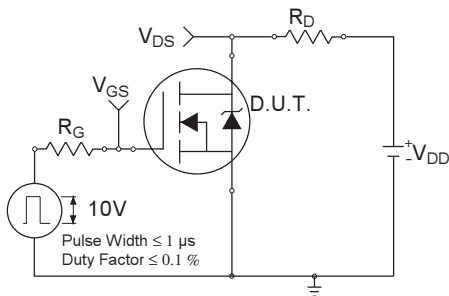

Fig 18a. Switching Time Test Circuit

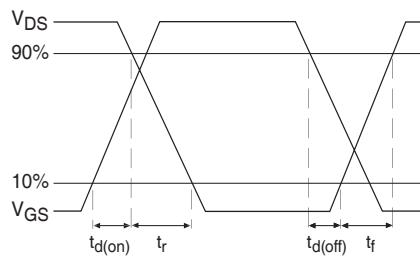
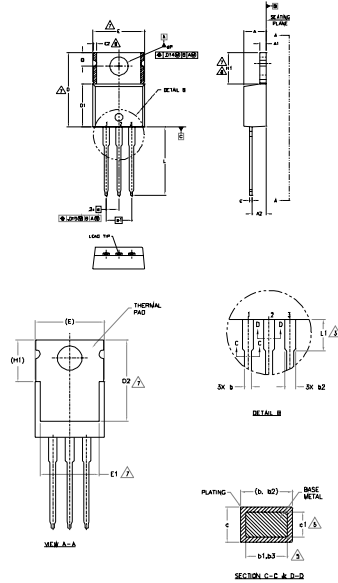

Fig 18b. Switching Time Waveforms

TO-220AB Package Outline

Dimensions are shown in millimeters (inches)



- NOTES
1. DIMENSIONS AND TOLERANCES AS PER ASSE 1745 M- 1994
 2. DIMENSIONS ARE SHOWN IN INCHES (MILLIMETERS)
 3. LEAD DIMENSION AND FINISH UNCONTROLLED IN LT
 4. DIMENSION D1, D2 & L1 DO NOT INCLUDE MOLD FLASH. MOLD FLASH SHALL NOT EXCEED .007" (0.177) PER SIDE. THESE DIMENSIONS ARE MEASURED AT THE OUTERMOST EDGES OF THE PLASTIC BODY.
 5. DIMENSION D1, D2 & L1 APPLY TO BASE METAL ONLY
 6. CONTROLLING DIMENSION - INCHES
 7. THERMAL PAD CONTOUR OPTIONAL. WITHIN DIMENSIONS E, H1, D2 & E1
 8. DIMENSION E2 > H1 DEFINE A ZONE WHERE STAMPING AND SOLDERATION DISCREPANCIES ARE ALLOWED
 9. OUTLINE CONFORMS TO JEDEC TO-220, EXCEPT A2 (max.) AND D2 (min.) WHERE DIMENSIONS ARE DERIVED FROM THE ACTUAL PACKAGE OUTLINE.

SYMBOL	DIMENSIONS				NOTES
	MILLIMETERS		INCHES		
	MIN.	MAX.	MIN.	MAX.	
A	5.56	4.83	.140	.191	
A1	0.51	1.40	.020	.055	
A2	2.03	2.92	.080	.115	
B	0.38	1.01	.015	.040	
b1	0.30	0.97	.015	0.08	5
b2	1.14	1.78	.045	0.070	5
b3	1.14	1.73	.045	.066	
c	0.36	0.61	.014	.024	
c1	0.36	0.56	.014	.022	5
D	14.22	16.51	.560	.650	4
D1	9.39	9.02	.330	.355	
D2	11.68	12.88	.460	.507	7
E	9.85	10.67	.380	.420	4,7
E1	6.86	6.89	.270	.269	7
E2	-	0.76	-	.030	8
e	2.03	2.03	.080	.080	
e1	2.03	2.03	.080	.080	
H1	5.84	6.86	.230	.270	7,8
L	12.70	14.73	.500	.580	
L1	1.56	4.08	.140	.160	3
ØP	3.54	4.08	.139	.161	
Ø	2.54	3.42	.100	.135	

- LEAD ASSIGNMENTS
- MARKING
1. CASE
 2. SYMBOL
 3. PART NO.
- DATE CODE
1. YEAR
 2. WEEK
 3. LINE

TO-220AB Part Marking Information

EXAMPLE: THIS IS AN IRF1010
LOT CODE 1789
ASSEMBLED ON WW 19, 2000
IN THE ASSEMBLY LINE "C"

Note: "P" in assembly line position indicates "Lead - Free"

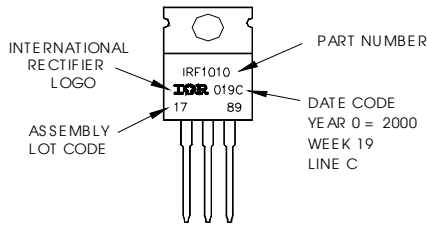

TO-220AB package is not recommended for Surface Mount Application.

Notes:

1. For an Automotive Qualified version of this part please see <http://www.irf.com/product-info/auto/>
2. For the most current drawing please refer to IR website at <http://www.irf.com/package/>

Data and specifications subject to change without notice.
This product has been designed and qualified for Industrial market.
Qualification Standards can be found on IR's Web site.