

MIO-5271

**Intel® Core™ U-series (i5/Celeron®),
3.5" MI/O-Compact SBC, DDR3L,
VGA, HDMI/DP, 48-bit LVDS, 2 x GbE,
2 x Mini PCIe, mSATA, Fanless,
MIOe, iManager, SUSIAccess**

Copyright

The documentation and the software included with this product are copyrighted 2014 by Advantech Co., Ltd. All rights are reserved. Advantech Co., Ltd. reserves the right to make improvements in the products described in this manual at any time without notice. No part of this manual may be reproduced, copied, translated or transmitted in any form or by any means without the prior written permission of Advantech Co., Ltd. Information provided in this manual is intended to be accurate and reliable. However, Advantech Co., Ltd. assumes no responsibility for its use, nor for any infringements of the rights of third parties, which may result from its use.

Acknowledgements

Intel® is a trademark of Intel® Corporation.

AMI is a trademark of American Megatrends, Inc.

IBM, PC, PS/2 and VGA are trademarks of International Business Machines Corporation.

Microsoft Windows®, DirectX® is a registered trademark of Microsoft Corp.

All other product names or trademarks are properties of their respective owners.

For more information on this and other Advantech products, please visit our websites at:

<http://www.advantech.com>

<http://www.advantech.com/eplatform>

For technical support and service, please visit our support website at:

<http://support.advantech.com/>

This manual is for the MIO-5271.

Product Warranty (2 years)

Advantech warrants to you, the original purchaser, that each of its products will be free from defects in materials and workmanship for two years from the date of purchase.

This warranty does not apply to any products which have been repaired or altered by persons other than repair personnel authorized by Advantech, or which have been subject to misuse, abuse, accident or improper installation. Advantech assumes no liability under the terms of this warranty as a consequence of such events.

Because of Advantech's high quality-control standards and rigorous testing, most of our customers never need to use our repair service. If an Advantech product is defective, it will be repaired or replaced at no charge during the warranty period. For out-of-warranty repairs, you will be billed according to the cost of replacement materials, service time and freight. Please consult your dealer for more details.

If you think you have a defective product, follow these steps:

1. Collect all the information about the problem encountered. (For example, CPU speed, Advantech products used, other hardware and software used, etc.) Note anything abnormal and list any onscreen messages you get when the problem occurs.
2. Call your dealer and describe the problem. Please have your manual, product, and any helpful information readily available.
3. If your product is diagnosed as defective, obtain an RMA (return merchandise authorization) number from your dealer. This allows us to process your return more quickly.
4. Carefully pack the defective product, a fully-completed Repair and Replacement Order Card and a photocopy proof of purchase date (such as your sales receipt) in a shippable container. A product returned without proof of the purchase date is not eligible for warranty service.
5. Write the RMA number visibly on the outside of the package and ship it prepaid to your dealer.

Declaration of Conformity

CE

This product has passed the CE test for environmental specifications. Test conditions for passing included the equipment being operated within an industrial enclosure. In order to protect the product from being damaged by ESD (Electrostatic Discharge) and EMI leakage, we strongly recommend the use of CE-compliant industrial enclosure products.

FCC Class A

This equipment has been tested and found to comply with the limits for a Class A digital device, pursuant to part 15 of the FCC Rules. These limits are designed to provide reasonable protection against harmful interference when the equipment is operated in a commercial environment. This equipment generates, uses, and can radiate radio frequency energy and, if not installed and used in accordance with the instruction manual, may cause harmful interference to radio communications. Operation of this equipment in a residential area is likely to cause harmful interference in which case the user will be required to correct the interference at his own expense.

Caution!



There is a danger of a new battery exploding if it is incorrectly installed. Do not attempt to recharge, force open, or heat the battery. Replace the battery only with the same or equivalent type recommended by the manufacturer. Discard used batteries according to the manufacturer's instructions.

Technical Support and Assistance

1. Visit the Advantech website at <http://support.advantech.com> where you can find the latest information about the product.
2. Contact your distributor, sales representative, or Advantech's customer service center for technical support if you need additional assistance. Please have the following information ready before you call:
 - Product name and serial number
 - Description of your peripheral attachments
 - Description of your software (operating system, version, application software, etc.)
 - A complete description of the problem
 - The exact wording of any error messages

Packing List

Before you begin installing your card, please make sure that the following materials have been shipped:

- 1 x MIO-5271 SBC
- 1 x SATA Cable 30cm (p/n: 1700006291)
- 1 x SATA Power Cable 35cm (p/n: 1700018785)
- 1 x Audio Cable 20cm (p/n: 1700019584)
- 2 x COM RS-232 Cable 22cm (p/n: 1701200220)
- 1 x Heatsink (24mm) (p/n: 1960057432N001)
- 1 x Startup manual (p/n: 2006527100)
- 1 x Mini Jumper(10pcs package) (p/n: 9689000002)
- 1 x Screw Kit (3pcs screws for miniPCIe) (p/n: 9666529000E)
- 1 x SUSIAccess Pro package (p/n: 968EMLSAP1)

If any of these items are missing or damaged, contact your distributor or sales representative immediately.

Optional MIOe Module

Part Number	Description
MIOe-210-D6A1E	4 x RS232/422/485 2x RS422/485 with DSUB connector, 8-bit GPIO
MIOe-220-B3A1E	3 x Intel® Gigabit Ethernet with PCIe Switch
MIOe-230-L0A1E	Displayport to 48-bit LVDS
MIOe-DB5000-01A1E	MI/O extension evaluation board
MIOe-3672-AE	2-port PoE ports MIOe Module
MIOe-3680-AE	2-Port CAN-Bus MIOe Module with Isolation Protection

Optional Accessories

Part number	Description
1960063980N001	Heat spreader 137x84.2x16.7-mm MIO-5271
1935032000	Screw of Heatsink / Cooler R/S 5.5 2.0 +M M3*20L ST Ni
1930000058	The POST Stand off, F=M3*8L M=M3*4L D=5 H=19L Cu

Contents

Chapter 1	General Information	1
1.1	Introduction	2
1.2	Specifications	2
1.2.1	Functional Specifications	2
1.2.2	OS support.....	4
1.2.3	Mechanical Specifications.....	4
1.2.4	Electrical Specifications	4
1.2.5	Environmental	5
1.3	Block Diagram.....	6
1.4	Board layout: dimensions.....	7
	Figure 1.1 MIO-5271 Mechanical Drawing (Top Side)	7
	Figure 1.2 MIO-5271 Mechanical Drawing (Bottom Side)	7
	Figure 1.3 MIO-5271 Mechanical Drawing (Coastline).....	8
Chapter 2	Installation.....	9
2.1	Jumpers & Switches.....	10
	Table 2.1: Jumpers & Switches	10
2.2	Connectors.....	10
	Table 2.2: Connectors	10
2.3	Locating connectors & block diagram	11
	Figure 2.1 MIO-5271 Connector Locations (Top Side).....	11
	Figure 2.2 MIO-5271 Connector Locations (Bottom Side).....	11
	Figure 2.3 MIO-5271 Connector Locations (Coastline)	11
2.4	Setting Jumpers	12
2.4.1	Auto Power On Setting (J2)	12
	Table 2.3: Auto Power On Setting (J2).....	12
2.4.2	LCD Power (J3)	12
	Table 2.4: LCD Power (J3).....	12
2.4.3	PCIe & mSATA Selection (SW2)	13
	Table 2.5: mPCIe & mSATA Selection (SW2).....	13
2.4.4	Clear CMOS (SW3)	13
	Table 2.6: Clear CMOS (SW3).....	13
Chapter 3	AMI BIOS Setup	15
	Figure 3.1 Setup program initial screen.....	16
3.1	Entering Setup	17
3.2	Main Setup	17
	Figure 3.2 Main setup screen	17
3.2.1	System time / System date	17
3.3	Advanced BIOS Features Setup	18
	Figure 3.3 Advanced BIOS features setup screen	18
3.3.1	PCI Subsystem Settings	19
	Figure 3.4 PCI Subsystem Settings.....	19
3.3.2	PCI Express Device Register Settings.....	20
	Figure 3.5 PCI Express Device Register Settings	20
3.3.3	ACPI Settings.....	21
	Figure 3.6 ACPI Setting	21
3.3.4	Trusted Computing	22
	Figure 3.7 Trusted Computing Configuration.....	22
3.3.5	S5 RTC Wake Settings	23
	Figure 3.8 S5 RTC Wake Settings.....	23

3.3.6	CPU Configuration.....	24
	Figure 3.9 CPU Configuration Setting	24
3.3.7	SATA Configuration	25
	Figure 3.10SATA Configuration.....	25
3.3.8	AMT Configuration.....	26
	Figure 3.11AMT Configuration	26
3.3.9	PCH-FW Configuration	27
	Figure 3.12PCH-FW Configuration.....	27
3.3.10	Intel® Rapid Start Technology.....	28
	Figure 3.13Intel® Rapid Technology	28
3.3.11	USB Configuration	29
	Figure 3.14USB Configuration.....	29
3.3.12	Embedded Controller Configuration	30
	Figure 3.15Embedded Controller Configuration	30
3.3.13	Super IO Configuration	31
	Figure 3.16Super IO Configuration.....	31
3.3.14	Serial Port Console Redirection.....	32
	Figure 3.17Serial Port Console Redirection	32
3.4	Chipset.....	33
	Figure 3.18Chipset Setup.....	33
3.4.1	System Agent (SA) Configuration.....	34
	Figure 3.19System Agent (SA) Configuration	34
	Figure 3.20Intel IGFX Configuration.....	34
	Figure 3.21LCD Control.....	35
	Figure 3.22Memory Configuration	36
3.4.2	PCH-IO Configuration.....	37
	Figure 3.23PCH-IO Configuration	37
	Figure 3.24PCI Express Configuration	38
	Figure 3.25USB Configuration.....	39
	Figure 3.26PCH Azalia Configuration.....	40
3.5	Boot Settings.....	41
	Figure 3.27Boot Setup Utility.....	41
3.6	Security Setup.....	42
	Figure 3.28Password Configuration	42
3.7	Save & Exit	43
	Figure 3.29Save & Exit.....	43
3.7.1	Save Changes and Exit.....	43
3.7.2	Discard Changes and Exit.....	43
3.7.3	Discard Changes and Reset.....	43
3.7.4	Save Changes	43
3.7.5	Discard Changes	43
3.7.6	Restore Defaults.....	44
3.7.7	Save as User Defaults	44
3.7.8	Restore User Defaults	44
3.7.9	Boot Override.....	44

Chapter 4 MIOe Installation 45

4.1	Quick Installation Guide:.....	46
-----	--------------------------------	----

Appendix A Pin Assignments 47

A.1	Jumper and Connector Tables.....	48
-----	----------------------------------	----

Appendix B System Assignments..... 69

B.1	System I/O Ports.....	70
	Table B.1: System I/O Ports	70

B.2	DMA Channel assignments.....	70
	Table B.2: DMA Channel assignments	70
B.3	1st MB memory map	70
	Table B.3: 1st MB memory map	70
B.4	Interrupt assignments.....	71
	Table B.4: Interrupt assignments.....	71

Appendix C Watchdog Timer Sample Code.....73

C.1	Watchdog Timer Sample Code	74
-----	----------------------------------	----

Chapter 1

General Information

This chapter gives background information on the MIO-5271.

Sections include:

- Introduction
- Specifications
- Block diagram
- Board layout and dimensions

1.1 Introduction

MIO-5271 is designed using MI/O Extension form factor (compact series, 146 x 102 mm) and powered by the latest generation of Intel® Core™ U series processors which have low power features but also high performance computing and multimedia capabilities. Based on numerous demands from embedded applications, Advantech developed an optimized thermal solution for MIO-5271. This makes the possibility of fanless design on this kind of high performance platform. MIO-5271 also embeds iManager and SUSIAccess created by Advantech to monitor and control system operation effectively and remotely. These tools offer greater system reliability and a smarter software framework for embedded customers and helps them speed up development times.

MIO-5271 adopts the latest 64-bit, multi-core processors built on 22nm process technology for improvements in CPU processing, graphics, security and I/O flexibility. Upgrading to Intel® AVX 2.0, brings a big enhancement on integer/matrix-based calculations, with Intel® AES-NI allowing security algorithms which speed up hardware accelerated data encryption and decryption.

MIO-5271 is equipped with the latest generation graphics core (Intel® HD Graphics 4400) with DXVA (full AVC/VC1/MPEG2 Hardware Acceleration), OpenGL 4.0 and DirectX 11 which increases more possibilities for multimedia application development. MIO-5271 supports various display interface including HDMI and DisplayPort, legacy VGA interface, 48-bit LVDS and next generation embedded interface: eDP. Triple independent displays including 48-bit LVDS, VGA, and HDMI/DP¹ are also available for creative applications.

1.2 Specifications

1.2.1 Functional Specifications

- **Processor:** 4th Generation Intel® Core™ Processor based on Mobile U-Processor and Mobile Intel® Celeron® processor
 - i5 4300U 1.9 GHz / Dual-Cores, Four-Threads
 - Celeron 2980U 1.6 GHz, Dual Cores, Four Threads
 - Cache Hierarchy
 - * A 64-KB instruction and 64-KB data first-level cache (L1) for each core
 - * A 512-KB shared instruction/data second-level cache (L2) for each core
 - * 3MB / 2 MB Intel® Smart Cache for i5 / Celeron series, shared among all cores
 - Advanced Technologies
 - * Intel® Turbo Boost Technology 2.0² (i5 series only)
 - * Intel® Advanced Vector Extensions 2.0 (Intel® AVX2)
 - * Intel® Hyper-Threading Technology 2-threads per core
 - * Intel® Active Management Technology 9.5 (Intel® AMT 9.5, i5 series only)
 - * Intel® Trusted Execution Technology (Intel® TXT)
 - * Intel® 64 Architecture
 - * Thermal Monitoring Technologies
 - * Enhanced Intel SpeedStep® Technology
- **I/O interface of Platform Controller Hub**
 - Integrated Serial ATA Host Controller
 - * Data transfer rates up to 6.0 Gb/s (600 MB/s)
 - * Integrated AHCI controller
 - USB
 - * xHCI Host Controller, supporting 2 SuperSpeed USB 3.0 ports
 - * One EHCI Host Controllers, supporting 2 HighSpeed USB 2.0 ports

- * Supports wake-up from sleeping states S1, S3
- * Supports legacy Keyboard/Mouse software
- Power Management Logic
 - * Supports Intel Power Optimizer
 - * Supports ACPI 4.0a
 - * ACPI-defined power states (processor driven C states)
 - * ACPI Power Management Timer
 - * SMI# generation
- **System Memory Support**
 - Non-ECC, DDR3L/DDR3L-RS and LPDDR3 memory with Unbuffered SO-DIMM up to 8GB
 - DDR3L/DDR3L-RS I/O Voltage of 1.35V
 - * 1333 MT/s (PC3-10600), 1600 MT/s (PC3-12800)
 - 64-bit wide channels
 - Intel® Fast Memory Access (Intel® FMA):
 - * Just-in-Time Command Scheduling
 - * Command Overlap
 - * Out-of-Order Scheduling
- **Integrated Graphics Controller**
 - Contains a generation 7.5 graphics core architecture (Intel® HD Graphics 4400), with 200MHz Graphics Base Frequency and 1.1GHz Graphics Max Dynamic Frequency²
 - Next Generation Intel Clear Video Technology HD Support
 - * Playback of Blu-ray* disc S3D content using HDMI (1.4a specification compliant with 3D)
 - DirectX* Video Acceleration (DXVA) support for accelerating video processing
 - * Full AVC/VC1/MPEG2 Hardware Decode
 - OpenGL4.0 support
 - DirectX 11.1, DirectX 11, DirectX 10.1, DirectX 10, DirectX 9 support
 - Multi-display interfaces: VGA, HDMI/DisplayPort¹ on rear I/O, Dual Channel 24-bit LVDS, DisplayPort¹ from MIOe
 - Support Extend, Clone and Collage mode with multi-display device
 - Dual Display:
 - * Any two combination between: VGA, LVDS, HDMI, DisplayPort¹ (from Rear I/O line), DisplayPort¹ (from MIOe)
 - Triple Display:
 - * VGA+HDMI/DisplayPort¹+ LVDS
 - Integrated Dual-channel LVDS support resolution up to 1920x1200 at 60 Hz
 - Analog RGB display (VGA) output up to resolution 1920 x 1200 with 60 Hz, 154 MHz pixel clock rate.
 - DisplayPort¹ interface supports the VESA DisplayPort 1.2 specification with audio up to 3200x2000 at 60 Hz
 - HDMI interface supports the HDMI 1.4a specification with audio up to 4096x2304 at 24 H
- **Gigabit Ethernet**
 - Port1: Integrated Intel 8 Series Chipset (MAC) + i218 GbE (PHY)
 - * Integrated ASF Management Controller
 - * 10/100/1000 BASE-T IEEE 802.3 specification conformance
 - * Energy Efficient Ethernet (EEE) IEEE802.3az support [Low Power Idle (LPI) mode]

- * Supports up to 9 KB jumbo frames (full duplex)
- * Supports IEEE 1588
- Port2: i210 Gigabit Ethernet Controller
 - * Flow Control Support compliant with the 802.3X Specification
 - * Compliant with the 1 Gb/s IEEE 802.3 802.3u 802.3ab Specifications
 - * Magic Packet* wake-up enable with unique MAC address
 - * Supports IEEE 1588
- **Peripheral interface**
 - MIOe Unified Expansion
 - * DisplayPort¹
 - * 1 PCIe x1
 - * 3 USB 2.0
 - * LPC
 - * HD Audio: Line out
 - * SMBus from Integrated Intel 8 Series Chipset
 - * Power: +5 Vsb/+12 Vsb, Power On, Reset
 - 2 Serial-ATA port, up to 6.0 Gb/s (600 MB/s)
 - 2 USB 3.0 and 2 USB2.0 compliant ports on rear I/O, 1 USB2.0 compliant ports for internal connection¹
 - 2 RS-232 from COM1/2, 2 RS-232/422/485 from COM3/4 (ESD protection: Air gap ±15kV, Contact ±8kV)
 - 8-bit Programmable General Purpose Input/ Output from iManager
 - 1 SMBus / I²C channel from iManager
 - Watchdog timer: Output System Reset, Programmable counter from 1 ~ 255 minutes/ seconds
 - Mini PCIe / mSATA
 - * 1 Full-size Mini PCIe (default supports mSATA)
 - * 1 Half-size Mini PCIe
- **High Definition Audio:**
 - Intel® High Definition Audio Interface
 - High Definition Audio Codec with Realtek proprietary loss-less content protection technology
 - Support 1 Line-input, 1 Line output, 1 Mic-input
- **BIOS**
 - AMI UEFI 128 Mbit

1.2.2 OS support

MIO-5271 supports Win 8, Win7, WES7

For further information about OS support of MIO-5271, please Advantech website: <http://support.advantech.com.tw/> or contact the technical support center.

1.2.3 Mechanical Specifications

- **Dimensions:** 146 x 102 mm (5.7 x 4 inches)
- **Height:** Top Side: 24 mm, PCB: 1.6mm, 47.7 mm; Bottom Side: 6.8 mm
- **Weight:** 0.84 kg (reference weight of total package)

1.2.4 Electrical Specifications

- **Power Requirement:** Single +12V DC ± 10% power input
- **Power Consumption:**

- Max load
 - * MIO-5271U-S6A1E: 1.71 A @ 12 V (20.52 W)
 - * MIO-5271U-S9A1E: 2.46 A @ 12 V (29.52 W)
- Idle mode
 - * MIO-5271U-S6A1E: 0.38 A @ 12 V (4.56 W)
 - * MIO-5271U-S9A1E: 0.39 A @ 12 V (4.68 W)
- **Power Consumption Conditions:**
 - Test software: 3DMark 2006
 - Max. load: Measure the maximum current value which system under maximum load (CPU: Top speed, RAM & Graphic: Full loading)
 - Idle mode: Measure the current value when system in windows mode and without running any program
- **RTC Battery:**
 - Typical Voltage: 3.0 V
 - Normal discharge capacity: 210 mAh

1.2.5 Environmental

- **Operating temperature:** 0 ~ 60°C (32 ~ 140°F)
- **Operating Humidity:** 40°C @ 85% RH Non-Condensing
- **Storage Temperature:** Storage temperature: -40~85°C
- **Storage Humidity:** Relative humidity: 95% @ 60°C

¹ It will not be supported in default, please contact to Advantech if this function is needed.

² Thermal condition need to be considered when setting max frequency.

1.3 Block Diagram

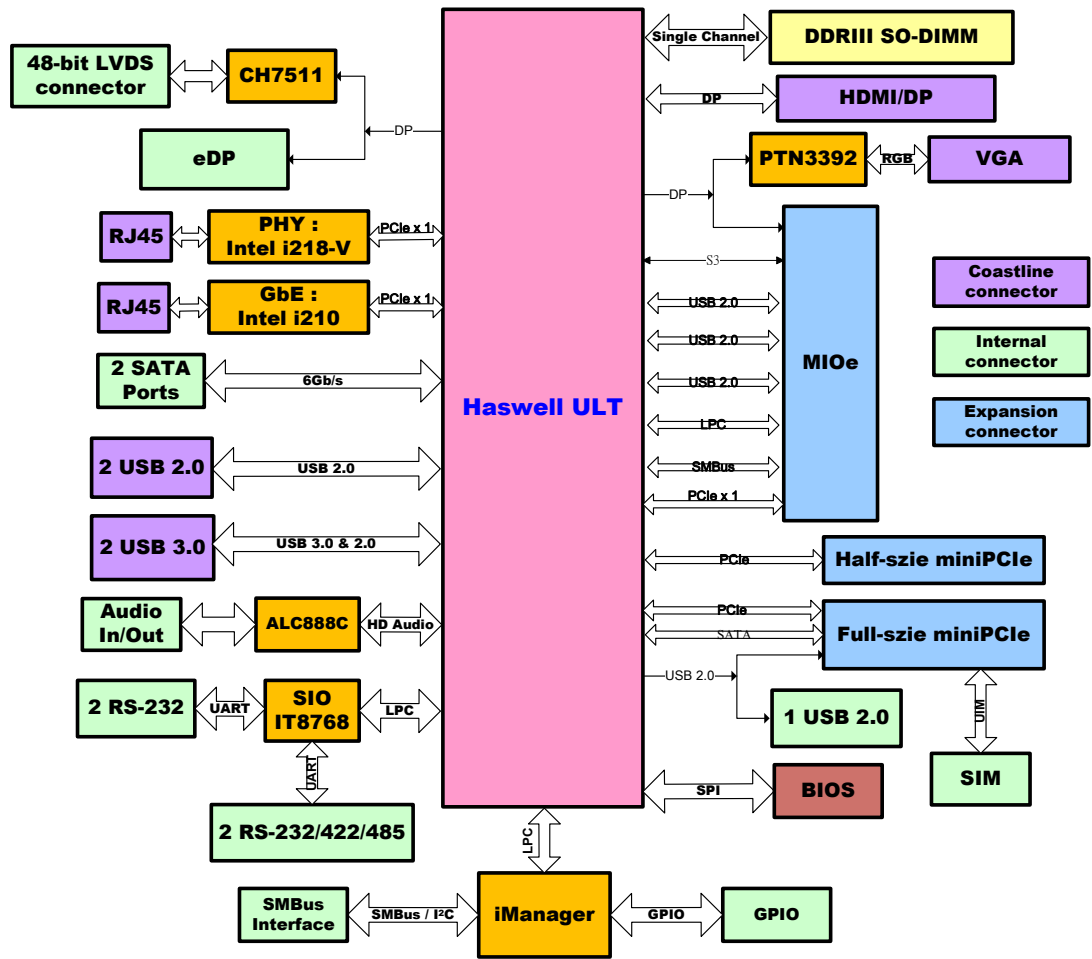

1.4 Board layout: dimensions

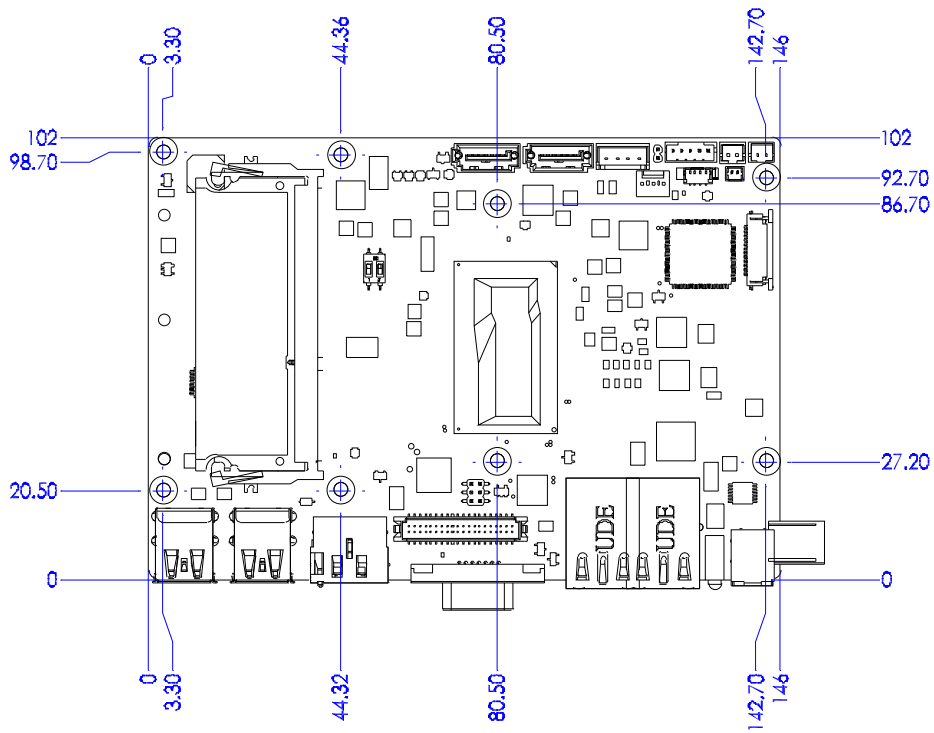

Figure 1.1 MIO-5271 Mechanical Drawing (Top Side)

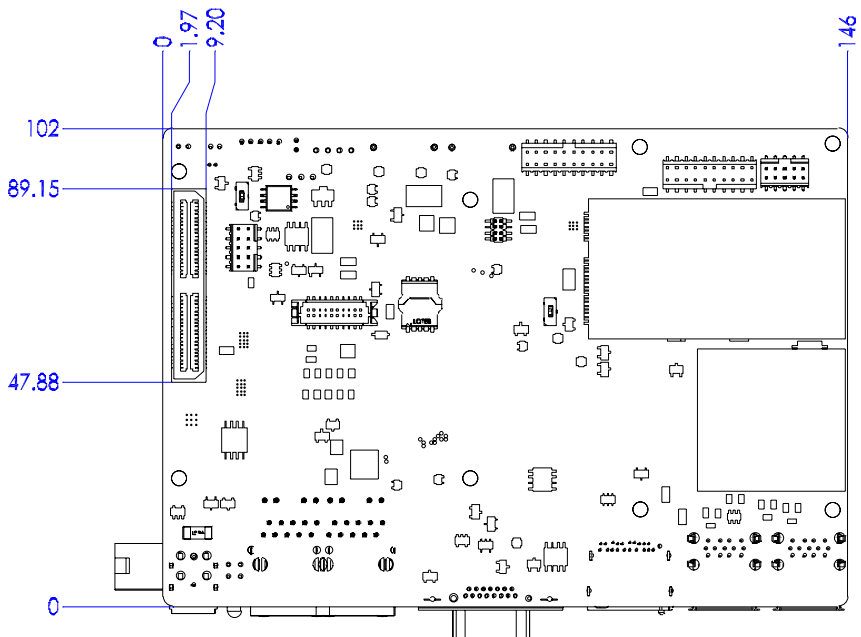

Figure 1.2 MIO-5271 Mechanical Drawing (Bottom Side)

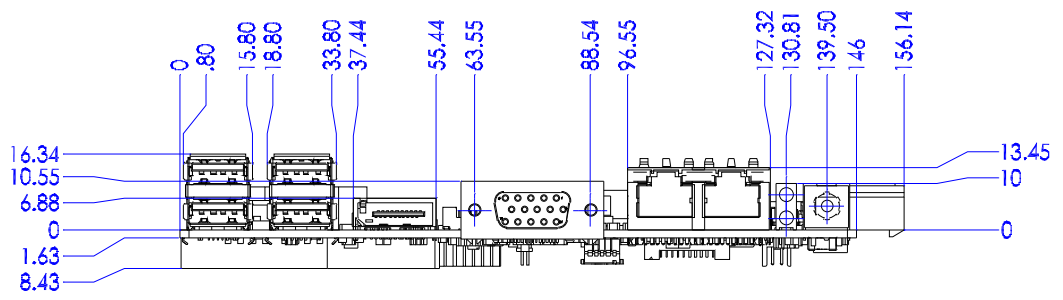

Figure 1.3 MIO-5271 Mechanical Drawing (Coastline)

Chapter 2

Installation

This chapter explains the setup procedures of the MIO-5271 hardware, including instructions on setting jumpers and connecting peripherals, switches and indicators. Be sure to read all safety precautions before you begin the installation procedure.

2.1 Jumpers & Switches

The MIO-5271 has a number of jumpers that allow you to configure your system to suit your application. The table below lists the functions of the various jumpers.

Table 2.1: Jumpers & Switches

J2	Auto Power On Setting
J3	LCD Power
SW2	mPCIe & mSATA selection
SW3	Clear CMOS

2.2 Connectors

Onboard connectors link the MIO-5271 to external devices such as hard disk drives, a keyboard, or floppy drives. The table below lists the function of each of the board's connectors.

Table 2.2: Connectors

Label	Function
CN1	12V Power Input
CN5	Power Switch
CN7	Reset
CN8	GPIO
CN9	VGA
CN10	HDMI/DisplayPort
CN11	SATA2
CN12	SATA1
CN13	SATA Power
CN14	Full-Size Mini PCIE w/ mSATA
CN15	SIM
CN16	External USB2.0+USB3.0
CN17	External USB2.0+USB3.0
CN18	COM1/COM2
CN19	COM3/COM4
CN21	Gigabit Ethernet 1 & 2
CN23	Audio
CN24	MIOe
CN25	Inverter Power Output
CN26	LVDS
CN29	SMBus/I ² C
CN31	Half-Size Mini PCIE
FAN1	System FAN

2.3 Locating connectors & block diagram

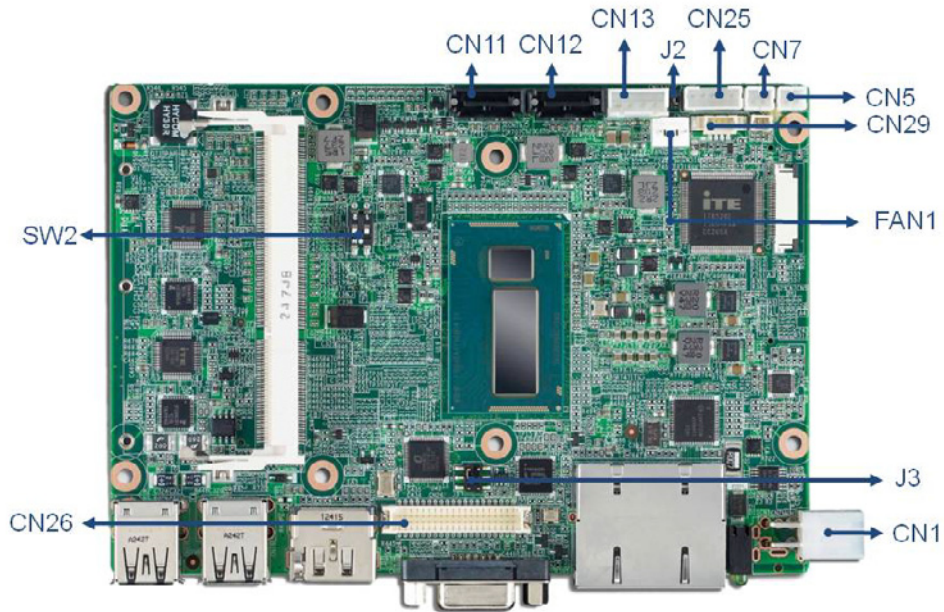

Figure 2.1 MIO-5271 Connector Locations (Top Side)

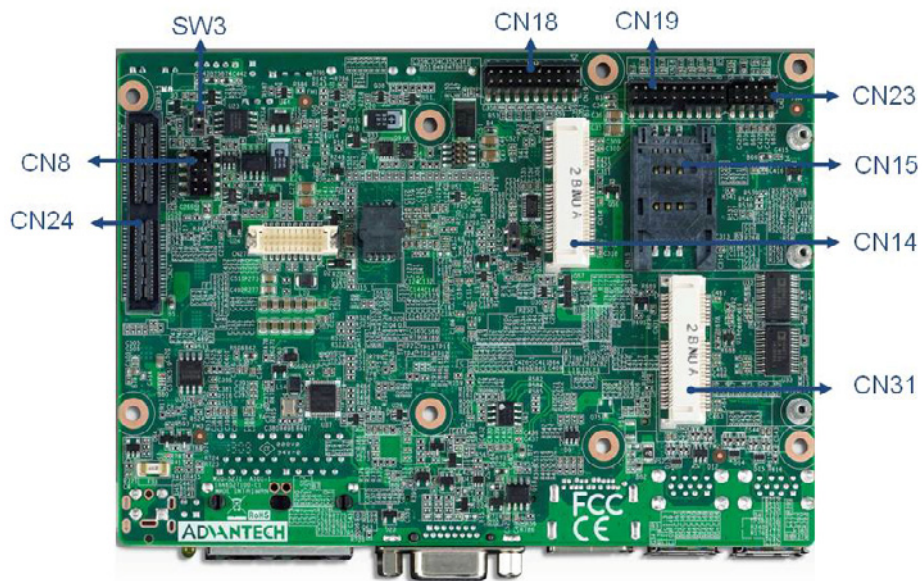

Figure 2.2 MIO-5271 Connector Locations (Bottom Side)

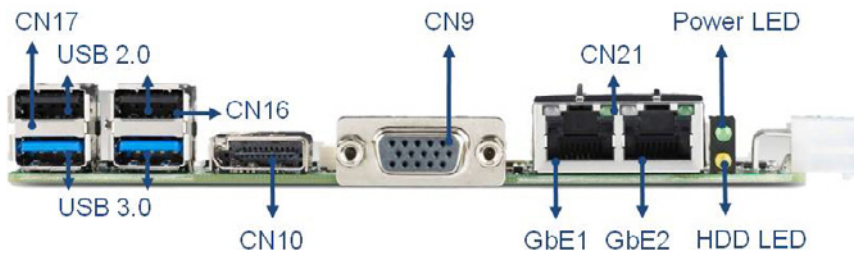
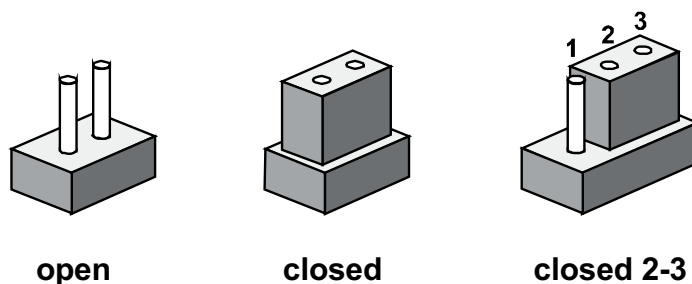

Figure 2.3 MIO-5271 Connector Locations (Coastline)

2.4 Setting Jumpers

You may configure your card to match the needs of your application by setting jumpers. A jumper is a metal bridge used to close an electric circuit. It consists of two metal pins and a small metal clip (often protected by a plastic cover) that slides over the pins to connect them. To “close” a jumper, you connect the pins with the clip. To “open” a jumper, you remove the clip. Sometimes a jumper will have three pins, labeled 1, 2 and 3. In this case you would connect either pins 1 and 2, or 2 and 3.

The jumper settings are schematically depicted in this manual as follows:



A pair of needle-nose pliers may be helpful when working with jumpers. If you have any doubts about the best hardware configuration for your application, contact your local distributor or sales representative before you make any changes. Generally, you simply need a standard cable to make most connections.

2.4.1 Auto Power On Setting (J2)



Table 2.3: Auto Power On Setting (J2)

Setting	Function
NC	Power Button for Power On
(1-2)*	Auto Power On (default)

2.4.2 LCD Power (J3)

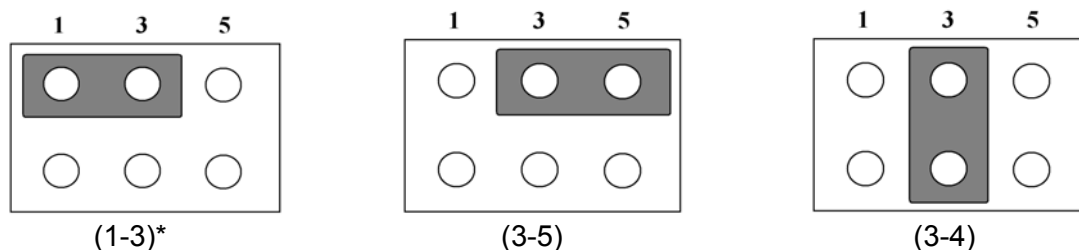
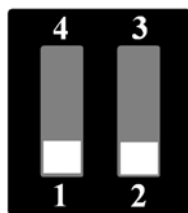

Table 2.4: LCD Power (J3)

Setting	Function
(1-3)*	+3.3V (default)
(3-5)	+5V
(3-4)	+12V

2.4.3 PCIe & mSATA Selection (SW2)



(1 & 2)*

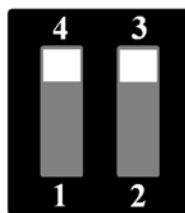

(3 & 4)

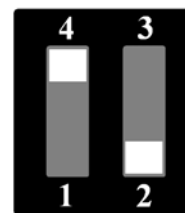

(2 & 4)

Table 2.5: mPCIe & mSATA Selection (SW2)

Setting	Function
(1 & 2)*	mSATA (default)
(3 & 4)	mPCIe
(2 & 4)	Auto Detect ¹

¹ Some of mSATA or mPCIe modules can't be recognized correctly through Auto Detect setting. We suggest to use mSATA or mPCIe setting directly if you meet any compatibility problems.

2.4.4 Clear CMOS (SW3)

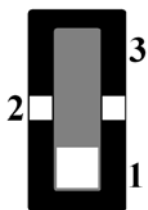

(1-2)*

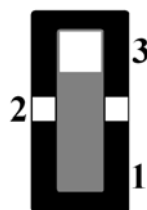

(2-3)

Table 2.6: Clear CMOS (SW3)

Setting	Function
(1-2)*	Normal
(2-3)	Clear CMOS

Chapter 3

AMI BIOS Setup

AMIBIOS has been integrated into many motherboards for over a decade. With the AMIBIOS Setup program, you can modify BIOS settings and control the various system features. This chapter describes the basic navigation of the MIO-5271 BIOS setup screens.



Figure 3.1 Setup program initial screen

AMI's BIOS ROM has a built-in Setup program that allows users to modify the basic system configuration. This information is stored in battery-backed CMOS so it retains the Setup information when the power is turned off.

3.1 Entering Setup

Turn on the computer and then press <F2> or to enter Setup menu.

3.2 Main Setup

When you first enter the BIOS Setup Utility, you will encounter the Main setup screen. You can always return to the Main setup screen by selecting the Main tab. There are two Main Setup options. They are described in this section. The Main BIOS Setup screen is shown below.

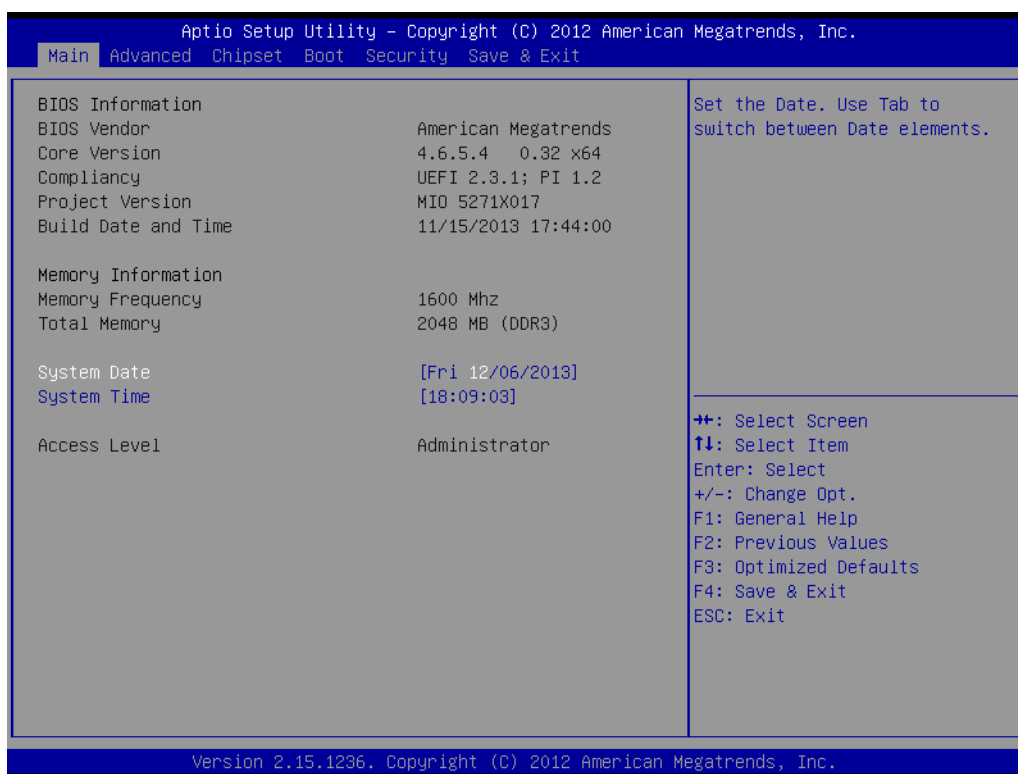

Figure 3.2 Main setup screen

The Main BIOS setup screen has two main frames. The left frame displays all the options that can be configured. Grayed-out options cannot be configured; options in blue can. The right frame displays the key legend.

Above the key legend is an area reserved for a text message. When an option is selected in the left frame, it is highlighted in white. Often a text message will accompany it.

3.2.1 System time / System date

Use this option to change the system time and date. Highlight System Time or System Date using the <Arrow> keys. Enter new values through the keyboard. Press the <Tab> key or the <Arrow> keys to move between fields. The date must be entered in MM/DD/YY format. The time must be entered in HH:MM:SS format.

3.3 Advanced BIOS Features Setup

Select the Advanced tab from the MIO-5271 setup screen to enter the Advanced BIOS Setup screen. You can select any of the items in the left frame of the screen, such as CPU Configuration, to go to the sub menu for that item. You can display an Advanced BIOS Setup option by highlighting it using the <Arrow> keys. All Advanced BIOS Setup options are described in this section. The Advanced BIOS Setup screens is shown below. The sub menus are described on the following pages.

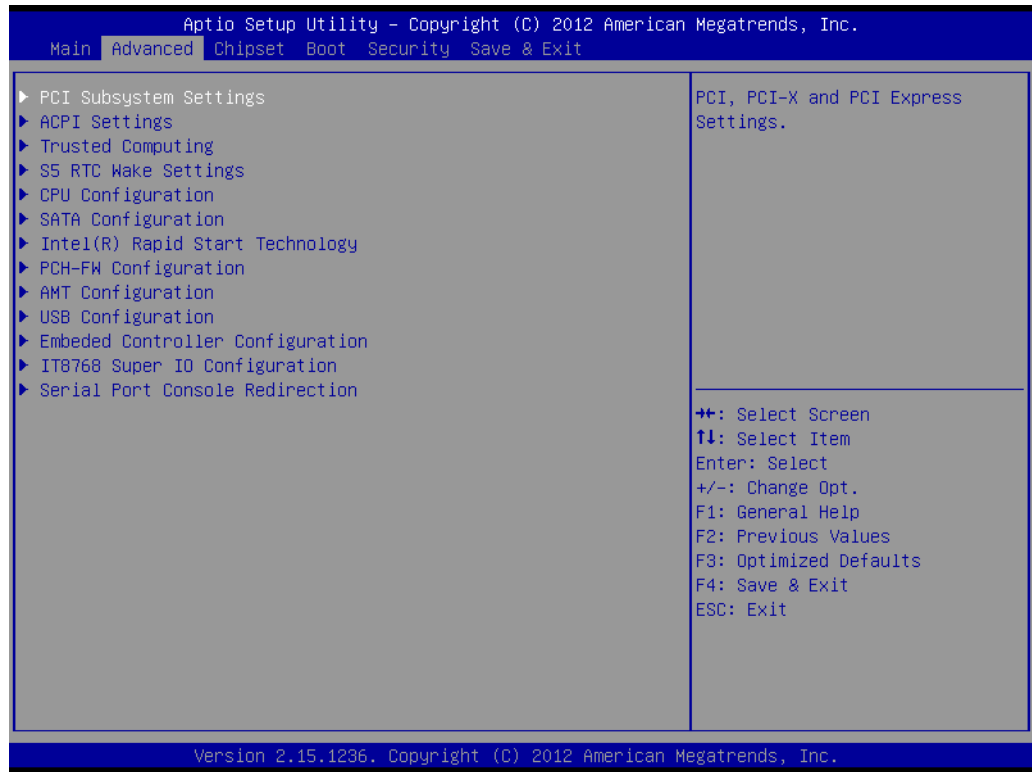

Figure 3.3 Advanced BIOS features setup screen

3.3.1 PCI Subsystem Settings

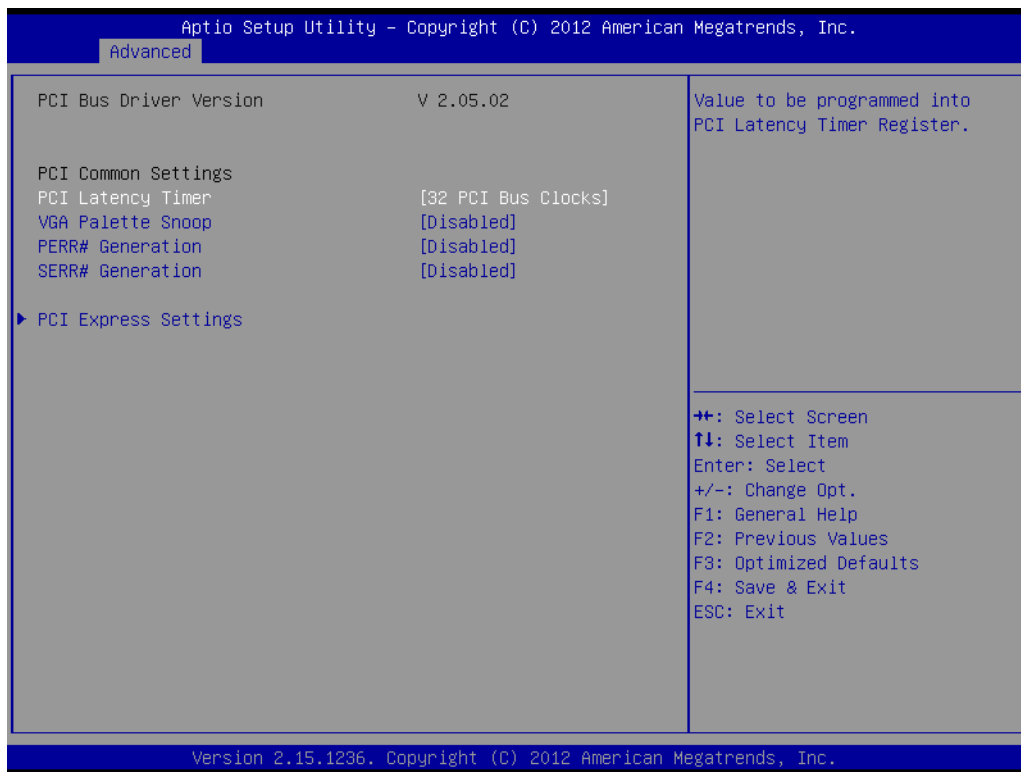

Figure 3.4 PCI Subsystem Settings

PCI Latency Timer

This item allows users to programmed PCI Latency timer.

VGA Palette Snoop

This item allows users to enable or disable VGA Palette Snoop.

PERR# Generation

This item allows users to enable or disable PERR# Generation.

SERR# Generation

This item allows users to enable or disable SERR# Generation.

3.3.2 PCI Express Device Register Settings



Figure 3.5 PCI Express Device Register Settings

Relaxed Ordering

Enable or disable Relaxed Ordering

Extended Tag

Enable or disable Extended Tag

No Snoop

Enable or disable No Snoop

Maximum Payload

This item allows users to set the Maximum Payload

Maximum Read Request

This item allows users to set the Maximum Read Request

ASPM Support

Enable or disable ASPM Support

Extended Synch

Enable or disable Extended Synch

Link Training Retry

This item allows users to set the Link Training Retry

Link Training Timeout (uS)

This item allows users to set the Link Training Timeout (uS)

Unpopulated Links

This item allows users to set the Unpopulated Links

Restore PCIE Registers

Enable or disable Restore PCIE Registers

3.3.3 ACPI Settings

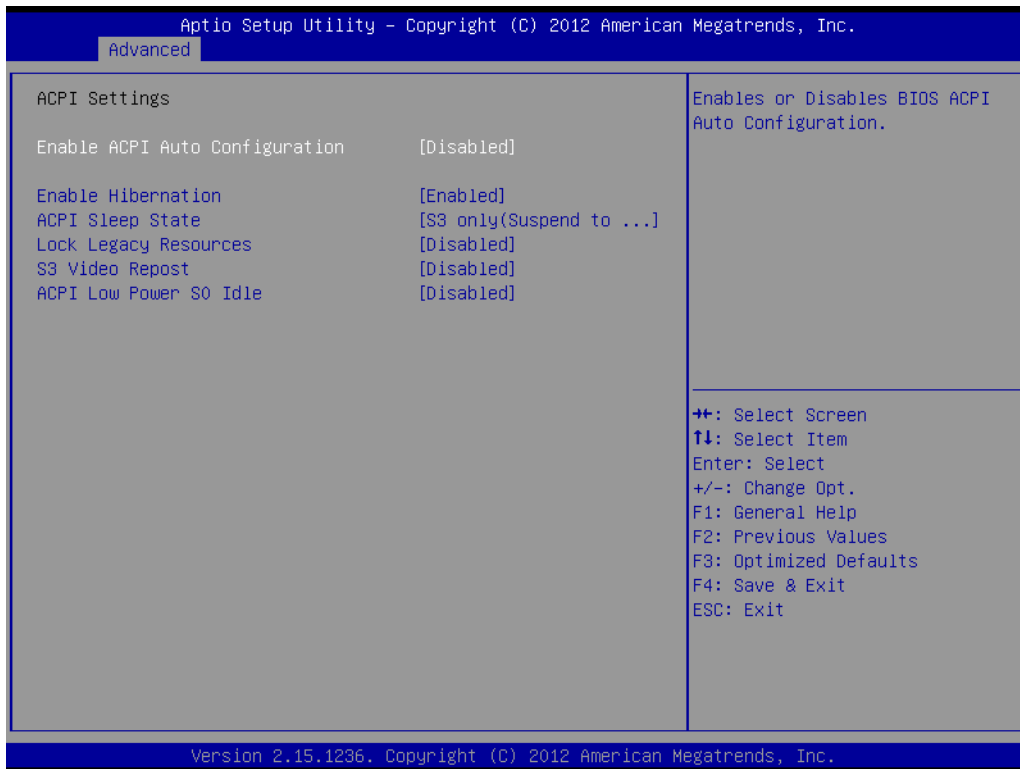

Figure 3.6 ACPI Setting

Enable ACPI Auto Configuration

This item allows users to enable or disable BIOS ACPI auto configuration.

Enable Hibernation

This item allows users to enable or disable hibernation.

ACPI Sleep State

This item allows users to set the ACPI sleep state.

Lock Legacy Resources

This item allows users to lock legacy devices' resources.

S3 Video Repost

This item allows users to enable or disable VBIOS run after S3 resume.

ACPI Low Power S0 Idle

This item allows users to enable or disable system wake on alarm event by Items setting.

3.3.4 Trusted Computing

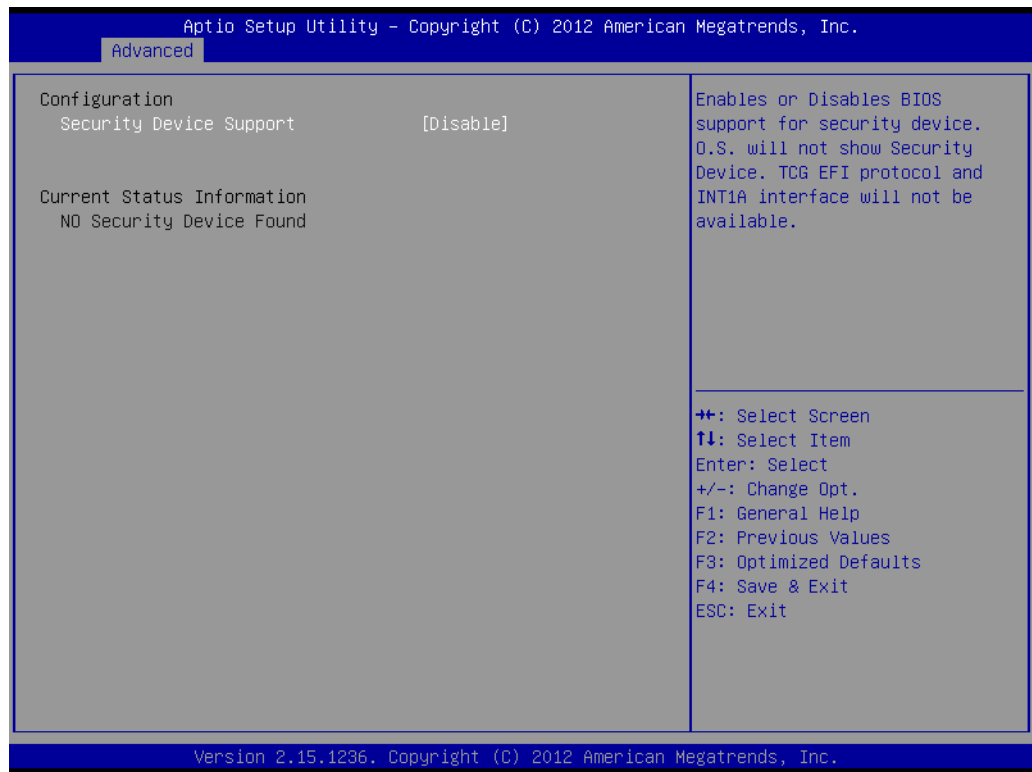

Figure 3.7 Trusted Computing Configuration

Security Device Support

Enable or disable BIOS support for security device.

3.3.5 S5 RTC Wake Settings



Figure 3.8 S5 RTC Wake Settings

Wake system with fixed time

Enable or disable system wake on alarm event

3.3.6 CPU Configuration

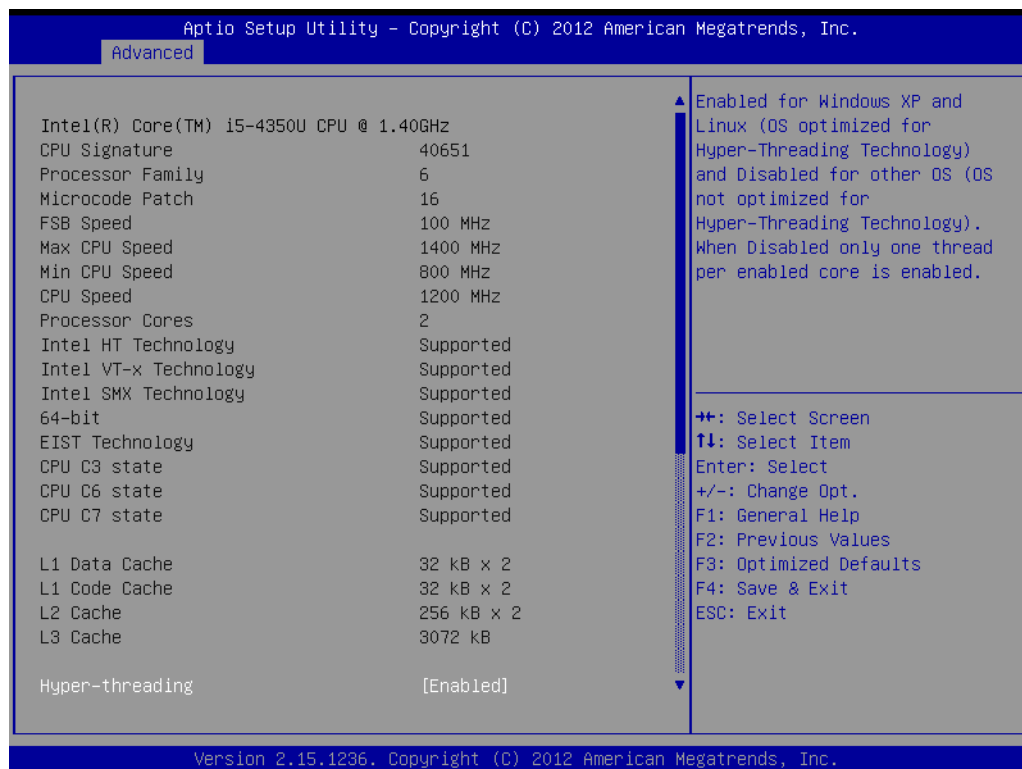

Figure 3.9 CPU Configuration Setting

Hyper Threading Technology

This item allows users to enable or disable Intel? Hyper Threading technology.

Active Processor Cores

This item allows users to set how many processor cores should be active.

Limit CPUID Maximum

This item allows users to limit the maximum value of CPUID.

Execute Disable Bit

This item allows users to enable or disable the No-Execution page protection technology.

Intel Virtualization Technology

This item allows users to enable or disable the intel virtualization technology.

Hardware Prefetcher

This item allows users to enable or disable the hardware prefetcher feature.

Adjacent Cache Line Prefetch

This item allows users to enable or disable the adjacent cache line prefetch feature.

3.3.7 SATA Configuration

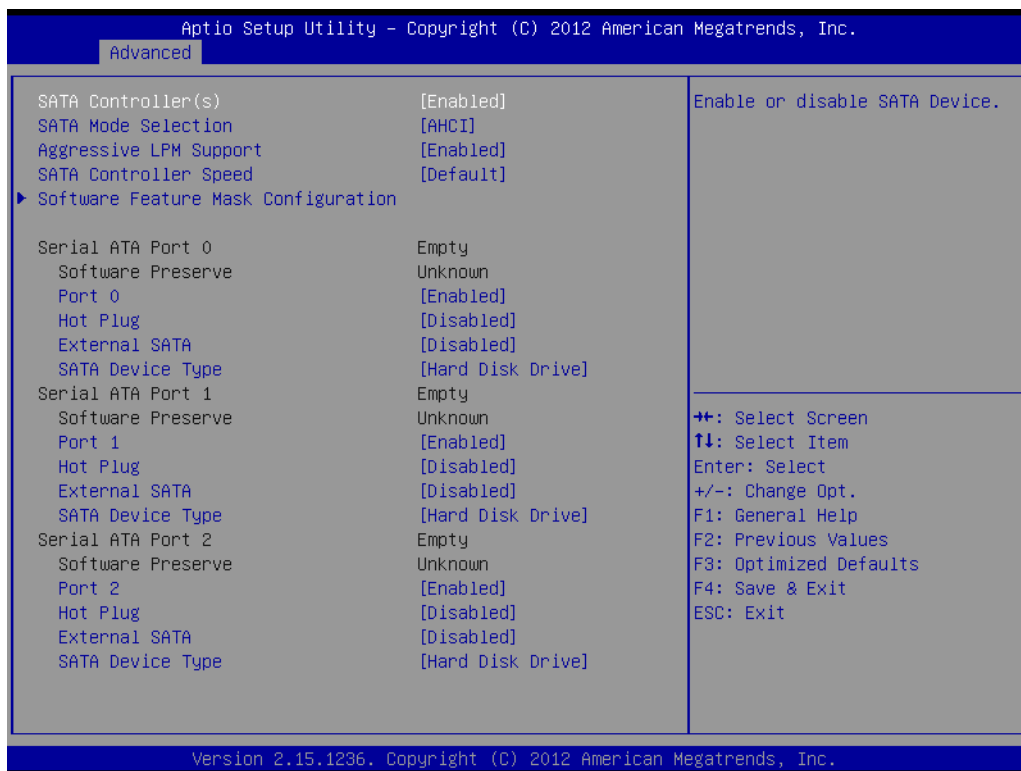

Figure 3.10 SATA Configuration

SATA Controller(s)

This item allows users to enable or disable the SATA controller(s).

SATA Mode Selection

This item allows users to select mode of SATA controller(s).

SATA Controller(s)

This item allows users to enable or disable the SATA controller(s).

SATA Mode Selection

This item allows users to select mode of SATA controller(s).

Aggressive LPM Support

This item allows users to enable or disable the Aggressive LPM Support.

SATA Controller Speed

This item allows users to select mode of SATA Controller Speed.

Serial ATA Port 1/2/3

This item allows users to enable or disable the SATA Port.

Hot Plug

This item allows users to enable or disable the Hot Plug.

External SATA

This item allows users to enable or disable the External SATA.

SATA Device type

This item allows users to select mode of SATA Device type.

3.3.8 AMT Configuration

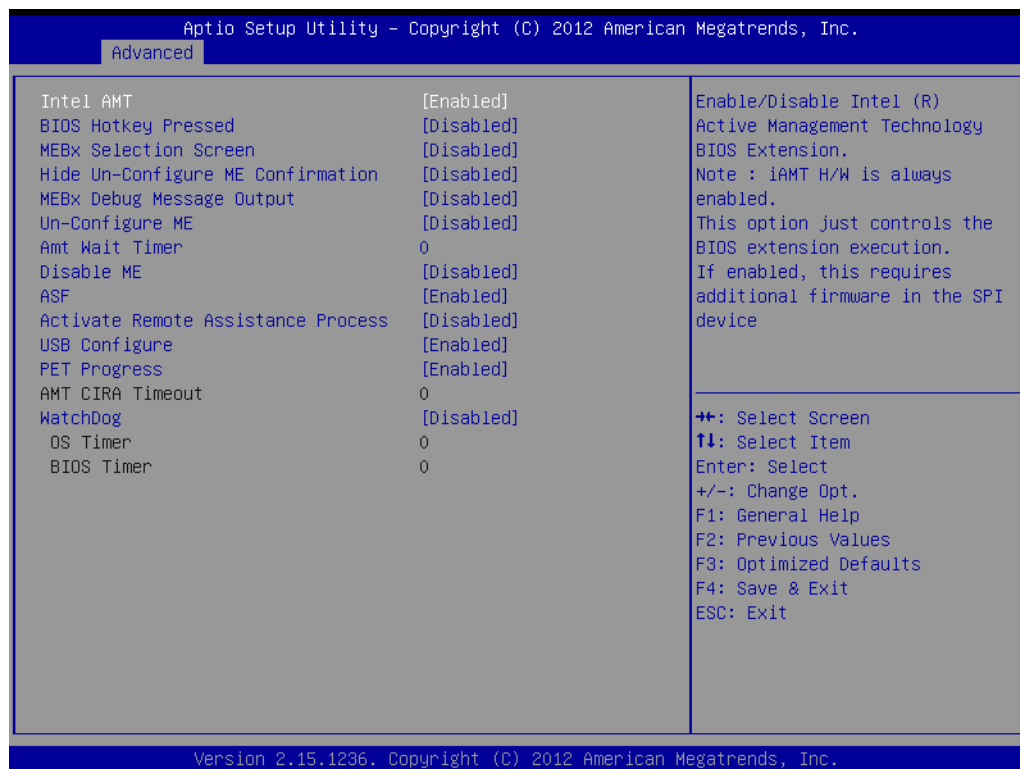

Figure 3.11 AMT Configuration

Intel AMT

This item allows users to enable or disable Intel AMT BIOS extension.

BIOS Hotkey Pressed

This item allows users to enable or disable BIOS hotkey press.

MEBx Selection Screen

This item allows users to enable or disable MEBx selection screen.

Hide Un-Configuration ME Confirmation

This item allows users to hide un-configure ME without password confirmation prompt.

MEBx Debug Message Output

This item allows users to enable or disable MEBx debug message.

Un-Configure ME

This item allows users to un-configure ME without password.

Amt Wait Timer

Set timer to wait before sending ASF_GET_BOOT_OPTIONS.

Disable ME

This item allows users to enable or disable Intel ME.

ASF

This item allows users to enable or disable Alert Specification Format.

Activate Remote Assistance Process

This item allows users to enable or disable trigger CIRA boot.

USB Configure

This item allows users to enable or disable USB configure function.

PET Progress

This item allows users to enable or disable PET events progress to receive PET events or not.

AMT CIRA Timeout

OEM defined timeout for MPS connection to be established.

WatchDog

This item allows users to enable or disable WatchDog Timer.

OS Timer

Set OS watchdog timer.

BIOS Timer

Set BIOS watchdog timer.

3.3.9 PCH-FW Configuration

Figure 3.12 PCH-FW Configuration

Firmware Update Configuration

This item allows users to enable or disable ME FW image re-flash function.

3.3.10 Intel® Rapid Start Technology

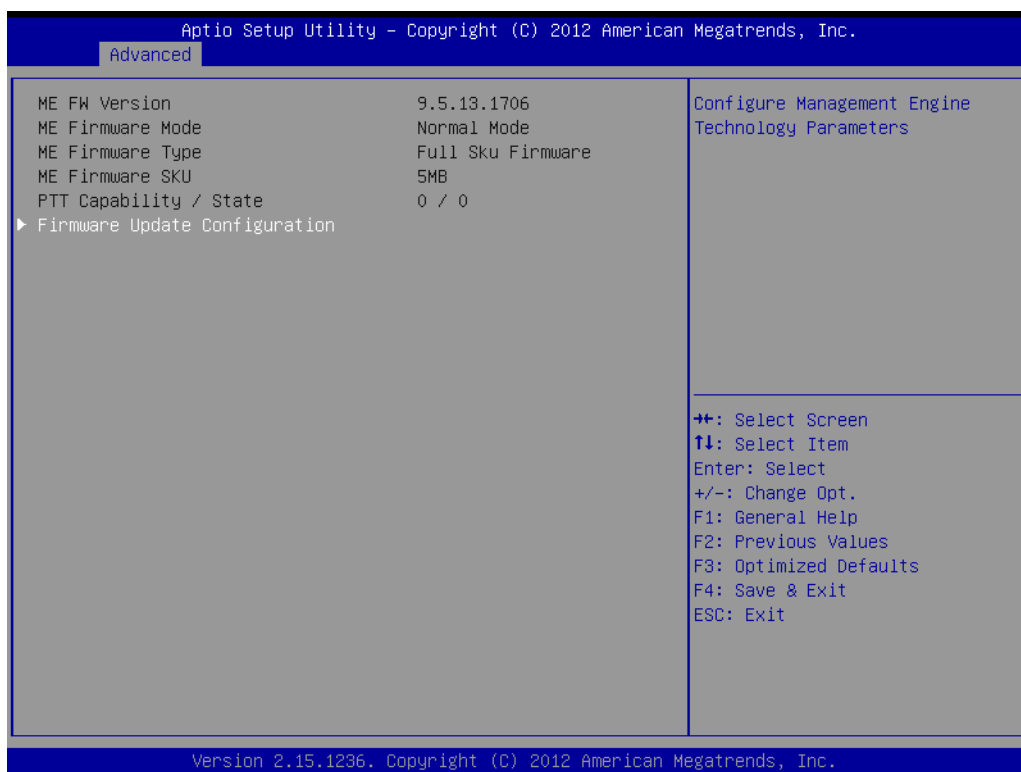
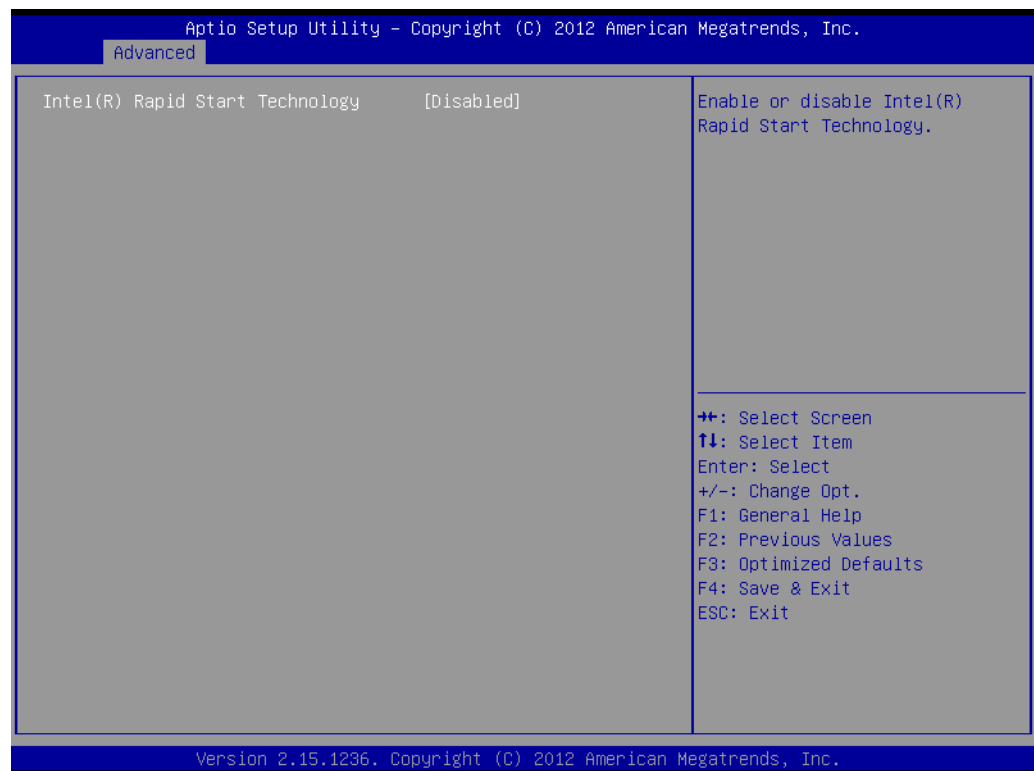

Figure 3.13 Intel® Rapid Technology

Intel® Rapid Start Technology

This item allows users to enable or disable Rapid Start Technology, if supported.

3.3.11 USB Configuration

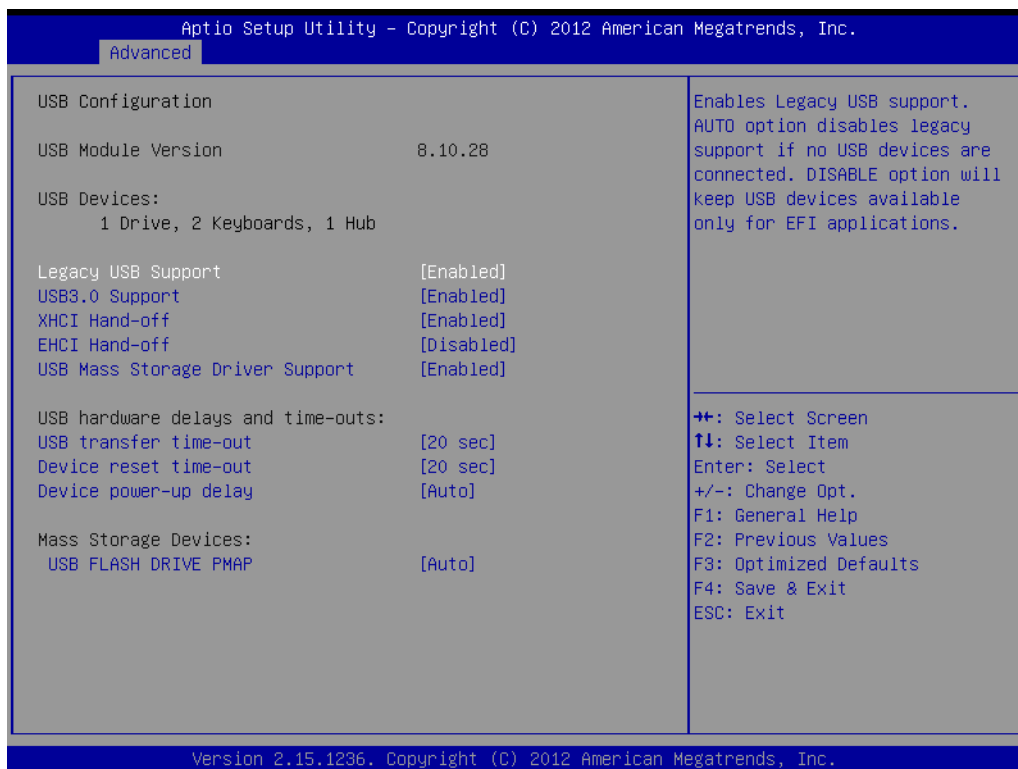

Figure 3.14 USB Configuration

Legacy USB Support

Enable the support for legacy USB. Auto option disables legacy support if no USB devices are connected.

USB3.0 Support

This item allows users to enable or disable USB3.0 support.

XHCI Hand-Off

This is a workaround for the OS without XHCI hand-off support. The XHCI ownership change should claim by XHCI driver.

EHCI Hand-Off

This is a workaround for the OS without EHCI hand-off support. The EHCI ownership change should claim by EHCI driver.

USB transfer time-out

Set the time-out value for Control, Bulk, and Interrupt transfers.

Device reset time-out

Set USB mass storage device Start Unit command time-out value.

Device power-up delay

Set the maximum time of the device will take before it properly reports itself to the Host Controller. 'Auto' uses default value: for a Root port it is 100 ms, for a Hub port the delay is taken from Hub descriptor.

3.3.12 Embedded Controller Configuration

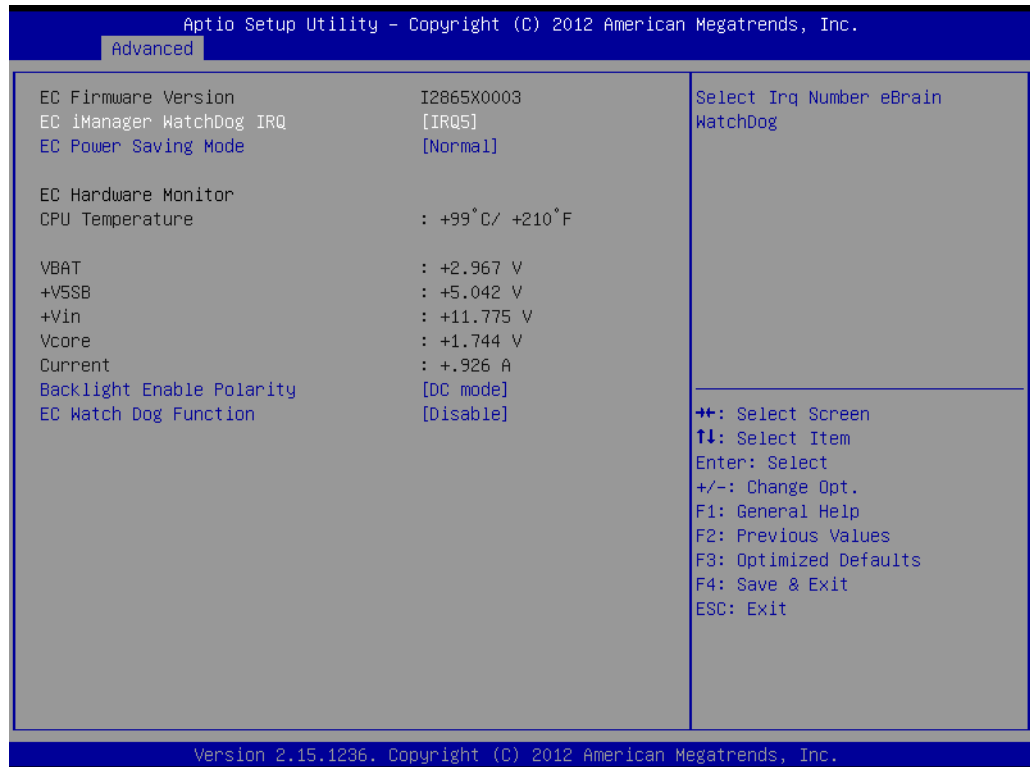

Figure 3.15 Embedded Controller Configuration

EC iManager WatchDog IRQ

This item allows users to set the IRQ number of EC watchdog.

EC Power Saving Mode

This item allows users to set board's power saving mode when off.

Backlight Mode

This item allows users to set backlight Function.

EC Watch Dog Function

This item allows users to select EC watchdog timer.

3.3.13 Super IO Configuration

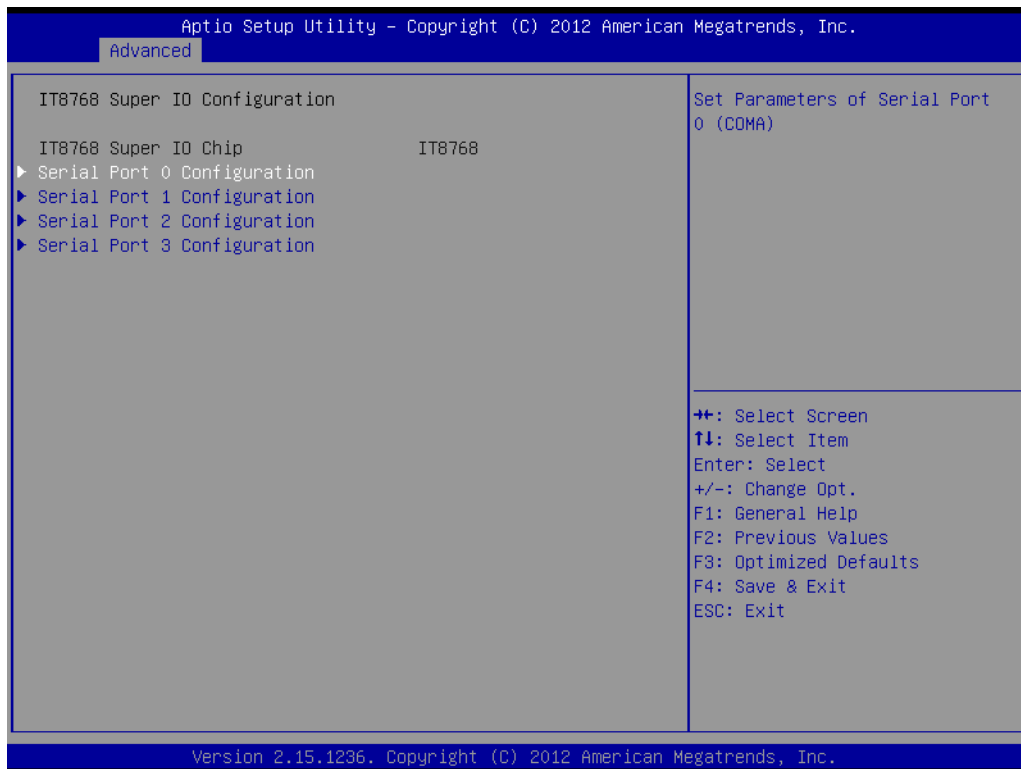

Figure 3.16 Super IO Configuration

Serial Port 1 Configuration

This item allows users to configure serial port 1.

Serial Port 2 Configuration

This item allows users to configure serial port 2.

Serial Port 3 Configuration

This item allows users to configure serial port 3.

Serial Port 4 Configuration

This item allows users to configure serial port 4.

3.3.14 Serial Port Console Redirection

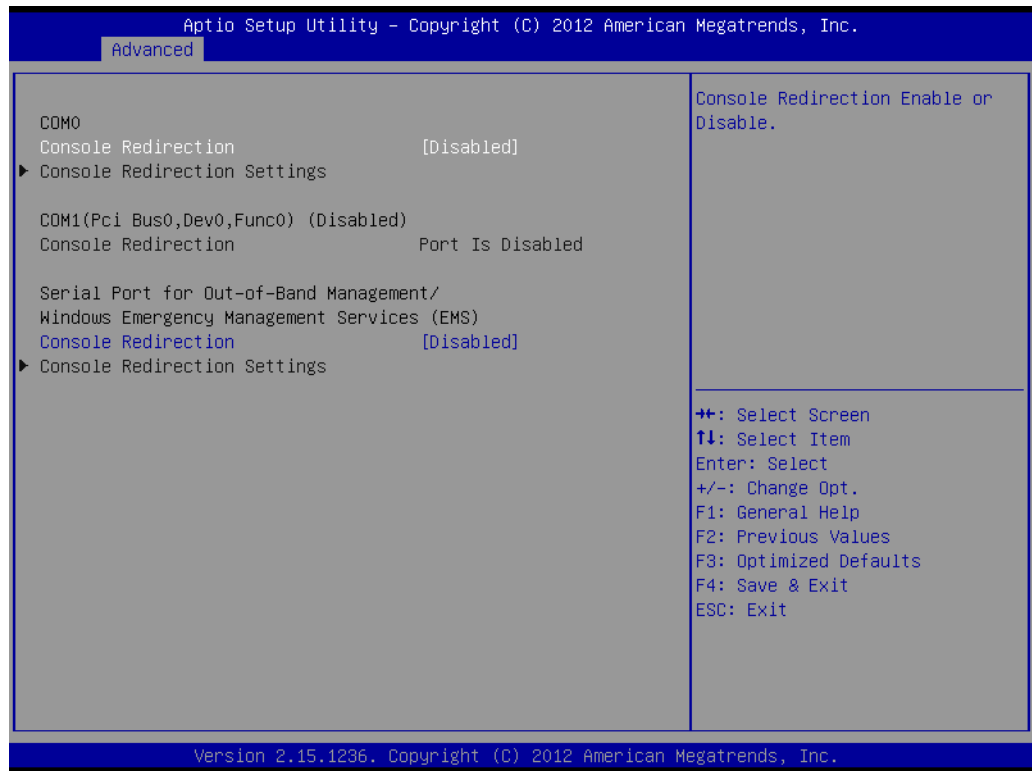

Figure 3.17 Serial Port Console Redirection

Console Redirection

This item allows users to enable or disable console redirection for Microsoft Windows Emergency Management Services (EMS).

Console Redirection

This item allows users to configuration console redirection detail settings.

3.4 Chipset

Select the Chipset tab from the MIO-5271 setup screen to enter the Chipset BIOS Setup screen. You can display a Chipset BIOS Setup option by highlighting it using the <Arrow> keys. All Plug and Play BIOS Setup options are described in this section. The Plug and Play BIOS Setup screen is shown below.

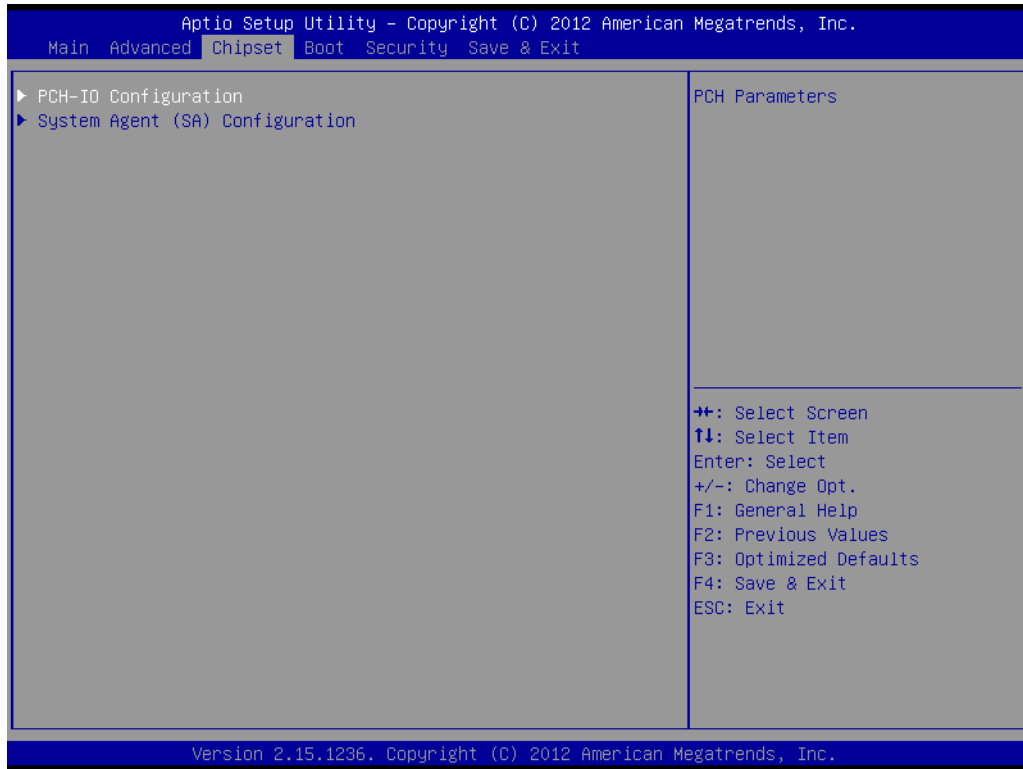

Figure 3.18 Chipset Setup

3.4.1 System Agent (SA) Configuration

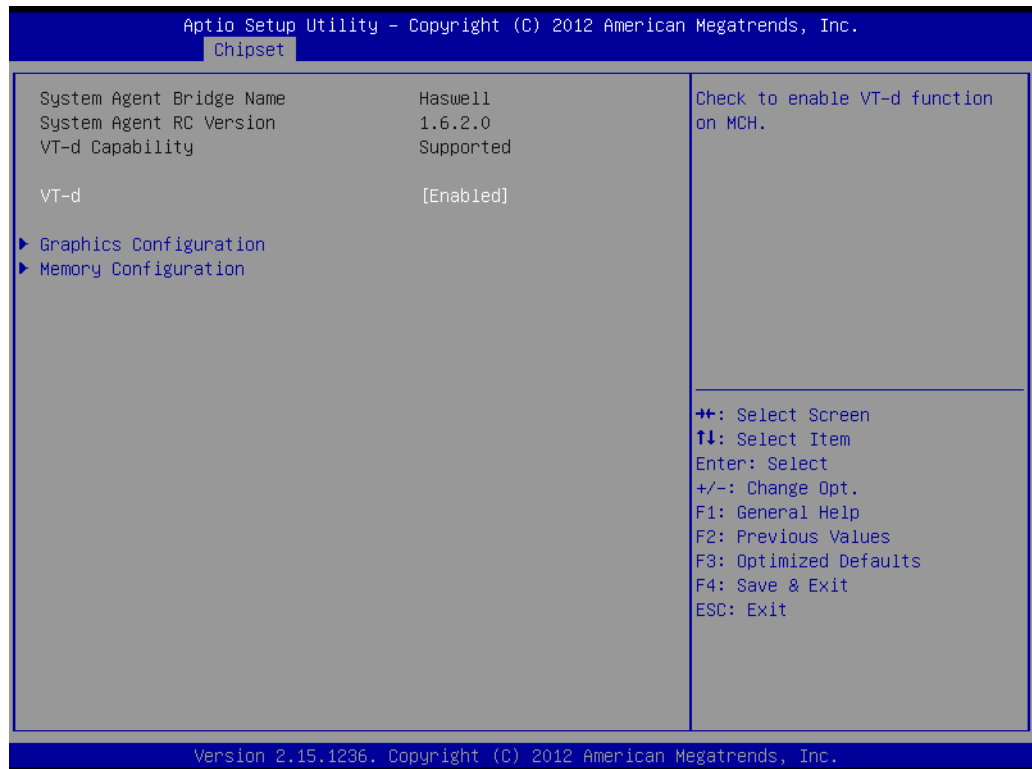

Figure 3.19 System Agent (SA) Configuration

VT-d

This item allows users to enable or disable VT-d.

3.4.1.1 Intel IGFx Configuration

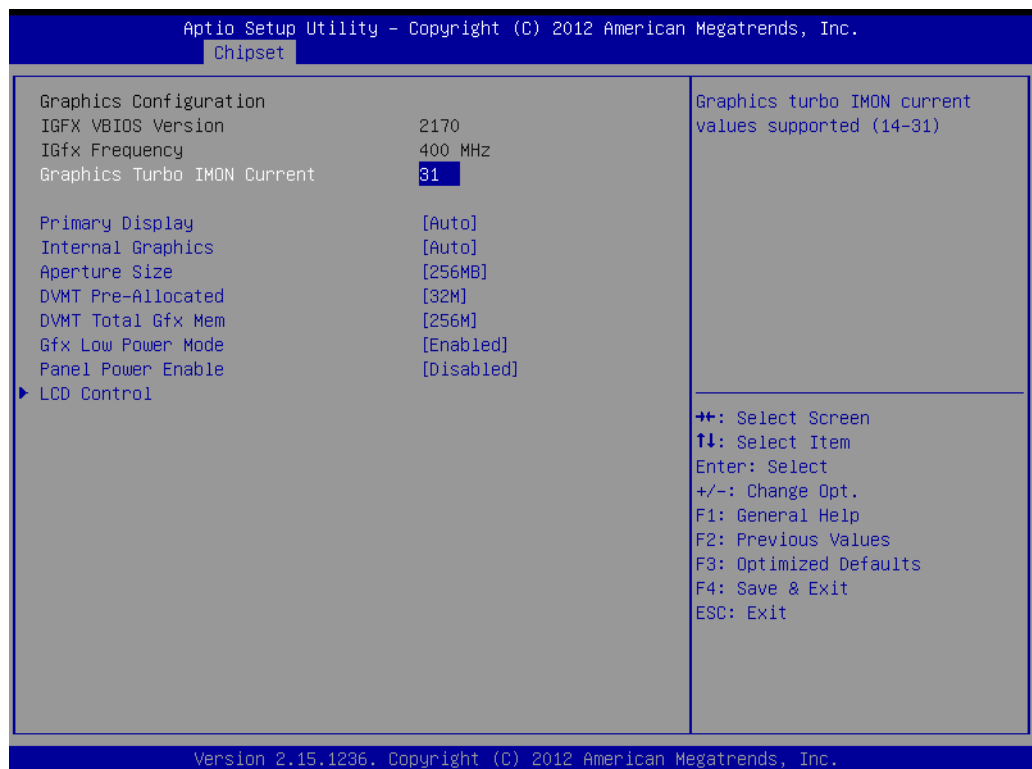

Figure 3.20 Intel IGFx Configuration

Graphics Turbo IMON Current

This item allows users to select which Graphics Turbo IMON Current.

Primary Display

This item allows users to select Primary Display.

Internal Graphics

This item allows users to enable or disable IGD.

Aperture Size

This item allows users to select aperture size.

DVMT Pre-Allocated

This item allows users to select DVMT pre-allocated memory size.

DVMT Total Gfx Mem

This item allows users to select DVMT total memory size.

Panel Power Enable

This item allows users to enable or disable Panel Power. Graphics Performance

Analyzers

This item allows users to enable or disable Graphics Performance Analyzers

LCD Control

Figure 3.21 LCD Control

Primary IGFX Boot Display

Select boot display device at post stage.

LVDS

This item allows user to enable or disable LVDS

LCD Panel Type

This item allows users to select panel resolution.

3.4.1.2 Memory Configuration

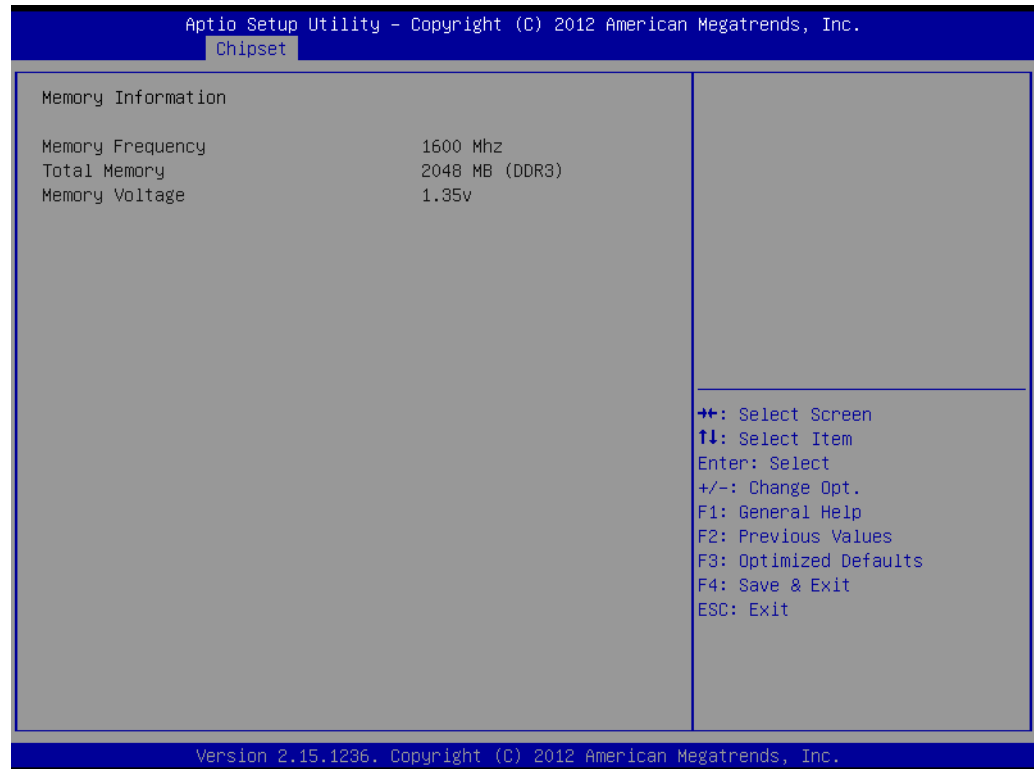

Figure 3.22 Memory Configuration

Memory Information

This item shows memory configuration parameters.

3.4.2 PCH-IO Configuration

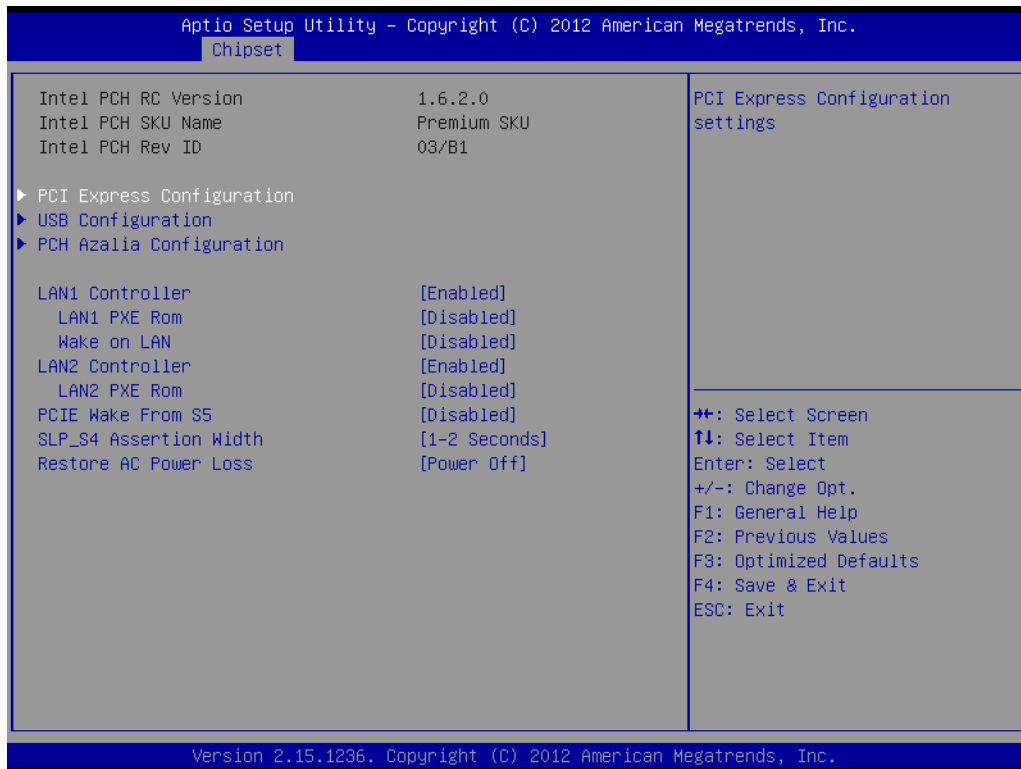

Figure 3.23 PCH-IO Configuration

PCI Express Clock Gating

This item allows users to enable or disable PCI Express Clock Gating for each root port.

PCI Express Configuration

This item allows users to configuration PCIE1~PCIE8 root port detail settings.

USB Configuration

This item allows users to configuration detail of USB functions.

PCH Azalia Configuration

This item allows users to configuration detail of azalia functions.

LAN 1/2 controller

Enables or disables the LAN 1/2 controller.

Wake on LAN

Enables or disables LAN1 wake up from sleep state.

LAN 1/2 PXE Rom

This item allows users to enable or disable PXE Rom for LAN 1/2.

PCIE Wake from S5

Enables or disables PCIE device wake up from S5.

SLP_S4 Assertion Width

This item allows users to set a delay of sorts.

Restore AC Power Loss

This item allows users to select off, on and last state.

3.4.2.1 PCI Express Configuration

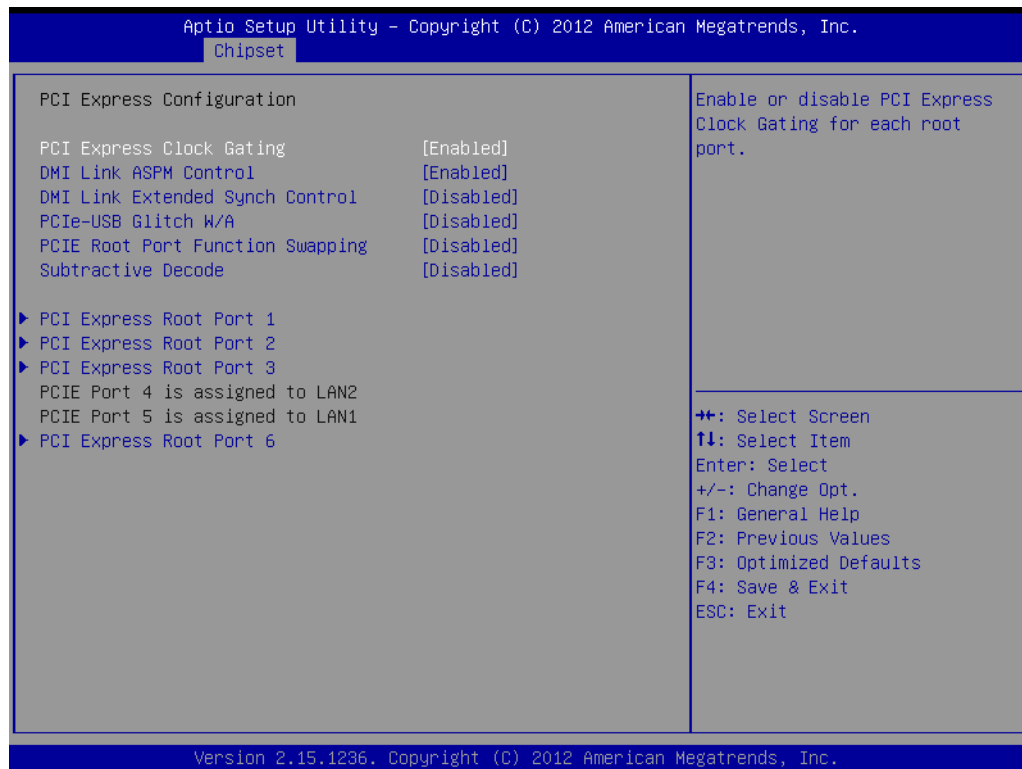

Figure 3.24 PCI Express Configuration

PCI Express Clock Gating

This item allows users to enable or disable PCI Express Clock Gating for each root port.

DMI Link ASPM Control

This item allows users to enable or disable the DMI Link ASPM Control.

DMI Link Extended Synch Control

This item allows users to configure Mini PCI Express setting.

PCIe-USB Glitch W/A

This item allows users to enable or disable PCIe-USB Glitch W/A. PCIe-USB Glitch W/A for bad USB device(s) connected behind PCIe/PEG Port.

Subtractive Decode

This item allows users to enable or disable Subtractive Decode.

PCI Express Root Port 1/2/3/6

This item allows users to configure PCI Express Root port 1/2/3/6 setting.

3.4.2.2 USB Configuration

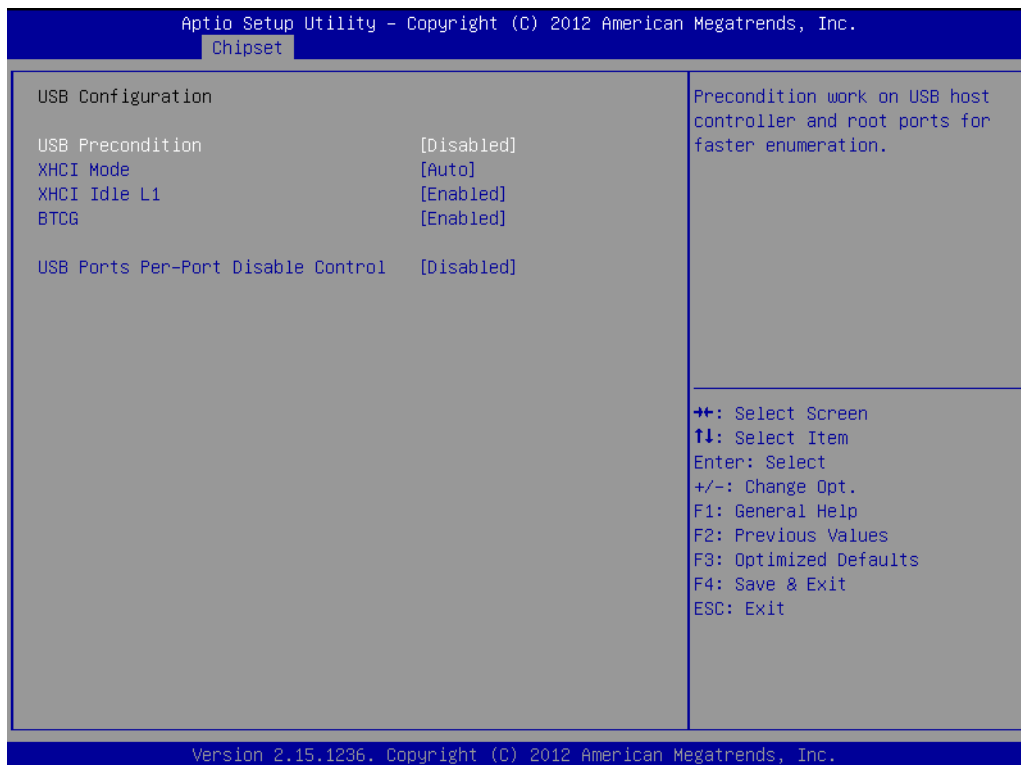

Figure 3.25 USB Configuration

USB Precondition

This item allows users to enable or disable USB Precondition. Precondition work on USB host controller and root ports for faster enumeration.

XHCI Mode

This item allows users to select mode of operation of XHCI mode.

XHCI Idle L1

This item allows users to enable or disable XHCI Idle L1. XHCIIDLE L1 can be set to disable for LPT-LP Ax stepping to workaround USB3 hot plug will fail after 1 hot plug removal.

BTCG

This item allows users to enable or disable trunk clock gating.

USB Ports Per-Port Disable Control

This item allows users to enable or disable USB Ports Per-Port Disable Control. Control each of the USB ports (0~13) disabling

3.4.2.3 PCH Azalia Configuration

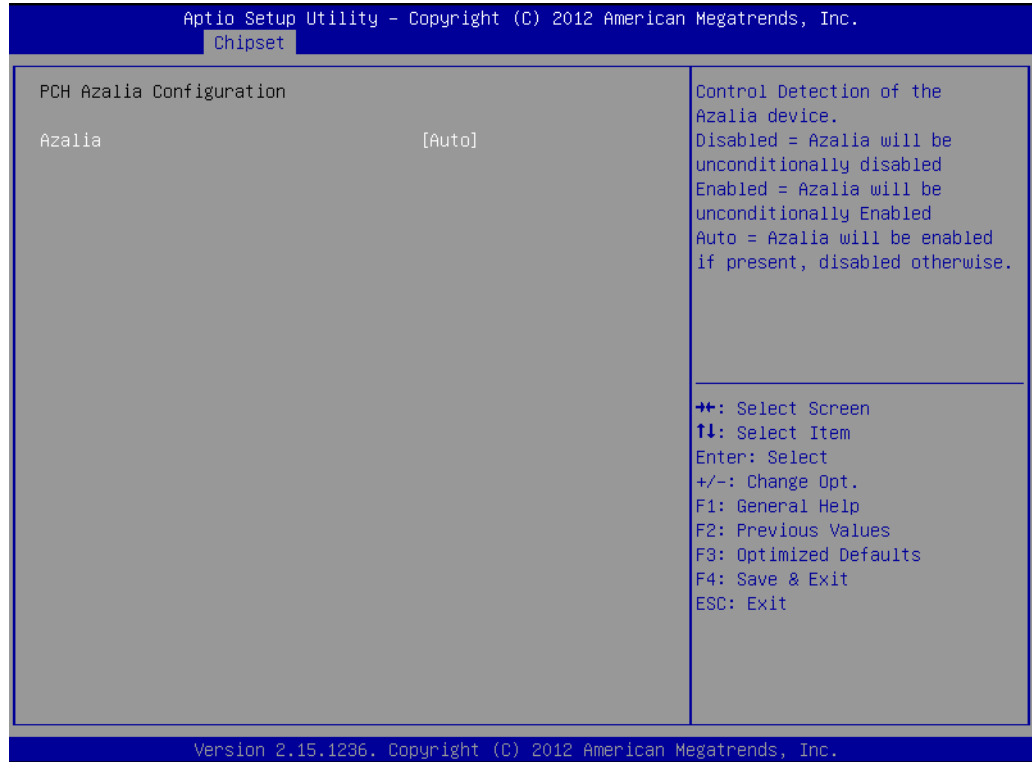

Figure 3.26 PCH Azalia Configuration

Azalia

This item allows users to change Azalia settings.

Control detection of the Azalia device.

Disable- Azalia will be unconditionally Disabled

Enabled- Azalia will be unconditionally Enabled

Auto- Azalia will be enabled if present, disabled otherwise.

3.5 Boot Settings



Figure 3.27 Boot Setup Utility

Setup Prompt Timeout

This item allows users to select the number of seconds to wait for setup activation key.

Bootup NumLock State

Select the Power-on state for Numlock.

Quiet Boot

If this option is set to Disabled, the BIOS displays normal POST messages. If Enabled, an OEM Logo is shown instead of POST messages.

Boot Option #1

This item allows users to set the system boot order.

Hard Drive BBS Priorities

This item allows users to set the order of the legacy devices in this group.

CSM Support

This item allows users to enable or disable CSM support.

3.6 Security Setup

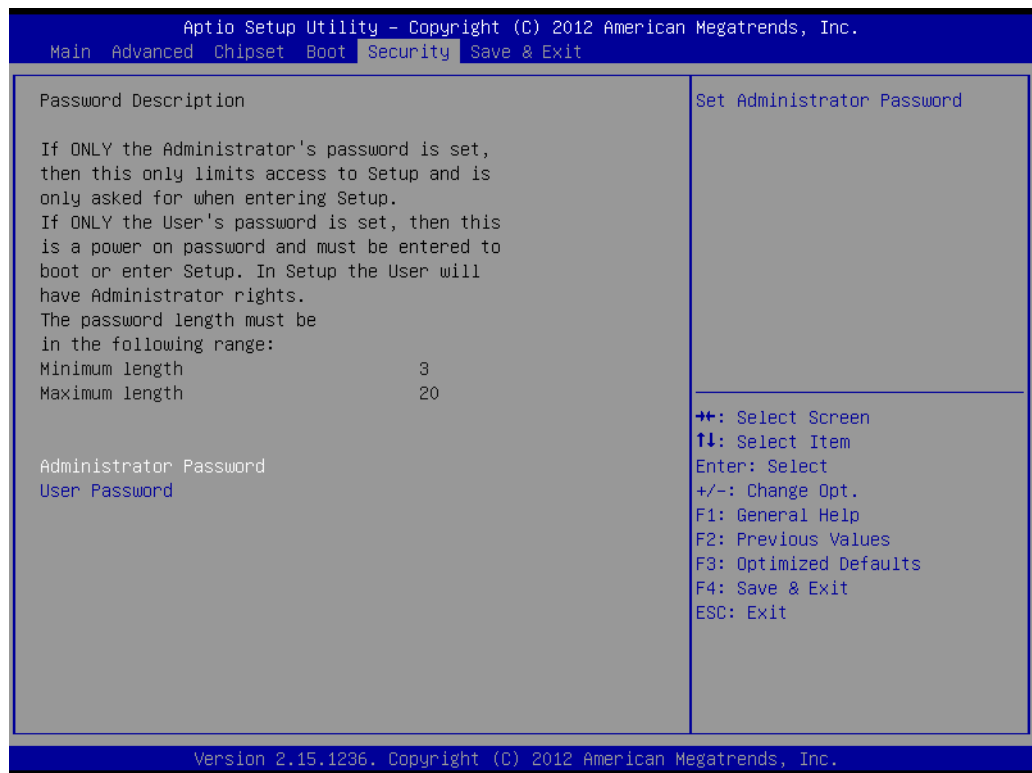

Figure 3.28 Password Configuration

Select Security Setup from the MIO-5271 Setup main BIOS setup menu. All Security Setup options, such as password protection and virus protection are described in this section. To access the sub menu for the following items, select the item and press <Enter>:

Change Administrator / User Password: Select this option and press <ENTER> to access the sub menu, and then type in the password.

3.7 Save & Exit

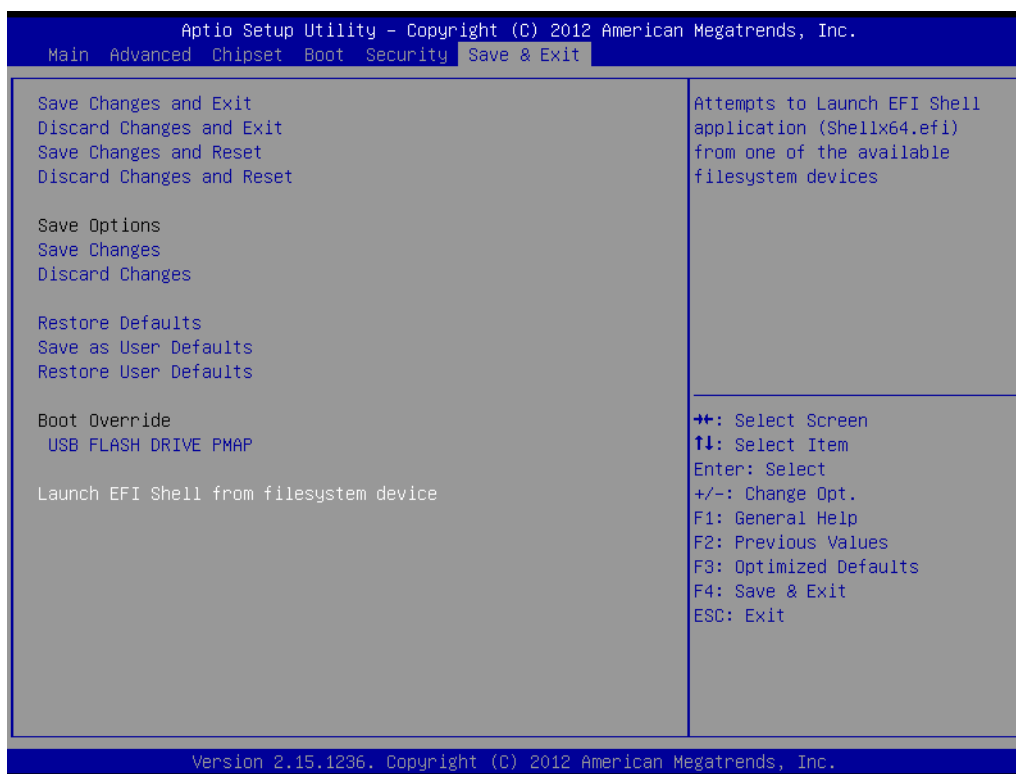

Figure 3.29 Save & Exit

3.7.1 Save Changes and Exit

When users have completed system configuration, select this option to save changes, exit BIOS setup menu and reboot the computer if necessary to take effect all system configuration parameters.

3.7.2 Discard Changes and Exit

Select this option to quit Setup without making any permanent changes to the system configuration.

3.7.2.1 Save Changes and Reset

When users have completed system configuration, select this option to save changes, exit BIOS setup menu and reboot the computer to take effect all system configuration parameters.

3.7.3 Discard Changes and Reset

Select this option to quit Setup without making any permanent changes to the system configuration and reboot the computer.

3.7.4 Save Changes

When users have completed system configuration, select this option to save changes without exit BIOS setup menu.

3.7.5 Discard Changes

Select this option to discard any current changes and load previous system configuration.

3.7.6 Restore Defaults

The MIO-5271 automatically configures all setup items to optimal settings when users select this option. Optimal Defaults are designed for maximum system performance, but may not work best for all computer applications. In particular, do not use the Optimal Defaults if the user's computer is experiencing system configuration problems.

3.7.7 Save as User Defaults

When users have completed system configuration, select this option to save changes as user defaults without exit BIOS setup menu.

3.7.8 Restore User Defaults

The users can select this option to restore user defaults.

3.7.9 Boot Override

This item allows users to choose boot device.

Chapter 4

MIOe Installation

The MI/O compact form factor SBC is a new-generation SBC design with a variety of mechanical improvements. Here is the quick installation guide for our thermal design and MIOe module installation.

4.1 Quick Installation Guide:

1. There is a Heatsink / Cooler in the white box inside the package. Carefully remove the release paper from the thermal pad before installation.

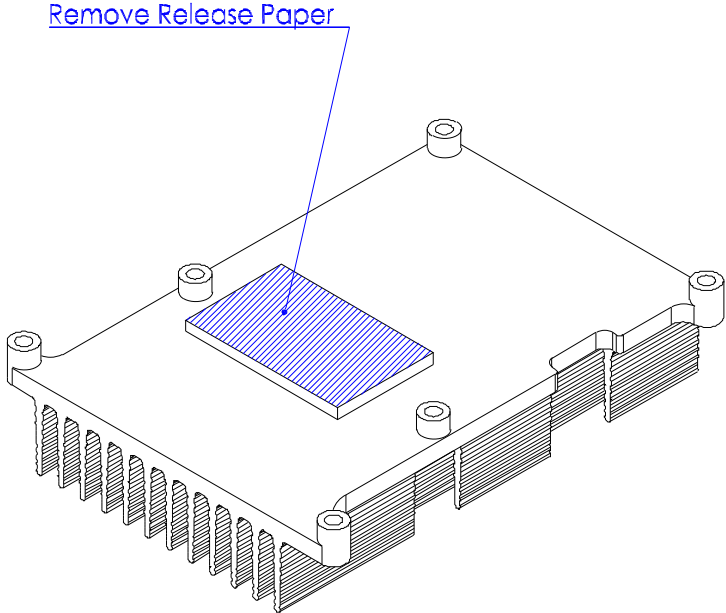

2. There are eight screws, six studs and two nuts inside the white box, please install the heatsink into place as per illustration below:

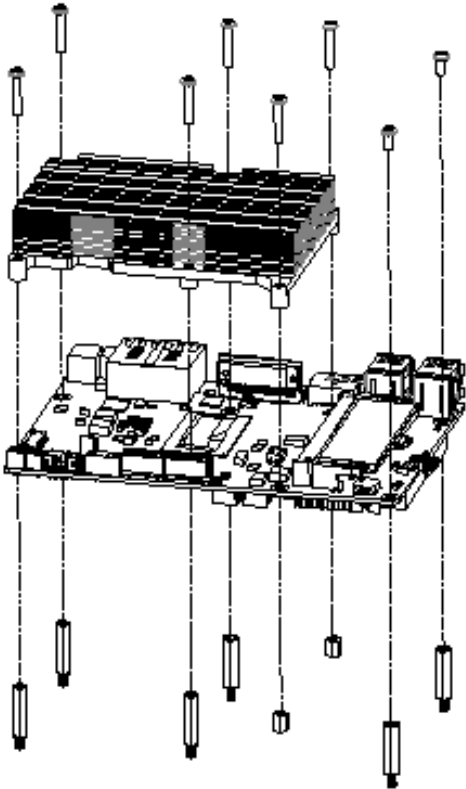

Appendix **A**

Pin Assignments

This appendix contains information of a detailed or specialized nature.

Sections include:

- Jumper and Connector Tables

A.1 Jumper and Connector Tables

J2	Auto Power On Setting
Part Number	1653002101
Footprint	HD_2x1P_79_D
Description	PIN HEADER 2*1P 180D(M)SQUARE 2.0mm DIP W/O Pb
Setting	Function
NC	Power Button for Power On

J3	LCD Power
Part Number	1653003201
Footprint	HD_3x2P_79_D
Description	PIN HEADER 3*2P 180D(M) 2.0mm DIP SQUARE WO/Pb
Setting	Function
(1-3)*	+3.3V
(3-5)	+5V
(3-4)	+12V

SW2	mPCIE mSATA selection
Part Number	1600003089-01
Footprint	SW_2x2P_100_198x378
Description	DIP SW ESD102LTZ SMD 2x2P 5.04X6.6X3.1mm
Setting	Function
(1-2)*	mSATA
(3-4)	mPCle
(2-4)	Auto detect

SW3	Clear CMOS
Part Number	1600000071
Footprint	SW_3P_CJS-1201TA1
Description	DIP SW CJS-1201TA1 SMD 3P SPDT P=6.0mm W=2.5mm
Setting	Function
(2->1)*	normal
(2->3)	Clear CMOS (RTC RST#)

CN1	12V Power Input
Part Number	1655003865
Footprint	WF_2x2P_165_BOX_RA_D_740SP
Description	ATX PWRCONN 2x2P 4.2mm 90D(M) DIP 740-77-04TS50
Pin	Pin Name
1	GND
2	GND
3	+12V
4	+12V

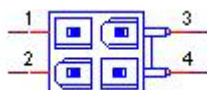

CN5	Power Switch
Part Number	1655302020
Footprint	WF_2P_79_BOX_R1_D
Description	WAFER BOX 2P 2.0mm 180D(M) DIP A2001WV2-2P
Pin	Pin Name
1	PSIN
2	GND



CN7	Reset
Part Number	1655302020
Footprint	WF_2P_79_BOX_R1_D
Description	WAFER BOX 2P 2.0mm 180D(M) DIP A2001WV2-2P
Pin	Pin Name
1	RESET#
2	GND



CN8	GPIO
Part Number	1653004099
Footprint	HD_5x2P_79_23N685B-10M10
Description	BOX HEADER 5x2P 2.00mm 180D(M) SMD 23N685B-10M10
Pin	Pin Name
1	+5V
2	GPIO4
3	GPIO0
4	GPIO5
5	GPIO1
6	GPIO6
7	GPIO2
8	GPIO7
9	GPIO3
10	GND

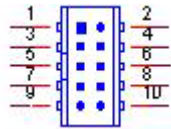

CN9	VGA
Part Number	1654000055
Footprint	DBVGA-VF5MS
Description	D-SUB Conn. 15P 90D(F) DIP 070242FR015S200ZU
Pin	Pin Name
1	RED
2	GREEN
3	BLUE
4	NC
5	GND
6	GND
7	GND
8	GND
9	5V
10	GND
11	NC
12	DDAT
13	HSYNC
14	VSYNC
15	DCLK

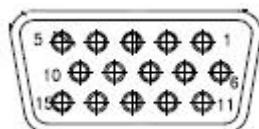

CN10	DP/HDMI
Part Number	1654010203
Footprint	HDMICON_21P_845-002-217CRL
Description	
Pin	Pin Name
1	ML_Lane0(p)/TMDS Data2+
2	GND/TMDS Data2 Shield
3	ML_Lane0(n)/TMDS Data2-
4	ML_Lane1(p)/TMDS Data1+
5	GND/TMDS Data1 Shield
6	ML_Lane1(n)/TMDS Data1-
7	ML_Lane2(p)/TMDS Data0+
8	GND/TMDS Data0 Shield
9	ML_Lane2(n)/TMDS Data0-
10	ML_Lane3(p)/TMDS Clock+
11	GND/TMDS Clock Shield
12	ML_Lane3(n)/TMDS Clock-
13	NC
14	NC
15	AUX CH(p)/SCL
16	GND/SDA
17	AUX CH(n)/DDC Ground
18	Hot Plug Detect/+5V Power
19	GND/Hot Plug Detect
20	+3.3V

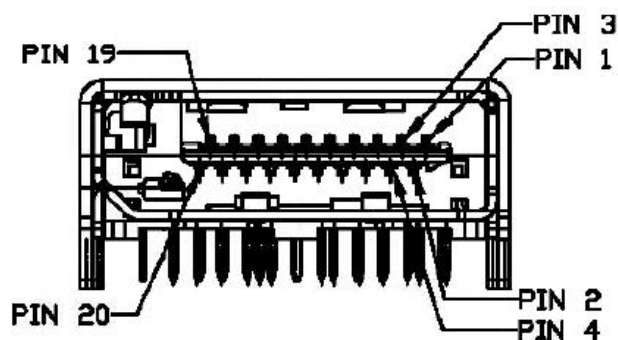

CN11	SATA
Part Number	1654007578
Footprint	SATA_7P_WATF-07DBN6SB1U
Description	Serial ATA 7P 1.27mm 180D(M) SMD WATF-07DBN6SB1U
Pin	Pin Name
1	GND
2	TX+
3	TX-
4	GND
5	RX-
6	RX+
7	GND

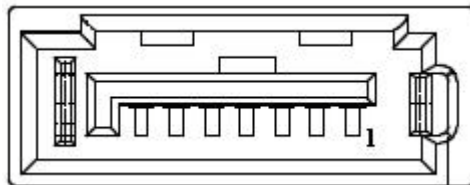

CN12	SATA
Part Number	1654007578
Footprint	SATA_7P_WATF-07DBN6SB1U
Description	Serial ATA 7P 1.27mm 180D(M) SMD WATF-07DBN6SB1U
Pin	Pin Name
1	GND
2	TX+
3	TX-
4	GND
5	RX-
6	RX+
7	GND

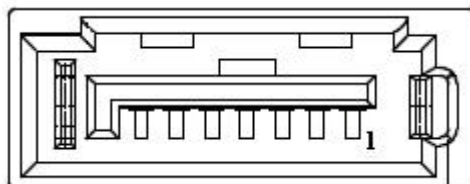

CN13	SATA Power
Part Number	1655001154
Footprint	WF_4P_98_BOX_R1_D
Description	WAFER BOX 4P 2.50mm 180D(M) DIP 24W1170-04S10-01
Pin	Pin Name
1	+5V
2	GND
3	GND
4	+12V



CN14	Mini PCIE
Part Number	1654002538
Footprint	MINIPICIE_HALF_PICO_ITX
Description	MINI PCI E 52P 6.8mm 90D SMD AS0B226-S68N7H
Pin	Pin Name
1	WAKE#
2	+3.3VSB
3	NC
4	GND
5	NC
6	+1.5V
7	CLK_MIN1_z_REQ#
8	+VUIM_PWR
9	GND
10	UIM_DATA
11	REFCLK-
12	UIM_CLK
13	REFCLK+
14	UIM_RESET
15	GND
16	+VUM_VPP
17	NC
18	GND
19	NC
20	W_DISABLE#
21	GND
22	PERST#
23	PERn0
24	+3.3VSB

25	PERp0
26	GND
27	GND
28	+1.5V
29	GND
30	SMB_CLK
31	PETn0
32	SMB_DATA
33	PETp0
34	GND
35	GND
36	USB D-
37	GND
38	USB D+
39	+3.3VSB
40	GND
41	+3.3VSB
42	NC
43	GND
44	NC
45	NC
46	NC
47	NC
48	+1.5V
49	NC
50	GND
51	NC
52	+3.3VSB

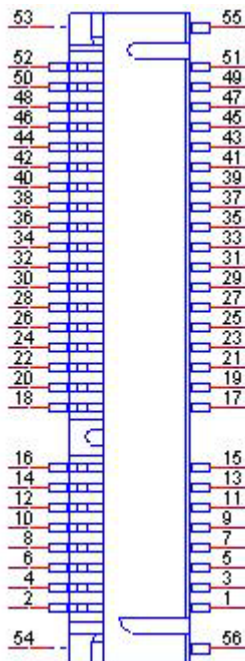

CN15	SIM
Part Number	1654010809-01
Footprint	SIM_6P_5210622-SINR03
Description	
Pin	Pin Name
C1	UIM_PWR
C2	UIM_RESET
C3	UIM_CLK
C5	GND
C6	UIM_VPP
C7	UIM_DATA

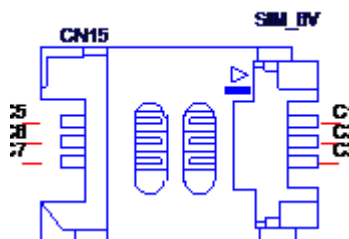

CN16	External USB2.0+USB3.0
Part Number	1654010199
Footprint	USB_13P_UEA1112C-UHS6-4F
Description	
Pin	Pin Name
1	+5V
2	D-
3	D+
4	GND
5	SSRX-
6	SSRX+
7	GND
8	SSTX-
9	SSTX+
10	+5V
11	D-
12	D+
13	GND

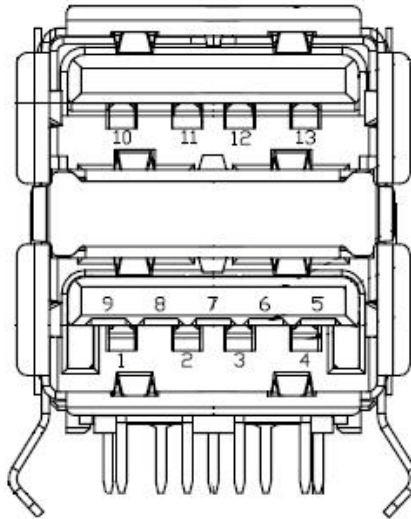

CN17	External USB2.0+USB3.0
Part Number	1654010199
Footprint	USB_13P_UEA1112C-UHS6-4F
Description	
Pin	Pin Name
1	+5V
2	D-
3	D+
4	GND
5	SSRX-
6	SSRX+
7	GND
8	SSTX-
9	SSTX+
10	+5V
11	D-
12	D+
13	GND

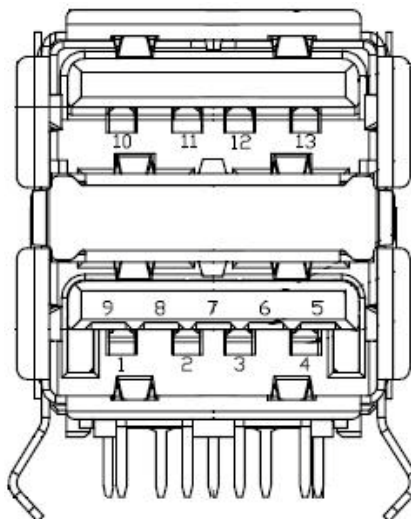

CN18	COM1/COM2
Part Number	1653004793
Footprint	HD_10x2P_79_23N685B-20M10
Description	BOX HEADER 10x2P 2.0mm 180D(M)SMD 23N685B-20M10B
Pin	Pin Name
1	DCD1#
2	DSR1#
3	RXD1
4	RTS1#
5	TXD1
6	CTS1#
7	DTR1#
8	RI1#
9	GND
10	GND
11	DCD2#
12	DSR2#
13	RXD2
14	RTS2#
15	TXD2
16	CTS2#
17	DTR2#
18	RI2#
19	GND
20	GND

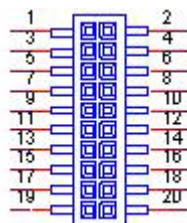

Matching Cable: 1701200220

CN19	COM3/COM4/RS422/RS485
Part Number	1653004793
Footprint	HD_10x2P_79_23N685B-20M10
Description	BOX HEADER 10x2P 2.0mm 180D(M)SMD 23N685B-20M10B
Pin	Pin Name
1	COM3_485-422_TXN-DCD#
2	COM3_z_DSR#
3	COM3_485-422_TXP-RXD
4	COM3_z_RTS#
5	COM3_422__RXP-TXD
6	COM3_z_CTS#
7	COM3_422__RXN-DTR#
8	COM3_z_RI#
9	GND
10	GND
11	COM4_485-422_TXN-DCD#
12	COM4_z_DSR#
13	COM4_485-422_TXP-RXD
14	COM4_z_RTS#
15	COM4_422__RXP-TXD
16	COM4_z_CTS#
17	COM4_422__RXN-DTR#
18	COM4_z_RI#
19	GND
20	GND

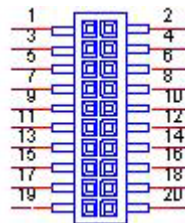

CN21	LAN
Part Number	1652003274
Footprint	RJ45_28P_RTB-19GB9J1A
Description	PHONE JACK RJ45 28P DIP RTB-19GB9J1A
Pin	Pin Name
A1	LAN1_MDI0+
A2	LAN1_MDI0-
A3	LAN1_MDI1+
A4	LAN1_MDI1-
A5	LAN1CONN
A6	LAN1_GND
A7	LAN1_MDI2+
A8	LAN1_MDI2-
A9	LAN1_MDI3+
A10	LAN1_MDI3-
A11	LAN1_ACT#
A12	LAN1_a_ACT#
B1	LAN2_MDI0+
B2	LAN2_MDI0-
B3	LAN2_MDI1+
B4	LAN2_MDI1-
B5	LAN2CONN
B6	LAN2_GND
B7	LAN2_MDI2+
B8	LAN2_MDI2-
B9	LAN2_MDI3+
B10	LAN2_MDI3-
B11	LAN2_ACT#
B12	LAN2_a_ACT#

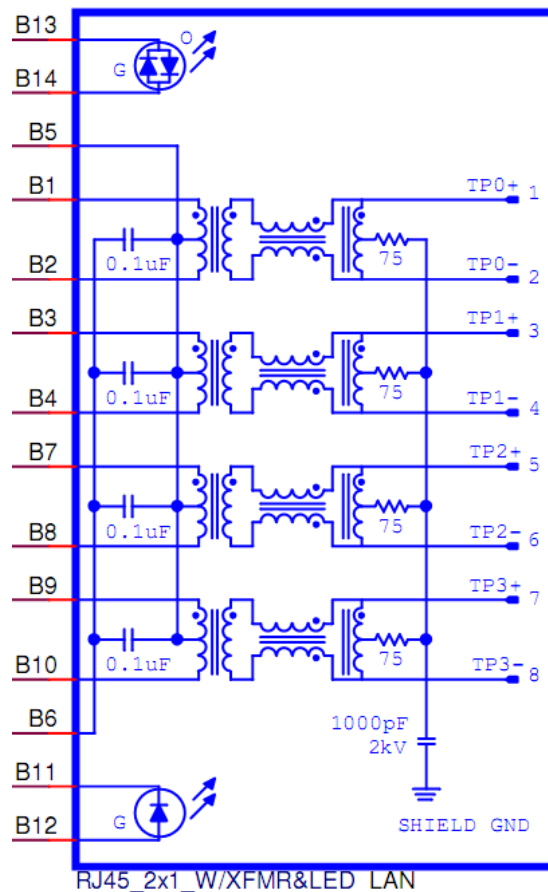
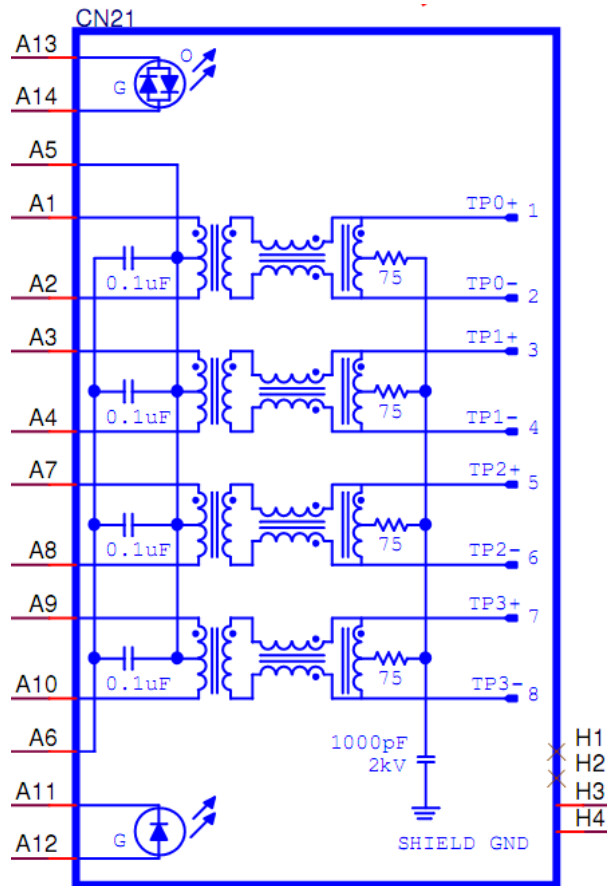

CN23	Audio
Part Number	1653004099
Footprint	HD_5x2P_79_23N685B-10M10
Description	BOX HEADER 5x2P 2.00mm 180D(M) SMD 23N685B-10M10
Pin	Pin Name
1	LOUTR
2	LINR
3	GND
4	GND
5	LOUTL
6	LINL
7	GND
8	GND
9	MIC1R
10	MIC1L

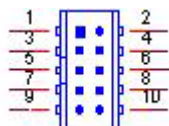

Matching Cable: 1703100152

CN24	MIOe
Part Number	1654006235
Footprint	BB_40x2P_32_1625x285_2HOLD
Description	B/B Conn. 40x2P 0.8mm 180D(F) SMD QSE-040-01-L-D
Pin	Pin Name
1	GND
2	GND
3	PCIE_RX0+
4	PCIE_TX0+
5	PCIE_RX0-
6	PCIE_TX0-
7	GND
8	GND
9	NC
10	NC
11	NC
12	NC
13	GND
14	GND
15	NC
16	NC
17	NC
18	NC
19	GND

20	GND
21	NC
22	NC
23	NC
24	NC
25	GND
26	GND
27	PCIE_CLK+
28	LOUTL
29	PCIE_CLK-
30	LOUTR
31	GND
32	AGND
33	SMB_STB_CLK
34	NC
35	SMB_STB_DAT
36	NC
37	PCIE_WAKE#
38	NC
39	RESET#
40	NC
41	PowerOn
42	CLK33M
43	NC
44	LPC_AD0
45	DDP_HPD
46	LPC_AD1
47	GND
48	LPC_AD2
49	DDP_AUX+
50	LPC_AD3
51	DDP_AUX-
52	NC
53	GND
54	LPC_SERIRQ
55	DDP_D0+
56	LPC_FRAME#
57	DDP_D0-
58	GND
59	GND
60	USB0_D+
61	DDP_D1+
62	USB0_D-
63	DDP_D1-
64	GND
65	GND
66	USB1_D+
67	DDP_D2+

68	USB1_D-
69	DDP_D2-
70	GND
71	GND
72	USB2_D+
73	DDP_D3+
74	USB2_D-
75	DDP_D3-
76	GND
77	GND
78	USB_OC#
79	+12VSB
80	+12VSB
83	GND
84	GND
85	GND
86	GND
87	+5VSB
88	+5VSB
89	+5VSB
90	+5VSB

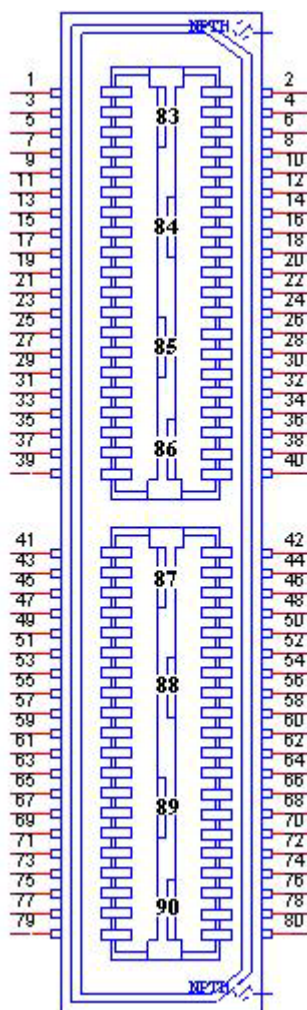

CN25	Inverter Power Output
Part Number	1655000453
Footprint	WHL5V-2M-24W1140
Description	WAFER BOX 2.0mm 5P 180D(M) DIP WO/Pb JIH VEI
Pin	Pin Name
1	+12V
2	GND
3	ENABKL
4	PWM
5	+5V

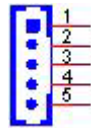

CN26	48 bits LVDS Panel
Part Number	1653920200
Footprint	SPH20X2
Description	B/B Conn. 40P 1.25mm 90D SMD DF13-40DP-1.25V(91)
Pin	Pin Name
1	+V_LCD
2	+V_LCD
3	GND
4	GND
5	+V_LCD
6	+V_LCD
7	LVDS0_D0-
8	LVDS1_D0-
9	LVDS0_D0+
10	LVDS1_D0+
11	GND
12	GND
13	LVDS0_D1-
14	LVDS1_D1-
15	LVDS0_D1+
16	LVDS1_D1+
17	GND
18	GND
19	LVDS0_D2-
20	LVDS1_D2-
21	LVDS0_D2+
22	LVDS1_D2+
23	GND
24	GND
25	LVDS0_CLK-

26	LVDS1_CLK-
27	LVDS0_CLK+
28	LVDS1_CLK+
29	GND
30	GND
31	NC
32	NC
33	GND
34	GND
35	LVDS0_D3-
36	LVDS1_D3-
37	LVDS0_D3+
38	LVDS1_D3+
39	NC
40	NC



CN29	SMBus
Part Number	1655904020
Footprint	FPC4V-125M
Description	WAFER 4P 1.25mm 180D(M) SMD 85205-04001
Pin	Pin Name
1	GND
2	SMB_DAT
3	SMB_CLK
4	+5V

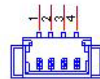

CN31	Mini PCIE
Part Number	1654002538
Footprint	MINIPCIE_HALF_PICO2600
Description	MINI PCI E 52P 6.8mm 90D SMD AS0B226-S68N7H
Pin	Pin Name
1	WAKE#
2	+3.3VSB
3	NC
4	GND
5	NC
6	+1.5V
7	NC
8	NC
9	GND
10	NC
11	REFCLK-
12	NC
13	REFCLK+
14	NC
15	GND
16	NC
17	NC
18	GND
19	NC
20	W_DISABLE#
21	GND
22	PERST#
23	PERn0
24	+3.3VSB
25	PERp0
26	GND
27	GND

28	+1.5V
29	GND
30	SMB_CLK
31	PETn0
32	SMB_DAT
33	PETp0
34	GND
35	GND
36	USB D-
37	GND
38	USB D+
39	+3.3VSB
40	GND
41	+3.3VSB
42	NC
43	GND
44	NC
45	NC
46	NC
47	NC
48	+1.5V
49	NC
50	GND
51	NC
52	+3.3VSB

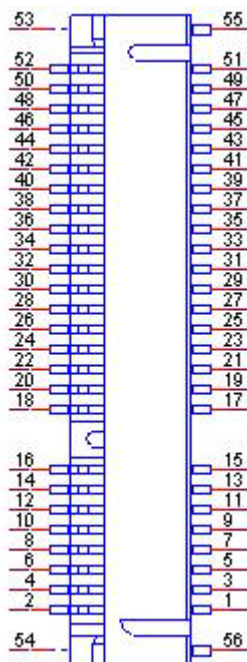

FAN1	System FAN
Part Number	1655003010
Footprint	WHP3VA
Description	
Pin	Pin Name
1	GND
2	+V12
3	N/C

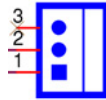

Appendix **B**

System Assignments

This appendix contains information of a detailed nature.

Sections include:

- System I/O Ports
- DMA Channel Assignments
- 1st MB Memory Map
- Interrupt Assignments

B.1 System I/O Ports

Table B.1: System I/O Ports

Addr. Range (Hex)	Device
00-1F	DMA Controller
20-2D	Interrupt Controller
50-52	Timer/Counter
60-6F	8042 (keyboard controller)
70-7F	Real-time clock, non-maskable interrupt (NMI) mask
80-9F	DMA page register
A0-BF	Motherboard resources
C0-DF	DMA controller
299-29A	EC HM Index port and Data port
29C-29D	EC Index port and Data port
2E8-2EF	Communications Port (COM4)
2F8-2FF	Communications Port (COM2)
3C0-3DF	Motherboard resources
3E8-3EF	Communications Port (COM3)
3F8-3FF	Communications Port (COM1)
4D0-4D1	Motherboard resources

B.2 DMA Channel assignments

Table B.2: DMA Channel assignments

Channel	Function
0	Available
1	Available
2	Available
3	Available
4	Direct memory access controller
5	Available
6	Available
7	Available

B.3 1st MB memory map

Table B.3: 1st MB memory map

Addr. Range (Hex)	Device
E0000h - FFFFFh	System board
D0000h - DFFFFh	PCI Bus
C0000h - CFFFFh	System board
A0000h - BFFFFh	PCI Bus
A0000h - BFFFFh	Intel® HD Graphic
00000h - 9FFFFh	System board

B.4 Interrupt assignments

Table B.4: Interrupt assignments

Interrupt#	Interrupt source
NMI	Parity error detected
IRQ0	System timer
IRQ1	Standard 101/102-Key or Microsoft Natural PS/2 Keyboard
IRQ2	Interrupt from controller 2 (cascade)
IRQ3	Communications Port (COM2)
IRQ4	Communications Port (COM1)
IRQ5	EC Watch DOG
IRQ6	Available
IRQ7	Communications Port (COM3)
IRQ8	System CMOS/real time clock
IRQ9	Microsoft ACPI-Compliant System
IRQ10	Available
IRQ11	Communications Port (COM4)
IRQ12	PS/2 Compatible Mouse
IRQ13	Numeric data processor
IRQ14	Reserved
IRQ15	Reserved

Appendix **C**

Watchdog Timer
Sample Code

C.1 Watchdog Timer Sample Code

```
EC_Command_Port = 0x29Ah
EC_Data_Port = 0x299h
Write EC HW ram = 0x89
Watch dog event flag = 0x57
Watchdog reset delay time = 0x5E
Reset event = 0x04
Start WDT function = 0x28
Stop WDT function = 0x29
Reset WDT function = 0x2A
=====
.model small
.486p
.stack 256
.data
.code
org 100h
.STARTUp

mov dx, EC_Command_Port
mov al,89h          ; Write EC HW ram.
out dx,al

mov dx, EC_Data_Port
mov al, 5Eh        ; Watchdog reset delay time high byte index.
out dx,al

mov dx, EC_Data_Port
mov al, 00h        ;Set 0 seconds delay time.
out dx,al

mov dx, EC_Data_Port
mov al,5Fh         ; Watchdog reset delay time low byte index.
out dx,al

mov dx, EC_Data_Port
mov al, 30h        ; Set 3 seconds delay time.
out dx,al

mov dx, EC_Command_Port
mov al, 89h        ; Write EC HW ram.
out dx,al

mov dx, EC_Data_Port
mov al,57h         ; Watch dog event flag.
out dx,al
```

```
mov dx, EC_Data_Port
mov al, 04h      ; Reset event.
out dx,al
```

```
mov dx, EC_Command_Port
mov al,28h      ; start WDT function. (stop: 0x29, reset: 0x2A)
out dx,al
```

```
.exit
END
```

ADVANTECH

Enabling an Intelligent Planet

www.advantech.com

Please verify specifications before quoting. This guide is intended for reference purposes only.

All product specifications are subject to change without notice.

No part of this publication may be reproduced in any form or by any means, electronic, photocopying, recording or otherwise, without prior written permission of the publisher.

All brand and product names are trademarks or registered trademarks of their respective companies.

© Advantech Co., Ltd. 2014