

B450, Tantalum, MnO2 Tantalum, 22 uF, 20%, 25 V, SMD, Molded, Low ESR, Surge Robust, 200 mOhms, 7343, Height Max = 3.1mm

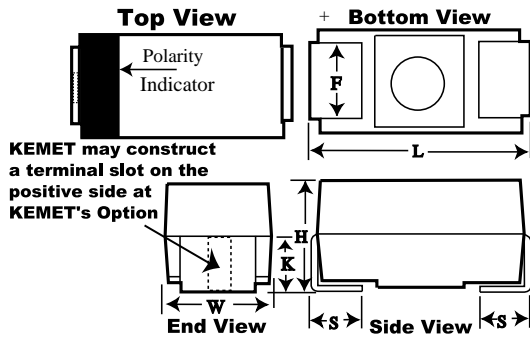

General Information	
Supplier:	KEMET
Series:	B450
Dielectric:	MnO2 Tantalum
Style:	SMD Chip
Description:	SMD, Molded, Low ESR, Surge Robust
Features:	Low ESR, Surge Robust
RoHS:	Yes
Termination:	Tin
Notes:	Obsolete. Old Part Number [Obsolete] Was B45025D2269M207

Dimensions	
Footprint	7343
L	7.3mm +/-0.3mm
W	4.3mm +/-0.3mm
H	2.8mm +/-0.3mm
S	1.3mm +/-0.3mm
F	2.4mm +/-0.1mm
K	1.8mm TYP

Packaging Specifications	
Packaging:	T&R, 178mm
Packaging Quantity:	750

Specifications	
Capacitance:	22 uF
Capacitance Tolerance:	20%
Voltage DC:	25 VDC (85C), 16.75 VDC (125C)
Temperature Range:	-55/+125C
Rated Temperature:	85C
Dissipation Factor:	6%
Failure Rate:	N/A
Resistance:	0.2 Ohms (100kHz)
Current:	870 mAmps (25C), 783 mAmps (85C), 348 mAmps (125C)
Leakage Current:	5.5 uA