

DESCRIPTION: POWER / SIGNAL - RIGHT ANGLE - MALE - IP67

**SPECIFICATIONS:**

**ELECTRICAL:**  
 INSULATOR RESISTANCE: 5 G OHMS Min.  
 DIELECTRIC WITHSTANDING: 1,000VAC r.m.s.  
 OPERATING TEMPERATURE: -55° C ~ +125° C  
 POWER CONTACT RESISTANCE: 1.0 Milliohms Max.  
 SIGNAL CONTACT RESISTANCE: 2.7 Milliohms Max.  
 POWER PINS: 40 AMPS  
 SIGNAL PINS: 5 AMPS

**MECHANICAL:**  
 CONTACT INSERTION FORCE: 4.5 Kg Max.  
 CONTACT SEPARATOR FORCE: 0.3Kg Min.

**MATERIALS:**  
 CONTACTS: COPPER ALLOY  
 INSULATOR: PBT THERMOPLASTIC, 30% GLASS FILLED, UL94V-0 RATED, BLACK 230°C PROCESS TEMP.  
 SHELL: STEEL  
 BOARD LOCK: BRASS, NICKEL PLATED  
 CINCHNUT: BRASS, NICKEL PLATED  
 BRACKET: STEEL, NICKEL PLATED  
 SEAL: F08 FLEXIBLE ADHESIVE

**FINISH:**  
 SHELL: NICKEL  
 CONTACTS: FULL GOLD FLASH

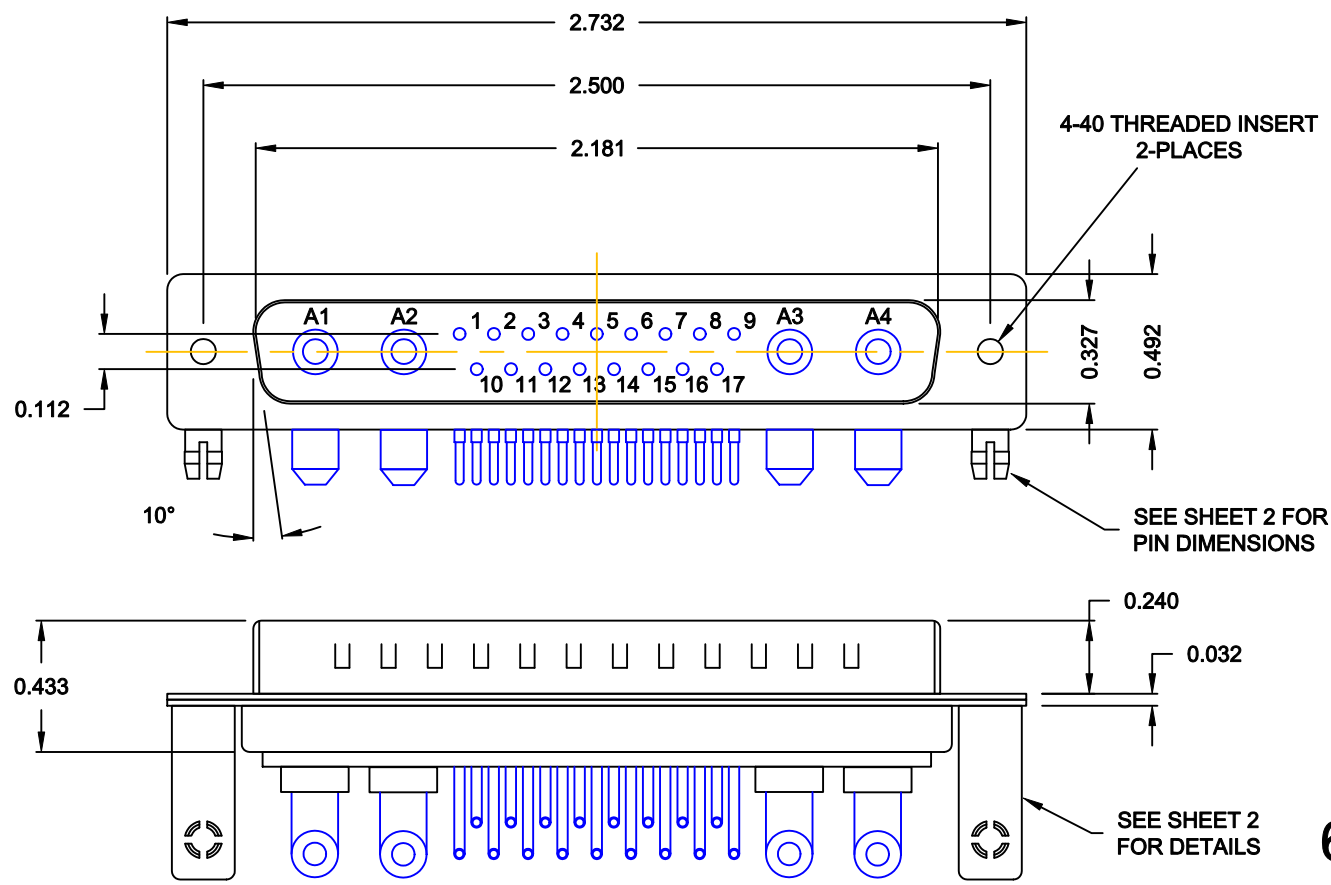

**684S21WA4PL461**

46 = 4-40 INSERTS / BOARD LOCKS

**RoHS COMPLIANT**

**MEETS IP67 STANDARDS**  
 (SEE PAGE 3 FOR SEALING DETAILS)

	THESE DRAWINGS AND SPECIFICATIONS ARE THE PROPERTY OF NorComp AND SHALL NOT BE REPRODUCED, COPIED OR USED AS THE BASIS FOR THE MANUFACTURE OR SALE OF APPARATUS WITHOUT WRITTEN PERMISSION.		DRAWN: <b>M. SIGMON</b>	DATE: <b>06-12-13</b>
				CHECKED:
<h1>NorComp</h1>	SCALE: <b>1.5 = 1</b>	SHEET <b>1</b> OF <b>3</b>	REV <b>0</b>	
	DWG NO. <b>684S21WA4PL461</b>			

NOTE:  
POWER CONTACTS COME  
PRE-LOADED INTO INSULATORS

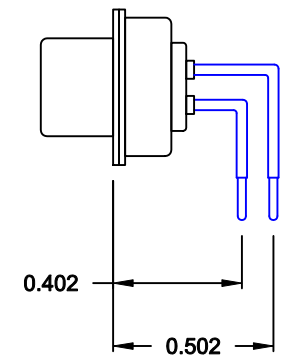
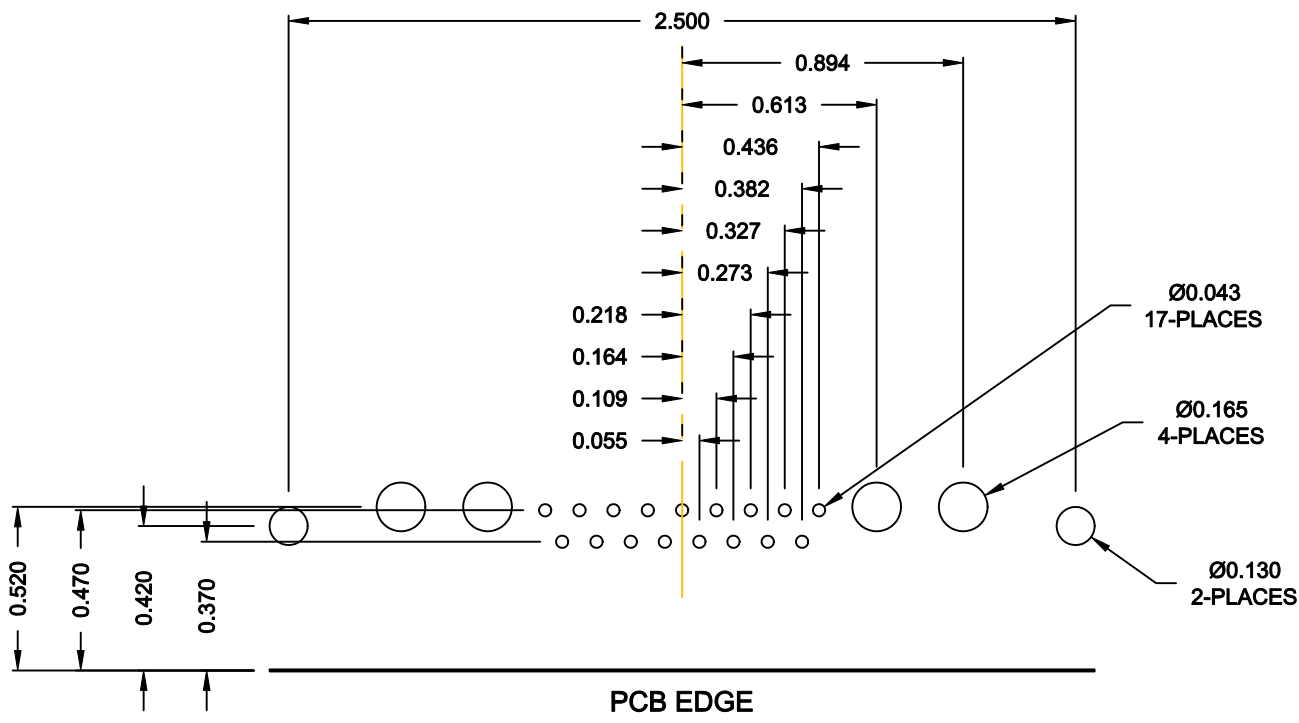

SIGNAL CONTACTS

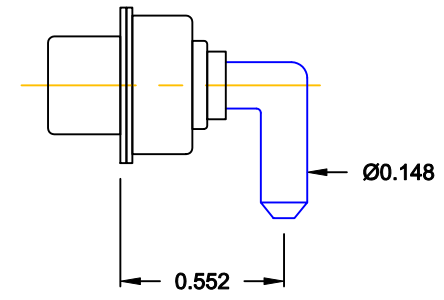

40 AMP POWER CONTACT

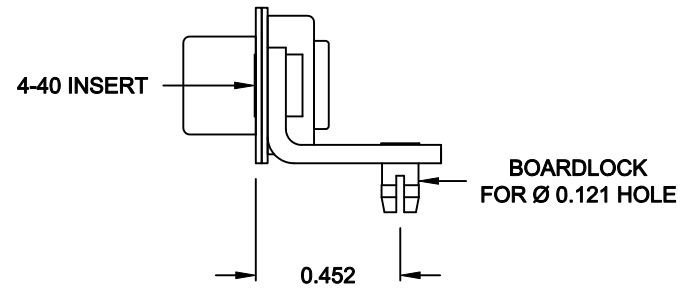

MOUNTING HARDWARE

RoHS COMPLIANT

	THESE DRAWINGS AND SPECIFICATIONS ARE THE PROPERTY OF NorComp AND SHALL NOT BE REPRODUCED, COPIED OR USED AS THE BASIS FOR THE MANUFACTURE OR SALE OF APPARATUS WITHOUT WRITTEN PERMISSION.		DRAWN: <b>M. SIGMON</b>	DATE: <b>06-12-13</b>
			CHECKED:	DATE:
<h1>NorComp</h1>		SCALE: <b>N.T.S.</b>	SHEET <b>2</b> OF <b>3</b>	REV <b>0</b>
		DWG NO. <b>684S21WA4PL461</b>		

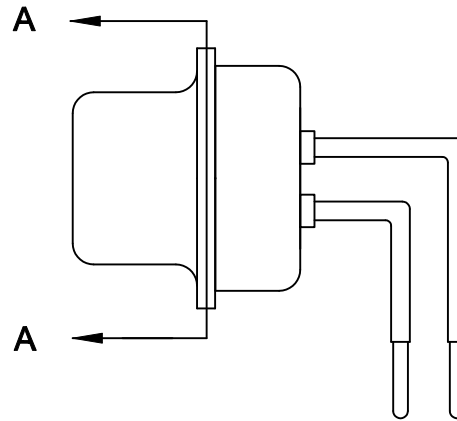

FRONT SEAL APPLIED OVER INSULATOR  
AND BETWEEN FRONT & REAR SHELLS

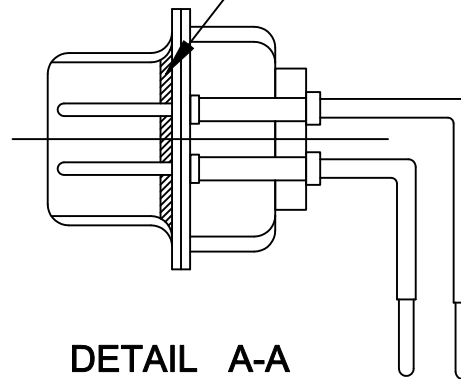

DETAIL A-A

SHOWN FOR REFERENCE ONLY

RoHS COMPLIANT

	THESE DRAWINGS AND SPECIFICATIONS ARE THE PROPERTY OF NorComp AND SHALL NOT BE REPRODUCED, COPIED OR USED AS THE BASIS FOR THE MANUFACTURE OR SALE OF APPARATUS WITHOUT WRITTEN PERMISSION.		DRAWN: <b>M. SIGMON</b>	DATE: <b>06-12-13</b>
			CHECKED:	DATE:
NorComp		SCALE: <b>1.5 = 1</b>	SHEET <b>3</b> OF <b>3</b>	REV <b>0</b>
		DWG NO. <b>684S21WA4PL461</b>		