

STRADA-2X2-CAT

Catenary street light beam optimized for EN13201 M-classes

TECHNICAL SPECIFICATIONS:

Dimensions	50.0 mm
Height	6.2 mm
Fastening	glue, pin, screw
Colour	clear
Box size	480 x 280 x 300 mm
Box weight	6.3 kg
Quantity in Box	800 pcs
ROHS compliant	yes ⓘ



MATERIAL SPECIFICATIONS:

Component	Type	Material	Colour
STRADA-2X2-CAT	Lens	PMMA	clear

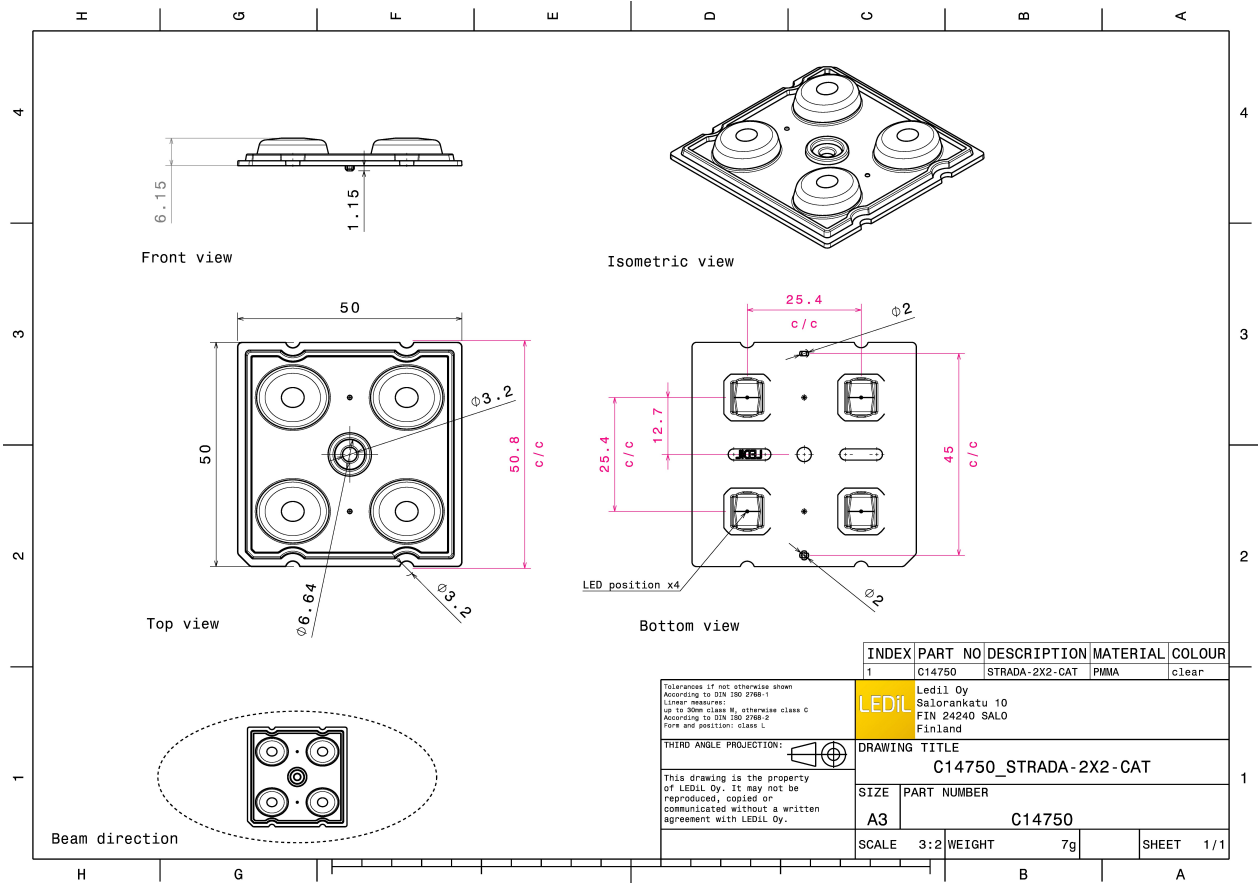

PHOTOMETRIC DATA (MEASURED):

CREE

LED XD16
FWHM 148.0 + 133.0°
Efficiency 94 %
Peak intensity 0.570 cd/lm
Required components:

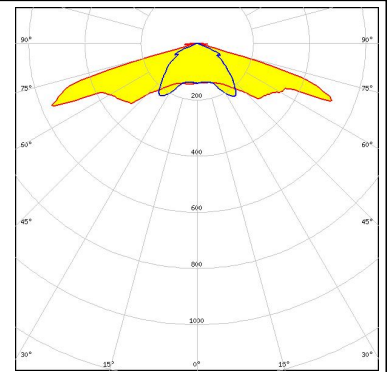

CREE

LED XD16 2x2 cluster
FWHM 150.0 + 126.0°
Efficiency 94 %
Peak intensity 0.400 cd/lm
Required components:

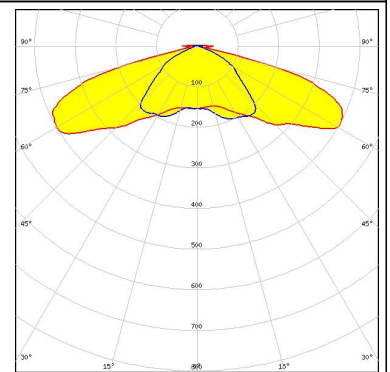

CREE

LED XP-G2
FWHM 153.0 + 118.0°
Efficiency 94 %
Peak intensity 0.380 cd/lm
Required components:

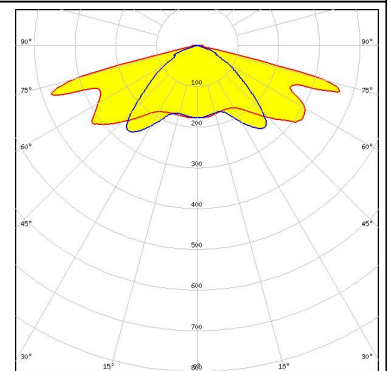

CREE

LED XP-G3
FWHM Asymmetric
Efficiency 94 %
Peak intensity 0.360 cd/lm
Required components:

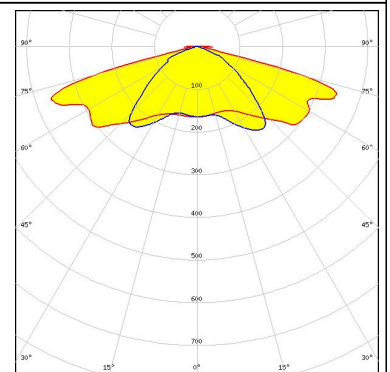

PHOTOMETRIC DATA (MEASURED):

LG Innotek

LED H35C1 (LEMWA33)
 FWHM 154.0 + 116.0°
 Efficiency 94 %
 Peak intensity 0.330 cd/lm
 Required components:

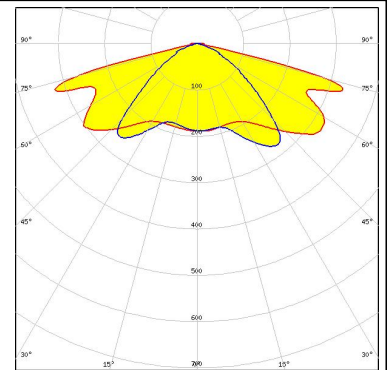

LUMILEDS

LED LUXEON 5050
 FWHM 149.0 + 119.0°
 Efficiency 94 %
 Peak intensity 0.430 cd/lm
 Required components:

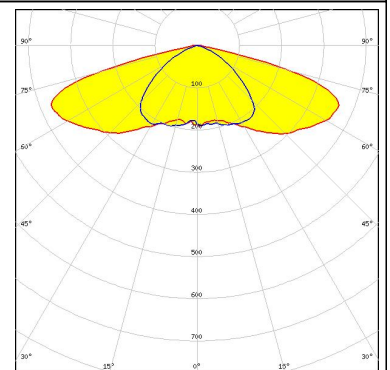

LUMILEDS

LED LUXEON V
 FWHM 152.0 + 117.0°
 Efficiency 94 %
 Peak intensity 0.330 cd/lm
 Required components:

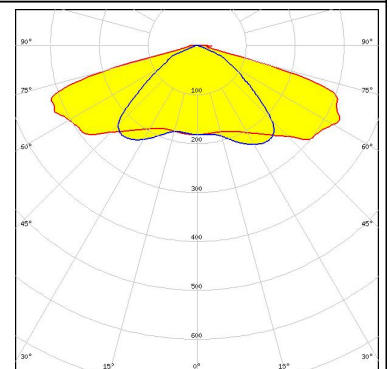
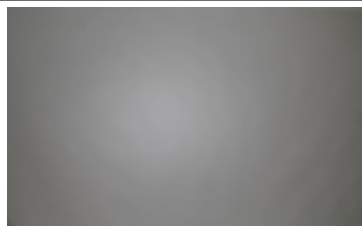

NICHIA

LED NVSW3x9A
 FWHM 152.0 + 125.0°
 Efficiency 94 %
 Peak intensity 0.490 cd/lm
 Required components:

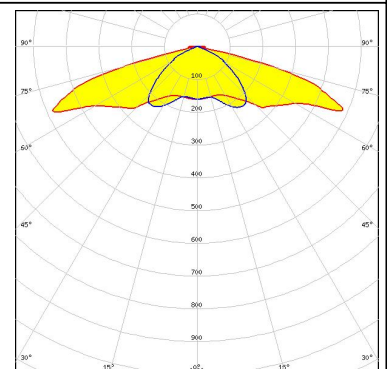
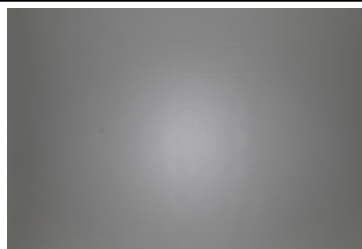

PHOTOMETRIC DATA (MEASURED):



LED NVSxE21A
 FWHM 142.0 + 130.0°
 Efficiency 94 %
 Peak intensity 0.470 cd/lm
 Required components:

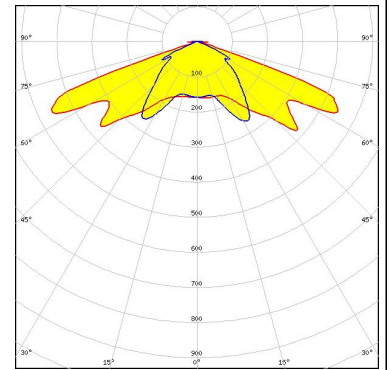

LED PrevaLED Brick DC 2x8
 FWHM 152.0 + 119.0°
 Efficiency 94 %
 Peak intensity 0.360 cd/lm
 Required components:

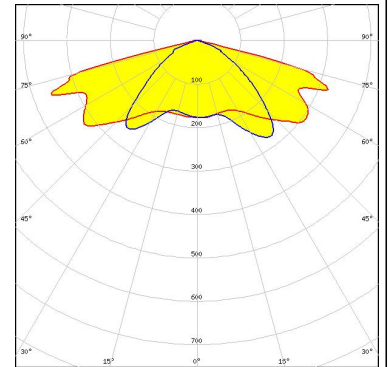

LED Oslon Square Gen3
 FWHM 152.0 + 119.0°
 Efficiency 94 %
 Peak intensity 0.360 cd/lm
 Required components:

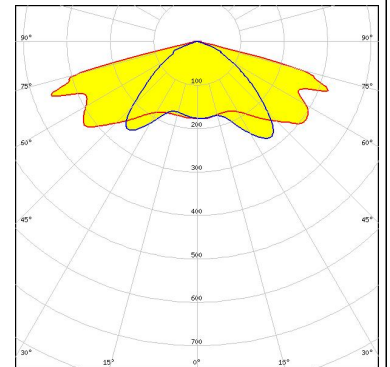

LED Fortimo FastFlex LED board 2x8 DA G4
 FWHM 117.0 + 153.0°
 Efficiency 94 %
 Peak intensity 0.500 cd/lm
 Required components:

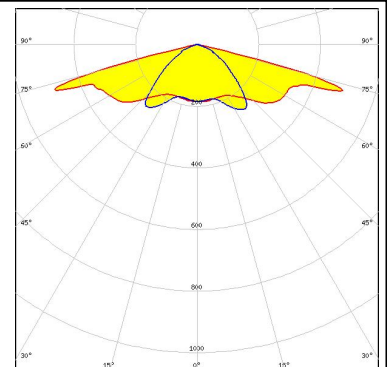

PHOTOMETRIC DATA (MEASURED):

SAMSUNG

LED LH351B
 FWHM 154.0 + 119.0°
 Efficiency 94 %
 Peak intensity 0.320 cd/lm
 Required components:

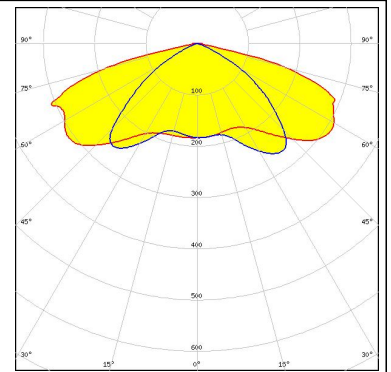

LED Z8Y22
 FWHM 143.0 + 128.0°
 Efficiency 94 %
 Peak intensity 0.520 cd/lm
 Required components:

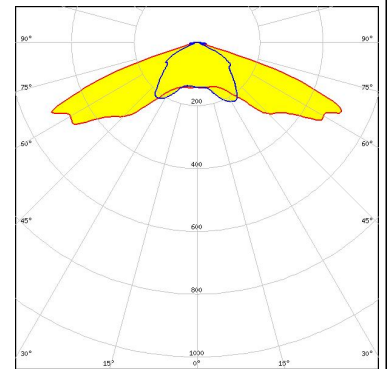

LED Z8Y22P
 FWHM 151.0 + 130.0°
 Efficiency 94 %
 Peak intensity 0.480 cd/lm
 Required components:

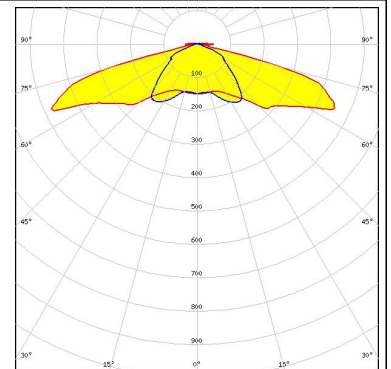

TRIDONIC

LED RLE G1 49x121mm 2000lm xxx EXC OTD
 FWHM 147.0 + 107.0°
 Efficiency 94 %
 Peak intensity 0.440 cd/lm
 Required components:

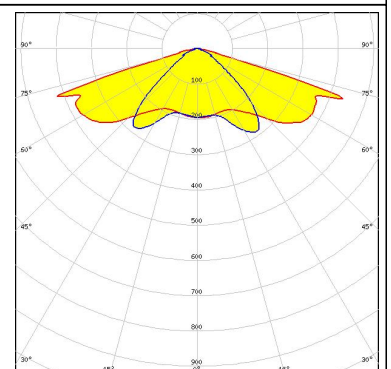

PHOTOMETRIC DATA (MEASURED):

TRIDONIC

LED RLE G1 49x133mm 2000lm xxx EXC OTD
FWHM 147.0 + 107.0°
Efficiency 94 %
Peak intensity 0.440 cd/lm
Required components:

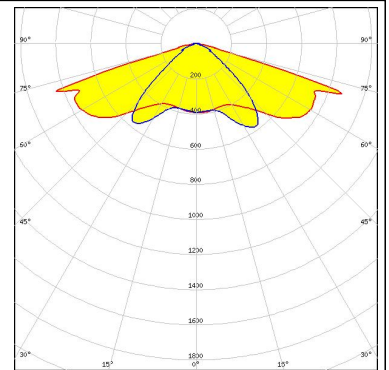

TRIDONIC

LED RLE G1 49x223mm 4000lm xxx EXC OTD
FWHM 147.0 + 107.0°
Efficiency 94 %
Peak intensity 0.440 cd/lm
Required components:

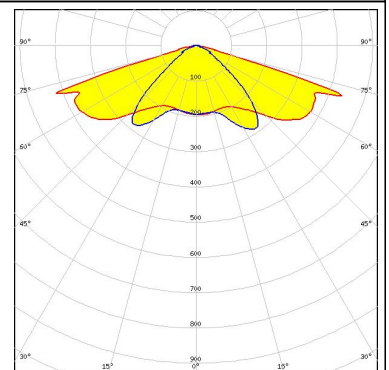

TRIDONIC

LED RLE G1 49x245mm 4000lm xxx EXC OTD
FWHM 147.0 + 107.0°
Efficiency 94 %
Peak intensity 0.440 cd/lm
Required components:

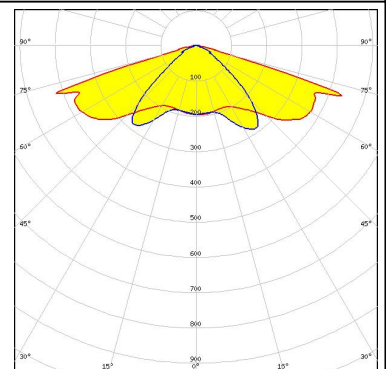

TRIDONIC

LED RLE G2 HP 2x8 4000lm
FWHM 151.0 + 119.0°
Efficiency 94 %
Peak intensity 0.600 cd/lm
Required components:

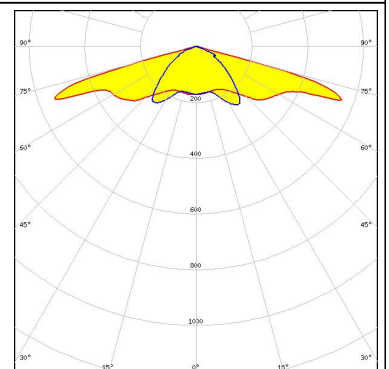

PHOTOMETRIC DATA (SIMULATED):



LED XM-L
FWHM 109.0 + 152.0°
Efficiency 93 %
Peak intensity 0.360 cd/lm
Required components:

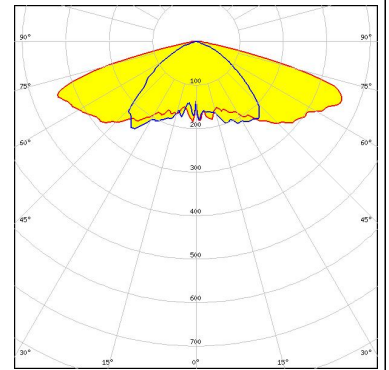

LED NVSxx19B/NVSxx19C
FWHM Asymmetric
Efficiency 92 %
Peak intensity 0.440 cd/lm
Required components:

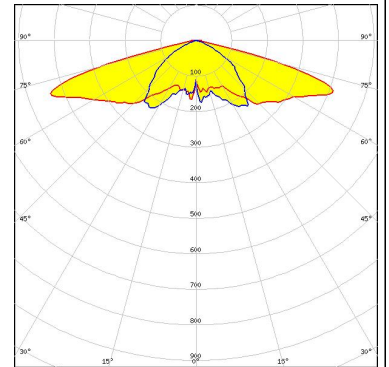

LED Duris S8
FWHM 108.0 + 151.0°
Efficiency 94 %
Peak intensity cd/lm
Required components:

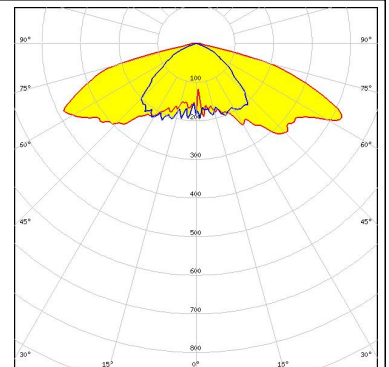

LED OSCONIQ P 3737 (3W version)
FWHM 153.0 + 92.0°
Efficiency 94 %
Peak intensity 0.370 cd/lm
Required components:

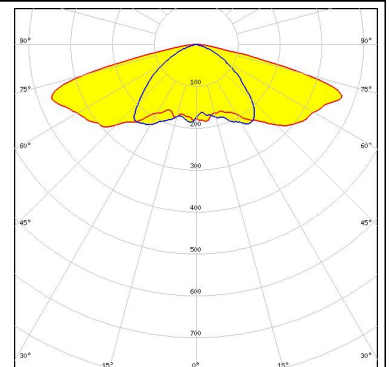

PHOTOMETRIC DATA (SIMULATED):

PHILIPS

LED Fortimo FastFlex LED board 2x8 DAX G4
FWHM 157.0 + 94.0°
Efficiency 94 %
Peak intensity 0.350 cd/lm
Required components:

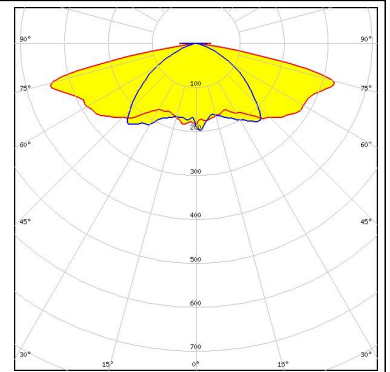

SAMSUNG

LED LH351D
FWHM 152.0 + 114.0°
Efficiency 93 %
Peak intensity 0.330 cd/lm
Required components:

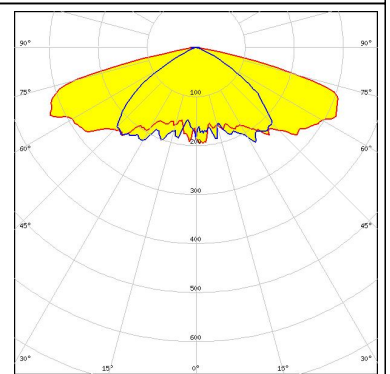

GENERAL INFORMATION:

NOTE: The typical beam angle will be changed by different color, chip size and chip position tolerance. The typical total beam angle is the full angle measured where the luminous intensity is half of the peak value.

MATERIALS:

As part of our continuous research and improvement processes, and to ensure the best possible quality and availability of our products, LEDiL reserves the right to change material grades without notice.

PRODUCT DATA USER AGREEMENT AND DISCLAIMER:

The measured data in the provided downloadable LEDiL Product Datasheets and Mechanical 2D-Drawings is rounded and provided as reference for planning. LEDiL Oy's optical specifications have been verified by conducting performance testing of the products in accordance with the company's quality system. The reported data are averaged results of multiple measurements with typical variation. LEDiL Oy reserves the right to without prior notification make changes and improvements to its products.

LEDiL Oy assumes neither warranty, nor guarantee nor any other liability of any kind for the contents and correctness of the provided data. The provided data has been generated with highest diligence but the provided data may in reality not represent the complete possible variation range of all intrinsic parameters. Therefore, in certain cases a deviation from the provided data could occur.

LEDiL Oy reserves the right to undertake technical changes of its products without further notification which could lead to changes in the provided data. LEDiL Oy assumes no liability of any kind for the possible deviation from any provided data or any other damage resulting from the usage of the provided data.

The user agrees to this disclaimer and user agreement with the download or usage of the provided files.

LEDiL Oy

Joensuunkatu 13
FI-24240 SALO
Finland

LEDiL Inc.

228 West Page Street
Suite D
Sycamore IL 60178
USA

Local sales and technical support

[www.ledil.com/
where_to_buy](http://www.ledil.com/where_to_buy)

Shipping locations

Salo, Finland
Hong Kong, China

Distribution Partners

[www.ledil.com/
where_to_buy](http://www.ledil.com/where_to_buy)