

Applications

- Electronic ballasts

Features

- Very long useful life
- High ripple current capability
- High voltage capability
550 V / 85 °C / 500 h
500 V / 105 °C / 4 000 h
- Outstanding performance
- Small dimensions

Construction

- Charge-discharge proof, polar
- Aluminum case with insulating sleeve
- Negative pole connected to case
- Axial leads, welded to ensure perfect electrical contact

Taping and packing

- Bulk
- Pallet package
- Capacitors with $d \times l \leq 16 \times 30$ mm are also available taped on reel.

For details on taping and packing, refer to page 342.

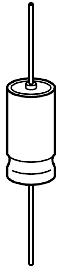

KAL0277-Z

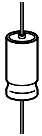
Specifications and characteristics in brief

Rated voltage U_R	450 VDC				
Surge voltage U_S	550 at 85 °C, 500 V at 105 °C				
Rated capacitance C_R	10 ... 47 μ F				
Capacitance tolerance	– 10/+ 30 % \triangle Q				
Leakage current I_L (5 min, 20 °C)	$I_L \leq 0,3 \mu\text{A} \cdot \left(\frac{C_R}{\mu\text{F}} \cdot \frac{U_R}{\text{V}} \right)^{0,7} + 4 \mu\text{A}$				
Self-inductance $ESL^1)$	Diameter d	12 mm	14 mm	16 mm	18 mm
	Length l	Approx. ESL (nH)			
	25 mm	—	22	26	—
	30 mm	21	24	29	34
	39 mm	—	—	33	38
Useful life		Requirements:			
105 °C; U_R ; I_{-R}	> 10 000 h	$\Delta C/C \leq \pm 30$ % of initial value			
105 °C; 500 V; I_{-R}	> 4 000 h	$ESR \leq 3$ times initial specified limit			
85 °C; U_R ; I_{-R}	> 25 000 h	$I_L \leq$ initial specified limit			
85 °C; U_R ; I_{-max}	> 50 000 h	Failure percentage: ≤ 1 %			
75 °C; 500 V; I_{-R}	> 50 000 h	Failure rate: ≤ 20 fit ($\leq 20 \cdot 10^{-9}/\text{h}$)			
40 °C; U_R ; $2,2 \cdot I_{-R}$	> 250 000 h	(for definition "fit", refer to chapter "Quality", page 62)			
Voltage endurance test		Post test requirements:			
105 °C; U_R	5 000 h	$\Delta C/C \leq \pm 10$ % of initial value			
		$ESR \leq 1,3$ % times initial specified limit			
		$I_L \leq$ initial specified limit			
Vibration resistance	To IEC 60068-2-6, test Fc: displacement amplitude 0,75 mm, frequency range 10 Hz to 55 Hz, acceleration max. 10 g, duration 3×2 h				
IEC climatic category	To IEC 60068-1: 40/105/56 (– 40 °C/+ 105 °C/56 days damp heat test)				
Detail specification	Similar to CECC 30301-801				
Sectional specification	IEC 60384-4				

1) If optimum circuit design is used, the values are lower by 30 %.



B43699

Compact – 105 °C

Dimensional drawings

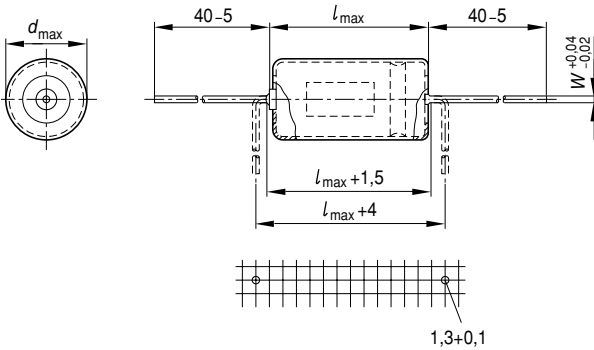

KAL0680-9

Dimensions, weights and packing units

$d \times l$ mm	$d_{\max} \times l_{\max}$ mm	Wire W mm	Approx. weight g	Packing units (pieces)		
				Bulk	Reel	Pallet
14 × 25	14,5 × 25,5	0,8	5,7	500	350	200
14 × 30	14,5 × 30,5	0,8	6,8	400	350	200
16 × 30	16,5 × 30,5	0,8	8,9	350	250	180
16 × 39	16,5 × 40	0,8	11,7	300	—	180
18 × 39	18,5 × 40	1,0	14,7	250	—	160

Case dimensions and ordering codes

U_R	C_R	Case dim. $d \times l$	Ordering code		
VDC	μF	mm	Bulk	Pallet package	Reel
450	10	14 × 25	B43699A5106Q000	B43699A5106Q007	B43699A5106Q009
	15	14 × 30	B43699A5156Q000	B43699A5156Q007	B43699A5156Q009
	22	16 × 30	B43699A5226Q000	B43699A5226Q007	B43699A5226Q009
	33	16 × 39	B43699A5336Q000	B43699A5336Q007	
	47	18 × 39	B43699A5476Q000	B43699A5476Q007	

Technical data

C_R	ESR_{typ}	ESR_{max}	ESR_{max}	ESR_{max}	Z_{max}	$I_{\text{~max}}$	$I_{\text{~max}}$	$I_{\text{~R}}$
100 Hz	100 Hz	100 Hz	100 Hz	10 kHz	100 kHz	10 kHz	10 kHz	10 kHz
20 °C	20 °C	20 °C	-25 °C	20 °C	20 °C	40 °C	85 °C	105 °C
μF	Ω	Ω	Ω	Ω	Ω	A	A	A
450 VDC								
10	5,1	8,3	165	3,9	3,8	1,20	0,95	0,50
15	3,4	5,5	110	2,6	2,5	1,60	1,25	0,67
22	2,3	3,8	75	1,8	1,7	2,00	1,60	0,84
33	1,6	2,5	50	1,2	1,1	2,80	2,20	1,15
47	1,1	1,7	35	0,9	0,8	3,50	2,75	1,45

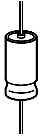

B43699

Compact – 105 °C

Useful life

depending on ambient temperature T_A under ripple current operating conditions at $U_R^{1)}$

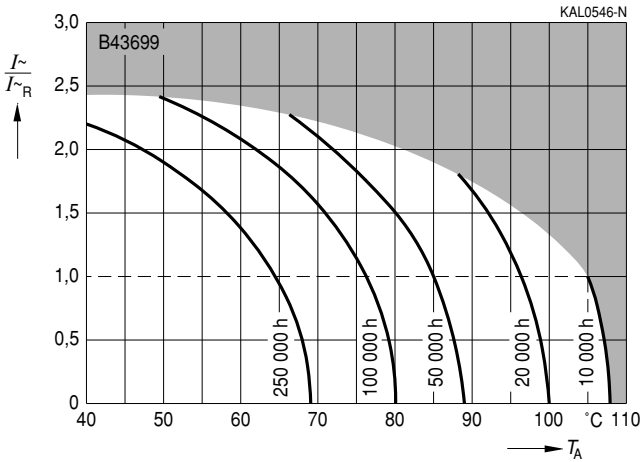

Useful life

depending on ambient temperature T_A under ripple current operating conditions at $U_{op}^{1)}$

$U_{op} = 500 V$

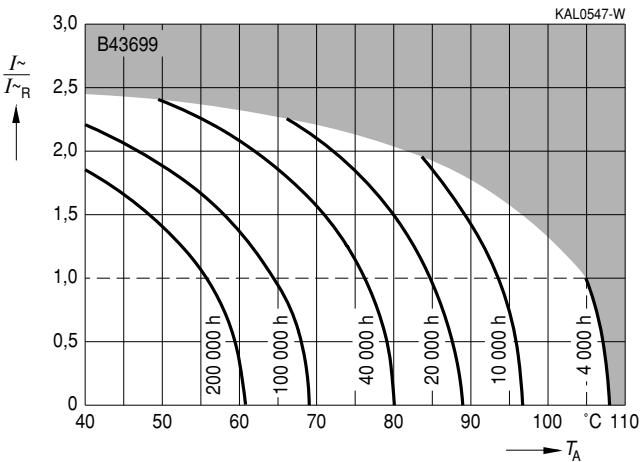

1) Refer to page 40 for an explanation on how to interpret the useful life graphs.

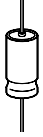

Frequency factor of permissible ripple current I_{\sim} versus frequency f

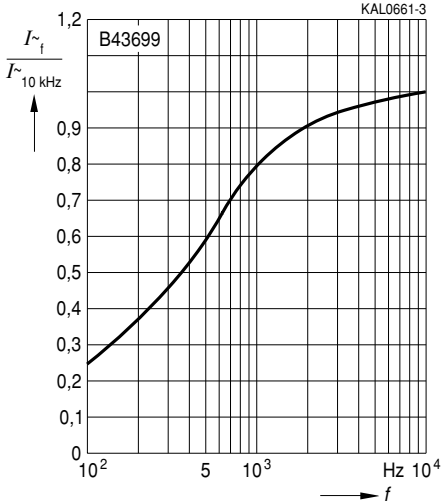

Frequency characteristics of ESR at different temperatures
Typical behavior

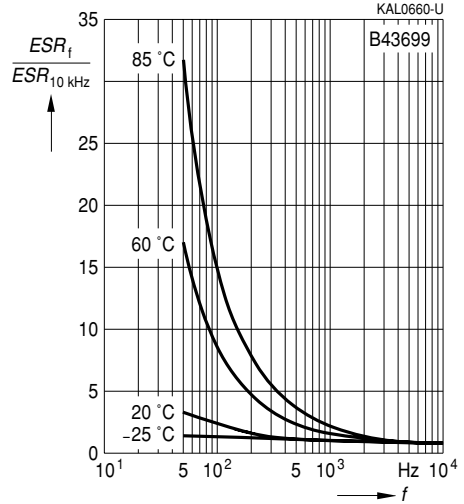

Equivalent series resistance ESR at different temperatures
Typical behavior for 22 μF/450 V

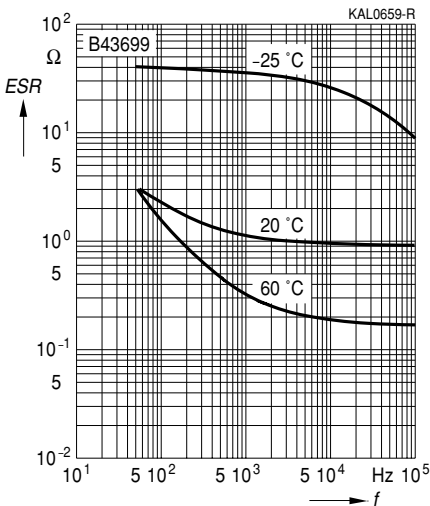

Impedance Z versus frequency f at different temperatures
Typical behavior for 10 μF/450 V

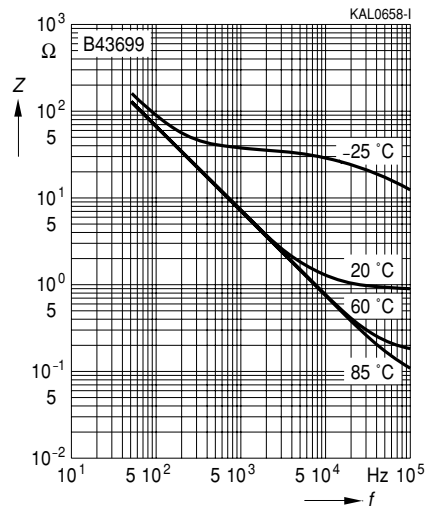

Herausgegeben von EPCOS AG

Unternehmenskommunikation, Postfach 80 17 09, 81617 München, DEUTSCHLAND

☎ ++49 89 636 09, FAX (0 89) 636-2 26 89

© EPCOS AG 2002. Vervielfältigung, Veröffentlichung, Verbreitung und Verwertung dieser Broschüre und ihres Inhalts ohne ausdrückliche Genehmigung der EPCOS AG nicht gestattet.

Bestellungen unterliegen den vom ZVEI empfohlenen Allgemeinen Lieferbedingungen für Erzeugnisse und Leistungen der Elektroindustrie, soweit nichts anderes vereinbart wird.

Diese Broschüre ersetzt die vorige Ausgabe.

Fragen über Technik, Preise und Liefermöglichkeiten richten Sie bitte an den Ihnen nächstgelegenen Vertrieb der EPCOS AG oder an unsere Vertriebsgesellschaften im Ausland. Bauelemente können aufgrund technischer Erfordernisse Gefahrstoffe enthalten. Auskünfte darüber bitten wir unter Angabe des betreffenden Typs ebenfalls über die zuständige Vertriebsgesellschaft einzuholen.

Published by EPCOS AG

Corporate Communications, P.O. Box 80 17 09, 81617 Munich, GERMANY

☎ ++49 89 636 09, FAX (0 89) 636-2 26 89

© EPCOS AG 2002. Reproduction, publication and dissemination of this brochure and the information contained therein without EPCOS' prior express consent is prohibited.

Purchase orders are subject to the General Conditions for the Supply of Products and Services of the Electrical and Electronics Industry recommended by the ZVEI (German Electrical and Electronic Manufacturers' Association), unless otherwise agreed.

This brochure replaces the previous edition.

For questions on technology, prices and delivery please contact the Sales Offices of EPCOS AG or the international Representatives.

Due to technical requirements components may contain dangerous substances. For information on the type in question please also contact one of our Sales Offices.