

DATE	REV	ECN	APP'D. BY
7-3-07	A6	8128	TRM
8-17-07	A7	8197	TRM

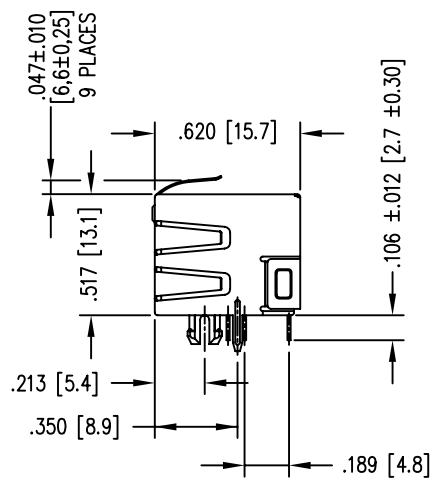

MATERIAL:
 HOUSING: PBT+30%G.F. UL94V-0. STANDARD COLOR: BLACK
 INSERT: PBT+30%G.F. UL94V-0. STANDARD COLOR: BLACK
 LENS: PC UL94V-0. STANDARD COLOR: CLEAR
 BACK: PBT+30%G.F. STANDARD COLOR: BLACK
 LED 3.2 x 2.0 x 4.0 x P=2.29mm.
 SHIELD: COPPER ALLOY 0.25mm THICKNESS.
 PRODUCT SPEC: PR022-01

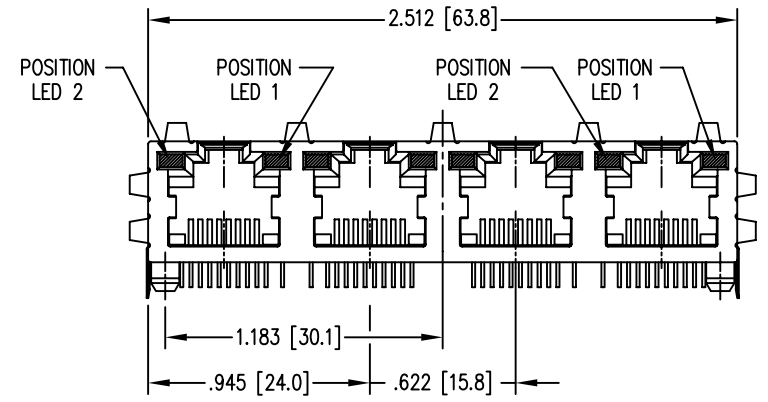
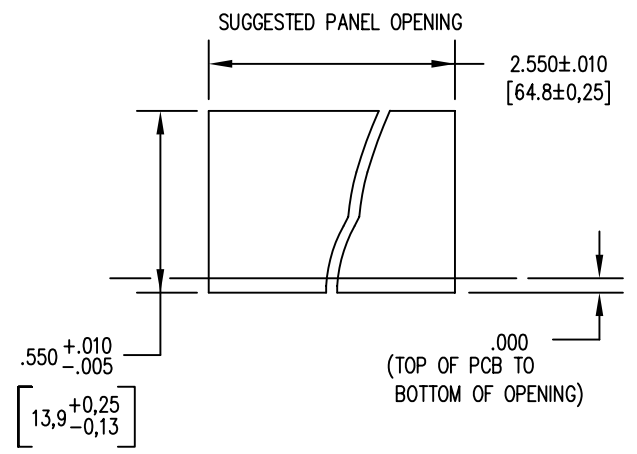

GREEN	RED	50 MICRO-INCHES [1.27um]	SS-74404-008
GREEN	GREEN	50 MICRO-INCHES [1.27um]	SS-74404-007
GREEN	YELLOW	50 MICRO-INCHES [1.27um]	SS-74404-006
YELLOW	GREEN	50 MICRO-INCHES [1.27um]	SS-74404-005
POSITION 2	POSITION 1	CONTACT PLATING	PART NUMBER
INDICATOR COLOR		IN MATING AREA	

THIRD ANGLE PROJECTION

 DO NOT SCALE DRAWING
 DRAWING IS SUBJECT TO CHANGE WITHOUT NOTICE
 DIMENSIONS: INCHES [METRIC]
 UNLESS OTHERWISE SPECIFIED TOLERANCES ARE ±.005 [0.13] ANGLES ARE ± 1°
 SHEET NO. 1 OF 1

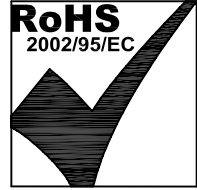

Bel Stewart Connector

11118 Susquehanna Trail South
 Glen Rock, PA 17327-9199
 (717) 235-7512 Fax: (717) 235-7954 <http://www.stewartconnector.com>

TITLE: EMI-RFI ONE PIECE SHIELDED, ESD GROUNDED
 4 PORT PCB HARMONICA LED JACK PAC

DRN BY: SAR	DATE 1-17-02
APPD BY: JRC	DATE 1-17-02
DWG NO. CT740092	REV. A7

THIS DRAWING AND THE SUBJECT MATTER SHOWN THEREON ARE CONFIDENTIAL AND THE PROPRIETARY PROPERTY OF BEL STEWART CONNECTOR AND SHALL NOT BE REPRODUCED, COPIED, OR USED IN ANY MANNER WITHOUT PRIOR WRITTEN CONSENT OF BEL STEWART CONNECTOR. THE SUBJECT MATTER MAY BE PATENTED OR A PATENT MAY BE PENDING.

B

B

A

A

REV. 7/3/03

B

B

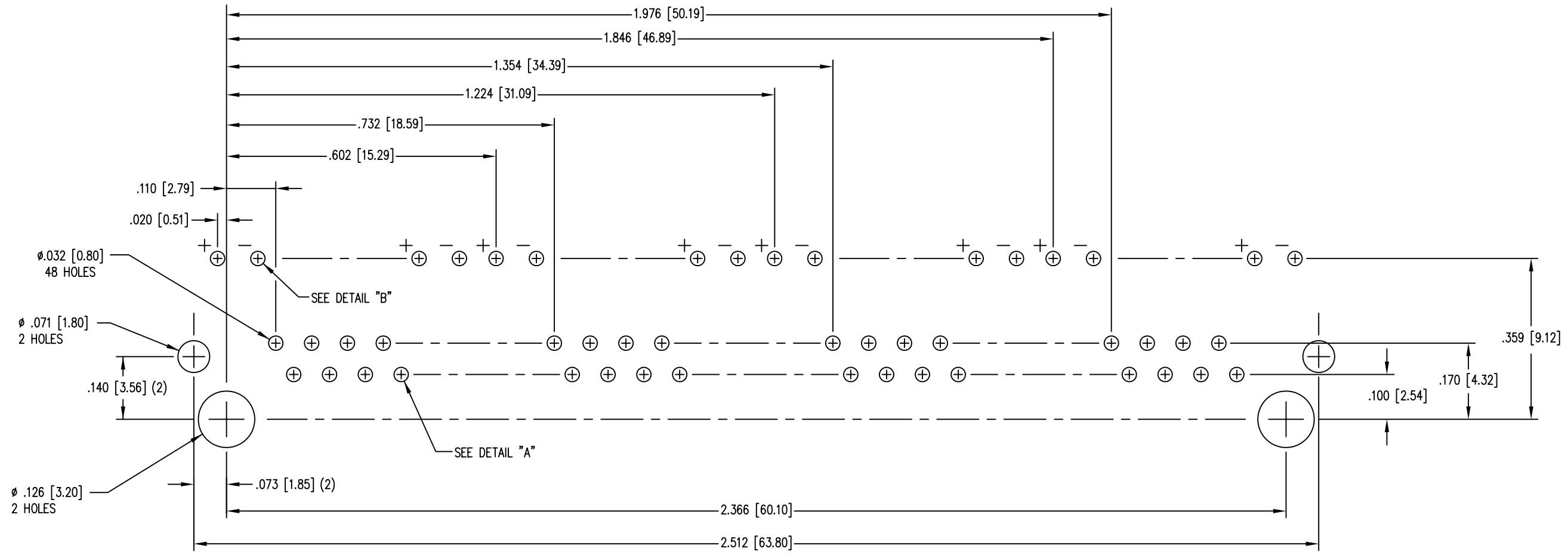

P.C.B. RECOMMENDED HOLE LAYOUT
 SEEN FROM COMPONENT SIDE
 TOLERANCE ±.003 [0.08] UNLESS OTHERWISE SPECIFIED

A

A

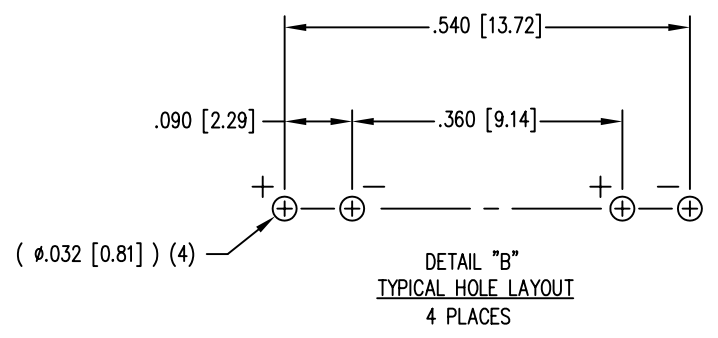
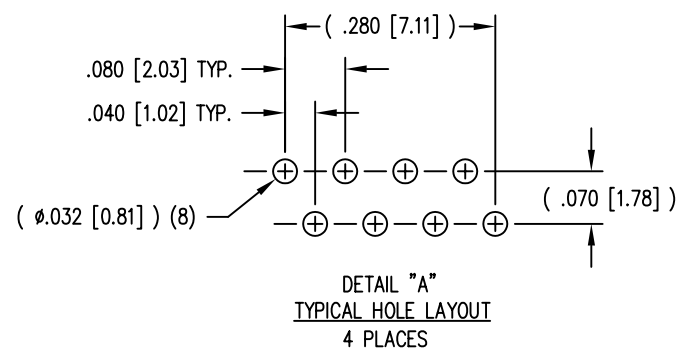

THIRD ANGLE PROJECTION 	Bel Stewart Connector 11118 Susquehanna Trail South Glen Rock, PA 17327-9199 (717) 235-7512 Fax: (717) 235-7954 http://www.stewartconnector.com	
DO NOT SCALE DRAWING DRAWING IS SUBJECT TO CHANGE WITHOUT NOTICE	TITLE: EMI-RFI ONE PIECE SHIELDED, ESD GROUNDED 4 PORT PCB HARMONICA LED JACK PAC	
DIMENSIONS: INCHES [METRIC]	THIS DRAWING AND THE SUBJECT MATTER SHOWN THEREON ARE CONFIDENTIAL AND THE PROPRIETARY PROPERTY OF BEL STEWART CONNECTOR AND SHALL NOT BE REPRODUCED, COPIED, OR USED IN ANY MANNER WITHOUT PRIOR WRITTEN CONSENT OF BEL STEWART CONNECTOR. THE SUBJECT MATTER MAY BE PATENTED OR A PATENT MAY BE PENDING.	DRN BY: SAR DATE 1-17-02 APPD BY: JRC DATE 1-17-02 DWG NO. CT740092 REV. A7
UNLESS OTHERWISE SPECIFIED TOLERANCES ARE ±.005 [0.13] ANGLES ARE ± 1°	SHEET NO. 2 OF 2	

REV. 7/3/03