



Data Display Products®
www.datadisplay.com

Panel-Mount LEDs



- For Panels from .060"(1.52) to .125"(3.13) Thick

1 Part #	Description
PMC-3	Clip for T-1 LED (Model 125)
PMC-2	Clip for T-1 ³ / ₄ LED (Model 200)

TO ORDER, FOLLOW THE EXAMPLE:

Select one **BOLD** component from SHADED column in the table at left.

1 Part #
PMC-3

→Part Number **PMC-3**

Mounting Instructions: For panels thicker than .060"(1.52) to .125"(3.13), counterboring is required. For PMC-2, drill a .257" (6.15) hole in the panel. For PMC-3, drill a .185"(4.70) hole in the panel. Deburr but do not chamfer. Snap in the PMC from the front of the panel. Holding tightly or using a nut driver, press the LED into the back of the clip. Slip the retaining ring onto the back of the clip and press tightly. Two nut drivers may be used.



PMC-3

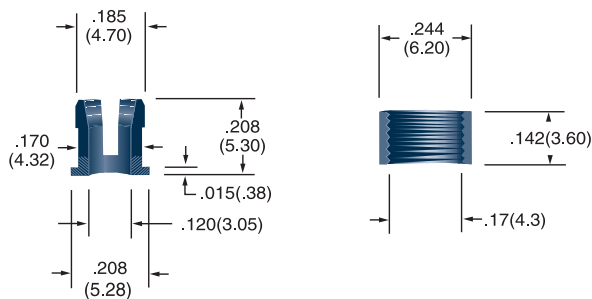

PMC-2

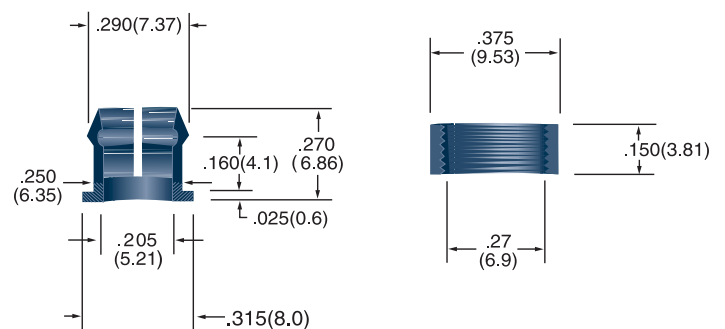

All dimensions are in inches (mm)

Tolerances: .xx"(x) ±.025"(.63) / .xxx"(xx)±.010"(.25)

Specifications are subject to change without notice.

WIDE ANGLE LENSED LEDs



Data Display Products®

Fresnel lens for Wide Angle Viewing

- Mates with Mounting Socket Model PS200 (Optional) - For Detailed LED Data, See Discrete Section, MODEL 125

1	Model
	PC3

TO ORDER, FOLLOW THE EXAMPLE:

Select one BOLD component from each SHADED column in the tables below.							
1	Model	2	LED	3	Voltage	4	Lens Color
	PC3		-BCG		2		-CG

→Part Number **PC3-BCG2-CG**

MEDIUM INTENSITY - TINTED ENCAPSULATION				
2	LED	Color	λ_{pk} (nm)	$I_v^{[1]}$ (mcd)
	-BCR	RED	635	60
	-BCA	AMB	583	30
	-BCG	GRN	565	44

3	Voltage (Ta=25°C)
	2
	External Resistor Required

4	Lens Color^[2]
	-CR Red
	-CA Amber
	-CY Yellow
	-CG Green
	-CW Water Clear
	-S Smoke

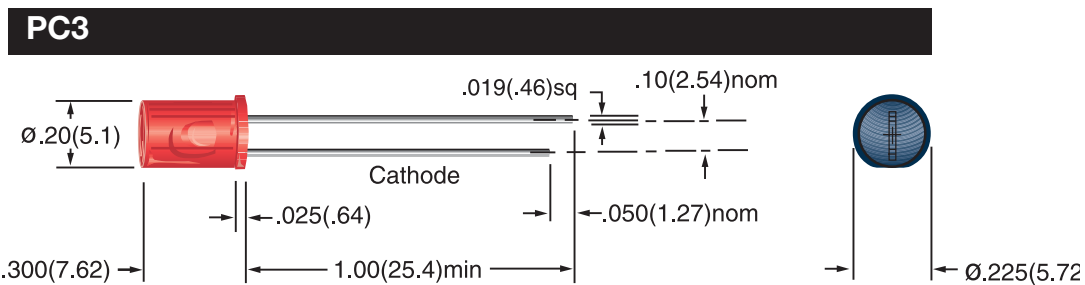

[1] I_v = typical luminous intensity @ $I_f = 20\text{mA}$ ($T_a = 25^\circ\text{C}$).

[2] Colored lenses must match LED colors (e.g. PC3-BCR2-CR). Water Clear (-CW) and Smoke (-S) lenses may be specified with any LED color.

All dimensions are in inches (mm)

Tolerances: .xx"(.x) $\pm 0.025"$ (.63) / .xxx"(.xx) $\pm 0.010"$ (.25)

Specifications are subject to change without notice.

- For Use with Discrete LEDs, Models 200 & PC3 - Mounting Diameter .250" (6.35) - RC200, KN40, LW40, HN40 Mounting Hardware Included

1	Model	Wires
	PS200	W (optional)

2	Bezel Finish
	-B Black
	-S Silver

3	Voltage ^[1]
	-5H
	-12H
	-15H
	-24H
	-28H
	-48H

Voltage/Current	
Design Vf/If ^[2]	Max Vf/If ^[2]
V/C Table I	
5V/27mA	5.5V/40mA
12V/27mA	14V/35mA
15V/24mA	16.5V/28mA
24V/17mA	26V/20mA
28V/16.5mA	30V/18mA
48V/15mA	50V/16mA

TO ORDER, FOLLOW THE EXAMPLE:

Select one **BOLD** component from each numbered category in the tables below.

1	Model	Wires	2	Bezel Finish	3	Voltage
	PS200	W		-B		-12H

→ Part Number **PS200W-B-12H**

PS200 With Resistor *PC3 LED not Included*

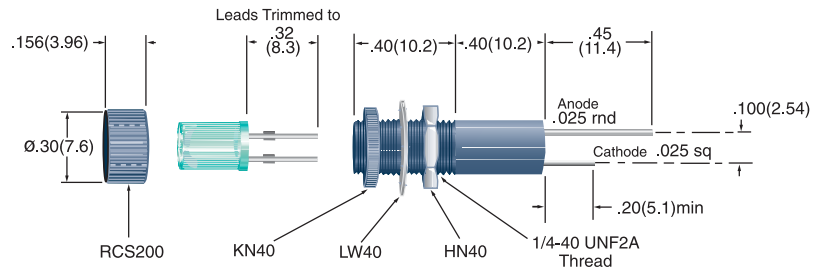

PS200 Without Resistor *Discrete LED not Included*

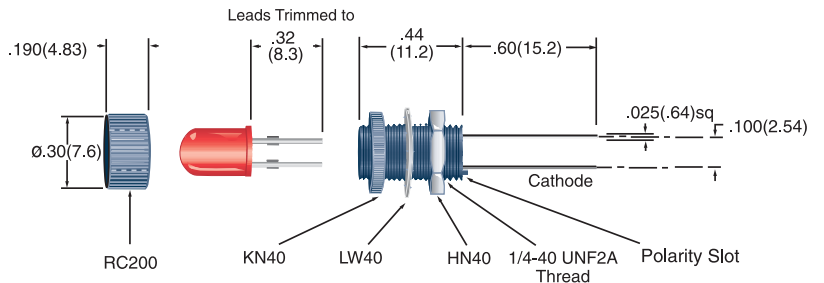

[1] Ta=25°C. Voltages 5H through 48H are VDC. For AC operation, insert D after Voltage (e.g. 24HD).

D indicates built-in rectifier; not required for 15VAC or less. For a socket without a built-in resistor, omit Voltage (e.g. PS200-B).

[2] Design current will vary depending on LED used.

Standard Wire Leads:

6.0" total length(nominal)/.50" stripped (nominal), red anode/black cathode, 24 AWG TPB UL1061 insulation. Contact factory for other lengths, gauges and colors.

All dimensions are in inches (mm)

Tolerances: .xx"(.x) ±.025"(.63) / .xxx"(.xx)±.010"(.25)
Specifications are subject to change without notice.

.156" SNAP-IN PANEL LIGHT



Data Display Products®

T-1

- Mounting Diameter .155"(3.94) to .158"(4.01) - For Panels .031"(.79) to .125" (3.18) Thick - For Detailed LED Data, See Discrete Section, MODEL 125

1	Model	Wires
	P205	W (optional)

TO ORDER, FOLLOW THE EXAMPLE:

Select one **BOLD** component from each numbered category in the tables below.

1	Model	2	LED	3	Voltage
	P205		-BCR		2

→Part Number **P205-BCR2**

STANDARD INTENSITY - DIFFUSED ENCAPSULATION					
LED	Color	λpk (nm)	Iv ^[1] (mcd)	Viewing Angle	V/C Table ^[3]
-BR	RED	635	14	60	I
-BA	AMB	583	14	60	I
-BG	GRN	565	14	60	I

MEDIUM INTENSITY - TINTED ENCAPSULATION					
LED	Color	λpk (nm)	Iv ^[1] (mcd)	Viewing Angle	V/C Table ^[3]
-BCR	RED	635	60	45	I
-BCA	AMB	583	30	45	I
-BCG	GRN	565	44	45	I

HIGH INTENSITY - WATERCLEAR ENCAPSULATION					
LED	Color	λpk (nm)	Iv ^[1] (mcd)	Viewing Angle	V/C Table ^[3]
-NWR	RED	634	3200	35	I
-NWA	AMB	592	2500	35	I
-NWG	GRN	520	2000	45	II
-NWB	BLU	465	600	45	II
-NWW	WHT	[5]	1100	55	II

SPECIALTY LEDs						
LED	Color	λpk (nm)	Iv ^[1] (mcd)	Viewing Angle	V/C Table ^[3]	Description
-RLP ^[2]	RED	635	2.1	50	I	Low Power
-ALP ^[2]	AMB	583	1.6	50	I	Low Power
-GLP ^[2]	GRN	565	2.1	50	I	Low Power
-DRG	RED/GRN	635/567	4.3/3.7	118	I	Bi-Color, Red Cathode

Voltage/Current	
Design Vf/If	Max Vf/If
V/C Table I	
5V/27mA	5.5V/40mA
12V/27mA	14V/35mA
15V/24mA	16.5V/28mA
24V/17mA	26V/20mA
28V/16.5mA	30V/18mA

Voltage/Current	
Design Vf/If	Max Vf/If
V/C Table II	
5V/15mA	6V/26mA
12V/15mA	14V/20mA
15V/15mA	16.5V/18mA
24V/15mA	26V/18mA
28V/15mA	30V/17mA

3	Voltage^[4]
	2
	5H
	12H
	15H
	24H
	28H

[1] Iv = typical luminous intensity @ If = 20mA (Ta=25°C), Low Power LEDs @ If = 2mA. Bi-color LEDs @ If=10mA.

[2] Omit the H when selecting a voltage. (e.g. P205-RLP12).

[3] See Voltage/Current table for design specifications. Design current for low power LEDs = 2mA.

[4] Ta = 25°C. Voltage "2" indicates external resistor required. Voltages 5H through 28H are VDC. For AC operation, insert D after Voltage (e.g. 24HD). D indicates built-in rectifier; not required for 15H or less. Bi-Color not available in AC voltages.

[5] White is identified by one of four CIE coordinates: x:0.29/y:0.23, x:0.29/y:0.27, x:0.32/y:0.32, x:0.32/y:0.28.



P205

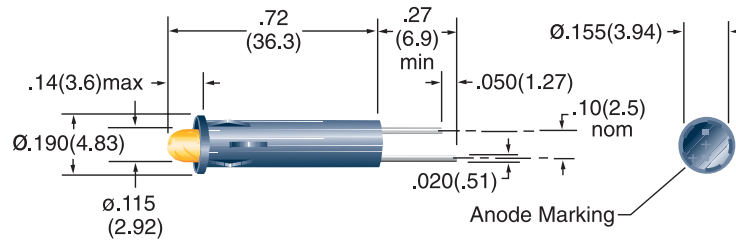

Standard Wire Leads:

6.0" total length(nominal)/.50" stripped (nominal), red anode/black cathode, 24 AWG TPB UL1061 insulation. Contact factory for other lengths, gauges and colors.

All dimensions are in inches (mm)

Tolerances: .xx"(.x) $\pm .025$ "(.63) / .xxx"(.xx) $\pm .010$ "(.25)
Specifications are subject to change without notice.

.250" SNAP-IN PANEL LIGHT



Data Display Products®

T-1 Flush Mount Lens

- Mounting Diameter .249"(6.32) to .252"(6.40) - For Panels .031"(.79) to .125" (3.18) Thick - For Detailed LED Data, See Discrete Section, MODEL 125

TO ORDER, FOLLOW THE EXAMPLE:

Select one **BOLD** component from each numbered category in the tables below.

1 Model	Wire	2 LED	3 Voltage	4 Lens Color
PR44	W	-BCG	12H	-CG

→Part Number **PR44W-BCG12H-CG**

1 Model	Wires	Description
P44 PR44	W (optional)	Voltage = 2 (External Resistor Required) Voltages 5H - 28H

MEDIUM INTENSITY - TINTED ENCAPSULATION					
2 LED	Color	λ_{pk} (nm)	$I_v^{[1]}$ (mcd)	Viewing Angle	V/C Table ^[3]
-BCR	RED	635	60	45	I
-BCA	AMB	583	30	45	I
-BCG	GRN	565	44	45	I

HIGH INTENSITY - WATERCLEAR ENCAPSULATION					
LED	Color	λ_{pk} (nm)	$I_v^{[1]}$ (mcd)	Viewing Angle	V/C Table ^[3]
-NWR	RED	660	3200	35	I
-NWA	AMB	592	2500	35	I
-NWG	GRN	520	2000	45	II
-NWB	BLU	465	600	45	II
-NWW ^[5]	WHT	[5]	1100	55	II

Voltage/Current	
Design Vf/If	Max Vf/If
V/C Table I	
5V/27mA	5.5V/40mA
12V/24mA	14V/26mA
15V/24mA	16.5V/28mA
24V/17mA	26V/20mA
28V/16.5mA	30V/18mA

Voltage/Current	
Design Vf/If	Max Vf/If
V/C Table II	
5V/15mA	6V/26mA
12V/15mA	14V/20mA
15V/15mA	16.5V/18mA
24V/15mA	26V/18mA
28V/15mA	30V/17mA

3 Voltage ^[2]
2
5H
12H
15H
24H
28H

4 Lens Color ^[4]
-CR Red
-CA Amber
-CY Yellow
-CG Green
-CB Blue
-CW Water Clear
-S Smoke

[1] I_v = typical luminous intensity @ $I_f = 20mA$ ($T_a = 25^\circ C$).

[2] $T_a = 25^\circ C$. Voltages 5H - 28H are DC. For AC operation, insert D after voltage. D indicates built-in rectifier, not required for 15VAC or less (e.g. 24HD).

[3] See voltage/current table for design specifications.

[4] Colored lenses must match LED colors (e.g. PR44-BCR5H-CR). Water Clear and Smoke lenses may be specified with any LED color.

[5] White is identified by one of four CIE coordinates: x:0.29/y:0.23, x:0.29/y:0.27, x:0.32/y:0.32, x:0.32/y:0.28. Select -CW lens only.

Standard Wire Leads:

6.0" total length(nominal)/.50" stripped (nominal), red anode/black cathode, 24 AWG TPB UL1061 insulation. Contact factory for other lengths, gauges and colors.

All dimensions are in inches (mm)

Tolerances: .xx"(.x) $\pm 0.025"$ (.63) / .xxx"(.xx) $\pm 0.010"$ (.25)
Specifications are subject to change without notice.



P44

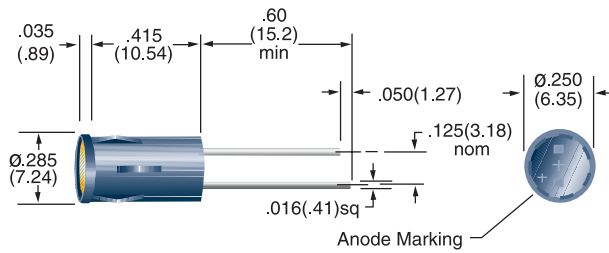

PR44

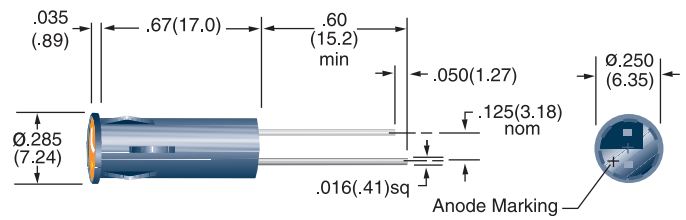

Standard Wire Leads:

6.0" total length(nominal)/.50" stripped (nominal), red anode/black cathode, 24 AWG TPB UL1061 insulation. Contact factory for other lengths, gauges and colors.

All dimensions are in inches (mm)

Tolerances: .xx"(x) ±.025"(.63) / .xxx"(xx)±.010"(.25)
Specifications are subject to change without notice.

.250" SNAP-IN PANEL LIGHT



Data Display Products®

T-1^{3/4} Standard Profile

- Mounting Diameter .249"(6.32) to .252"(6.40) - For Panels .031"(.79) to .125" (3.18) Thick - For Detailed LED Data, See Discrete Section, MODEL 200

TO ORDER, FOLLOW THE EXAMPLE:

Select one **BOLD** component from each numbered category in the tables below.

1	Model	2	LED	3	Voltage
	PR405		-BR		12H

→Part Number **PR405-BR12H:**

1	Model	Wires	Description
	P405 PR405	W (optional)	Voltage = 2 (External Resistor Required) Voltages 5H - 120

STANDARD INTENSITY - DIFFUSED ENCAPSULATION						
2	LED	Color	λ_{pk} (nm)	Iv ^[1] (mcd)	Viewing Angle	V/C Table ^[3]
	-BR	RED	635	14	60	I
	-BA	AMB	583	16	60	I
	-BG	GRN	565	10	60	I

MEDIUM INTENSITY - TINTED ENCAPSULATION					
LED	Color	λ_{pk} (nm)	Iv ^[1] (mcd)	Viewing Angle	V/C Table ^[3]
-BCR	RED	635	120	35	I
-BCA	AMB	583	100	35	I
-BCG	GRN	565	80	24	I

HIGH INTENSITY - WATERCLEAR ENCAPSULATION					
LED	Color	λ_{pk} (nm)	Iv ^[1] (mcd)	Viewing Angle	V/C Table ^[3]
-NWR	RED	634	5300	30	I
-NWO	ORG	605	2000	30	I
-NWA	AMB	592	5300	30	I
-NWG	GRN	520	2400	45	II
-NWB	BLU	465	700	45	II
-NWW	WHT	[2]	1560	50	II
-NKR	RED	634	6900	15	I
-NKO	ORG	605	8000	15	I
-NKA	AMB	592	6900	15	I
-NKG	GRN	520	10000	15	II
-NKB	BLU	465	3000	15	II
-NKW	WHT	[2]	5600	20	II

SPECIALTY LEDs - DIFFUSED ENCAPSULATION						
LED	Color	λ_{pk} (nm)	Iv ^[1] (mcd)	Viewing Angle	V/C Table ^[3]	Description
-RLP ^[6]	RED	635	2.3	50	[3]	Low Power
-ALP ^[6]	AMB	583	2.1	50	[3]	Low Power
-GLP ^[6]	GRN	565	2.3	50	[3]	Low Power
-LRG	RED/GRN	660/565	90/40	60	I	Bi-Color, Red Cathode

Voltage/Current	
Design Vf/If	Max Vf/If
V/C Table I	
5V/27mA	5.5V/40mA
12V/27mA	14V/35mA
15V/24mA	16.5V/28mA
24V/17mA	26V/20mA
28V/16.5mA	30V/18mA
48V/15mA	50V/16mA
60V/9mA	65V/10mA
120VAC/3.5mA	130VAC/4mA

Voltage/Current	
Design Vf/If	Max Vf/If
V/C Table II	
5V/15mA	6V/36mA
12V/15mA	14V/20mA
15V/15mA	16.5V/18mA
24V/15mA	26V/18mA
28V/15mA	30V/17mA
48V/9.5mA	50V/10mA
60V/7mA	65V/8mA
120VAC/3.5mA	130VAC/4mA

3	Voltage^[4]
	2
	5H
	12H
	15H
	24H
	28H
	48H
	60H
	120 ^[5]

[1] Iv = typical luminous intensity @ If = 20mA (Ta=25°C), Low Power LEDs @ If = 2mA.

[2] White is identified by one of four CIE coordinates x:0.290/y:0.260, x:0.290/y:0.305, x:0.330/y:0.365, x:0.330/y:0.320

[3] See Voltage/Current table for design specifications. Design current for low power LEDs = 2mA.

[4] Ta = 25°C. Voltages 5H through 60H and VDC. For AC operation, insert D after Voltage (e.g. 24HD). D indicates built-in rectifier, not required for 15VAC or less or 120VAC. DC operation not available for 120V. Bi-Color not available in AC voltages.

[5] Select high intensity LEDs only.

[6] Omit the H when selecting voltage (e.g. PR405-RLP12).



P405

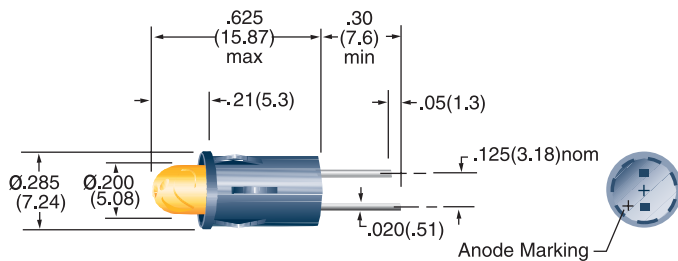

PR405

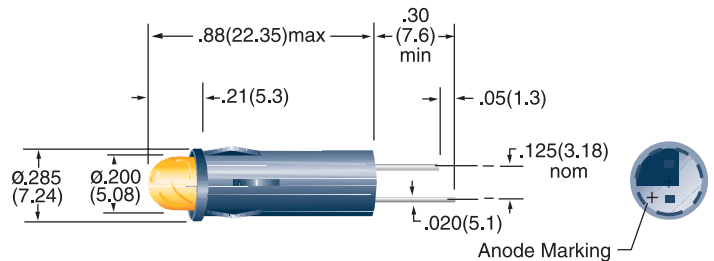

Standard Wire Leads:

6.0" total length(nominal)/.50" stripped (nominal), red anode/black cathode, 24 AWG TPB UL1061 insulation. Contact factory for other lengths, gauges and colors.

All dimensions are in inches (mm)

Tolerances: .xx"(.x) ±.025"(.63) / .xxx"(.xx)±.010"(.25)
Specifications are subject to change without notice.

.190" MOUNT PANEL LIGHTS



Data Display Products®

30 Series

- Mounting Hardware Provided - For Detailed LED Data, See Discrete Section, MODEL 125

1 Model	Wires
305 ^[1]	W
31	(optional)
34	

TO ORDER, FOLLOW THE EXAMPLE:

Select one **BOLD** component from each numbered category in the tables below.

1 Model	2 LED	3 Voltage	4 Lens Diffusion	5 Lens Color	6 Bezel Color
34	-BCR	24H	-C	R	0

→ Part Number **34-BCR24H-CR0**

STANDARD INTENSITY - DIFFUSED ENCAPSULATION					
2 LED	Color	λpk (nm)	Iv ^[2] (mcd)	Viewing Angle	V/C Table ^[3]
-BR	RED	635	14	60	I
-BA	AMB	583	14	60	I
-BG	GRN	565	14	60	I

MEDIUM INTENSITY - TINTED ENCAPSULATION					
LED	Color	λpk (nm)	Iv ^[2] (mcd)	Viewing Angle	V/C Table ^[3]
-BCR	RED	635	60	45	I
-BCA	AMB	583	30	45	I
-BCG	GRN	565	44	45	I

HIGH INTENSITY - WATERCLEAR ENCAPSULATION					
LED	Color	λpk (nm)	Iv ^[2] (mcd)	Viewing Angle	V/C Table ^[3]
-NWR	RED	634	2500	35/35	I
-NWA	AMB	592	3200	35/35	I
-NWG	GRN	520	2000	45	II
-NWB	BLU	465	600	45	II
-NWW^[6]	WHT	[9]	1100	55	II

Voltage/Current	
Design Vf/If	Max Vf/If
V/C Table I	
5V/27mA	5.5V/40mA
12V/27mA	14V/35mA
15V/24mA	16.5V/28mA
24V/17mA	26V/20mA
28V/16.5mA	30V/18mA
48V/15mA	50V/16mA
60V/9mA	65V/10mA
120VAC/3.5mA	130VAC/4mA

Voltage/Current	
Design Vf/If	Max Vf/If
V/C Table II	
5V/15mA	6V/25mA
12V/15mA	14V/20mA
15V/15mA	16.5V/18mA
24V/15mA	26V/18mA
28V/15mA	30V/17mA
48V/9.5mA	50V/10mA
60V/7mA	65V/8mA
120VAC/3.5mA	130VAC/4mA

3 Voltage ^[4]
2
5H
12H
15H
24H
28H
48H
60H
120 ^[8]

4 Lens Diffusion
-C
Clear
-N
Diffused

5 Lens Color	
R Red	B Blue
A Amber	W Water Clear
Y Yellow	
G Green	-S Smoke ^[7]

SPECIALTY LEDs						
LED	Color	λpk (nm)	Iv ^[2] (mcd)	Viewing Angle	V/C Table ^[3]	Description
-RLP^[5]	RED	635	2.1	50	[3]	Low Power
-ALP^[5]	AMB	583	1.6	50	[3]	Low Power
-GLP^[5]	GRN	565	2.1	50	[3]	Low Power
-DRG^[6]	RED/GRN	635/567	4.3/3.7	118	I	Bi-Color, Red Cathode

6 Bezel Color
0
Black
9
White

[1] Model 305 has no lens. Omit Lens Diffusion and Color (e.g. 305-NWG5H-0).

[2] Iv = typical luminous intensity @ If = 20mA (Ta = 25°C). Iv is measured without lenses. For Low Power LEDs, If = 2mA. For Bi-color LEDs, If = 10mA.

[3] See Voltage/Current table for design specifications. Design current for low power LEDs = 2mA.

[4] Ta = 25°C. Voltage "2" indicates external resistor required. Voltages 5H through 60H are VDC. For AC operation, insert D after Voltage (e.g. 24HD). D indicates built-in rectifier; not required for 15H or less, or 120VAC or greater. DC operation not available for 120V. Bi-Color not available in AC voltages.

[5] Omit H when selecting a voltage (e.g. 31-RLP12).

[6] Select -CW or -NW lens only.

[7] Omit Lens Diffusion when selecting smoked lens (e.g. 31-NWG28H-S0).

[8] Select high intensity LEDs only.

[9] White is identified by one of four CIE coordinates x:0.29/y:0.23, x:0.29/y:0.27, x:0.32/y:0.32, x:0.32/y:0.28.



305 (no lens)

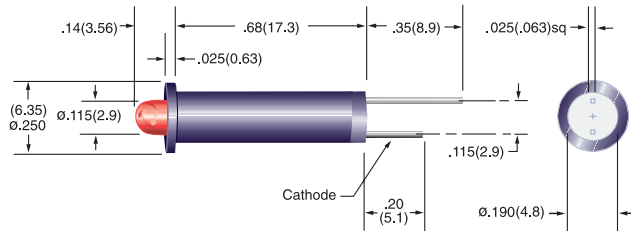

31

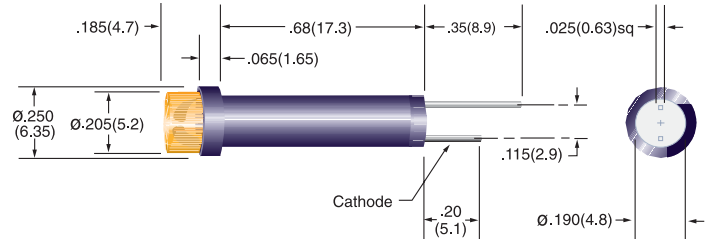

34 (flush lens)

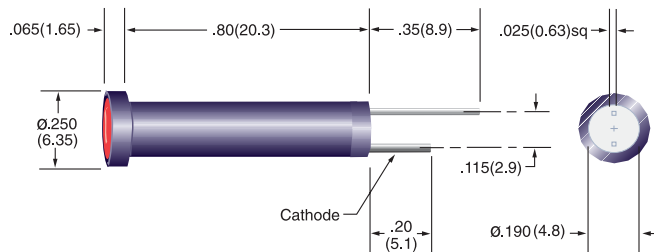

TC3 & NW3, Mounting Hardware

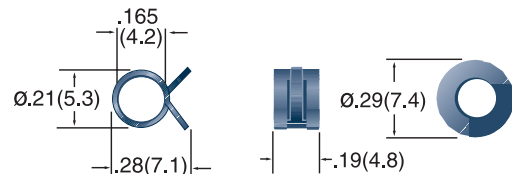

Standard Wire Leads:

6.0" total length(nominal)/.50" stripped (nominal), red anode/black cathode, 24 AWG TPB UL1061 insulation. Contact factory for other lengths, gauges and colors.

All dimensions are in inches (mm)

Tolerances: .xx"(.x) ±.025"(.63) / .xxx"(.xx)±.010"(.25)
Specifications are subject to change without notice.

.250" MOUNT PANEL LIGHTS



Data Display Products®

40 Series

- Mounting Hardware Provided - For Detailed LED Data, See Discrete Section, MODEL 200

1 Model	Wires
C ^[1] (optional)	W (optional)
405 ^[2]	
41	
44	
46	
461	
464	

TO ORDER, FOLLOW THE EXAMPLE:

Select one **BOLD** component from each numbered category in the tables below.

1 Model	2 LED	3 Voltage	4 Lens Diffusion	5 Lens Color	6 Bezel Color
41	-BCG	5H	-C	G	0

→ Part Number **41-BCG5H-CG0**

STANDARD INTENSITY - DIFFUSED ENCAPSULATION					
2 LED	Color	λpk (nm)	Iv ^[3] (mcd)	Viewing Angle	V/C Table ^[5]
-BR	RED	635	14	60	I
-BA	AMB	583	16	60	I
-BG	GRN	565	10	60	I

Voltage/Current	
Design Vf/I _f	Max Vf/I _f
V/C Table I	
5V/27mA	5.5V/40mA
12V/27mA	14V/35mA
15V/24mA	16.5V/28mA
24V/17mA	26V/20mA
28V/16.5mA	30V/18mA
48V/15mA	50V/16mA
60V/9mA	65V/10mA
120VAC/3.5mA	130VAC/4mA

3 Voltage ^[6]
2
5H
12H
15H
24H
28H
48H
60H
120 ^[9]

MEDIUM INTENSITY - TINTED ENCAPSULATION					
LED	Color	λpk (nm)	Iv ^[3] (mcd)	Viewing Angle	V/C Table ^[5]
-BCR	RED	635	120	35	I
-BCA	AMB	583	100	35	I
-BCG	GRN	565	80	24	I

Voltage/Current	
Design Vf/I _f	Max Vf/I _f
V/C Table II	
5V/15mA	6V/26mA
12V/15mA	14V/20mA
15V/15mA	16.5V/18mA
24V/15mA	26V/18mA
28V/15mA	30V/17mA
48V/9.5mA	50V/10mA
60V/7mA	65V/8mA
120VAC/3.5mA	130VAC/4mA

4 Lens Diffusion
-C Clear
-N Diffused

HIGH INTENSITY - WATERCLEAR ENCAPSULATION					
LED	Color	λpk (nm)	Iv ^[3] (mcd)	Viewing Angle	V/C Table ^[5]
-NWR	RED	634	5300	30	I
-NWO	ORG	605	2000	30	I
-NWA	AMB	592	5300	30	I
-NWG	GRN	520	2400	45	II
-NWB	BLU	465	700	45	II
-NWW ^[8]	WHT	[4]	1560	50	II
-NKR	RED	634	6900	15	I
-NKO	ORG	605	8000	15	I
-NKA	AMB	592	6900	15	I
-NKG	GRN	520	10000	15	II
-NKB	BLU	465	3000	15	II
-NKW ^[8]	WHT	[4]	5600	20	II

5 Lens Color			
R Red	B Blue		
A Amber	W Water Clear		
Y Yellow			
G Green	-S Smoke ^[10]		

SPECIALTY LEDs						
LED	Color	λpk (nm)	Iv ^[3] (mcd)	Viewing Angle	V/C Table ^[5]	Description
-RLP ^[7]	RED	635	2.3	50	[5]	Low Power
-ALP ^[7]	AMB	583	2.1	50	[5]	Low Power
-GLP ^[7]	GRN	565	2.3	50	[5]	Low Power
-LRG ^[8]	RED/GRN	660/565	90/40	60	I	Bi-Color, Red Cathode
-RAG ^[8]	RED/AMB/GRN	630/565	6/6/6	60	I	Tri-Color, Common Cathode
-GAR ^[8]	GRN/AMB/RED	635/565	5/5/5	50	I	Tri-Color, Common Anode

6 Bezel Color
0 Black
9 White

[1] The C option specifies a pin length = .20" for panel lights mounted in the PS40 or PS44 socket (pg. 50). Mounting hardware is included with the socket. Do not select the W option.

[2] Model 405 has no lens. Omit the Lens Diffusion and Color (e.g. 405-BG5H-0).

[3] Iv = typical luminous intensity @ If = 20mA (Ta = 25°C). Iv is measured without lenses. For Low Power LEDs, If = 2mA.

[4] White is identified by one of four CIE coordinates x:0.290/y:0.260, x:0.290/y:0.305, x:0.330/y:0.365, x:0.330/y:0.320

[5] See Voltage/Current table for design specifications. Design current for low power LEDs = 2mA.

[6] Ta = 25°C. Voltage "2" indicates external resistor required. Voltages 5H through 60H are VDC.

For AC operation, insert D after Voltage (e.g. 24HD), D indicates built-in rectifier; not required for 15H or less, or 120VAC. DC operation not available for 120V. Bi-Color and Tri-Color not available in AC voltages.

[7] Omit H when selecting a voltage (e.g. 41-RLP12-CW0).

[8] Select -CW or -NW lens only. -RAG Wire Leads: green anode/black cathode/red anode. -GAR Wire Leads: green cathode/black anode/red cathode. Common lead is the first lead clockwise from reference mark on header. Tri-Color 5 or 12 volt, omit H in part number.

[9] Select high intensity LEDs only.

[10] Omit lens diffusion when selecting smoked lens. (e.g. 46-NWR-S0).

405 (no lens)

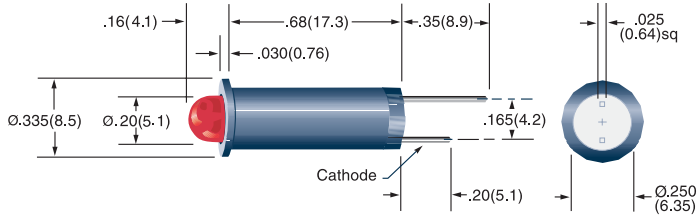

41

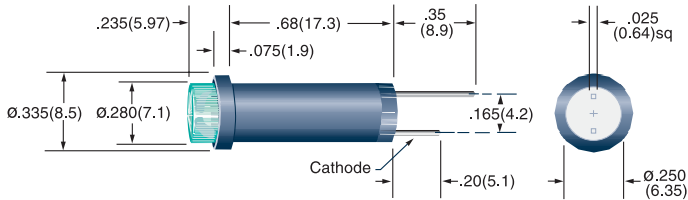

44 (flush lens)

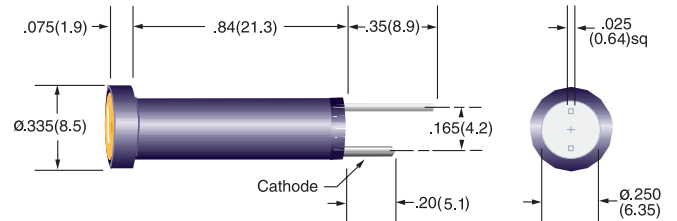

46

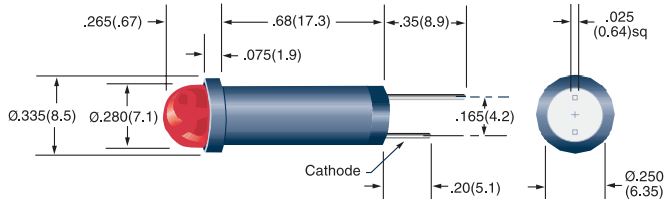

461

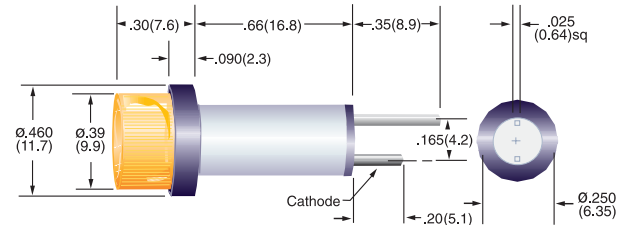

464

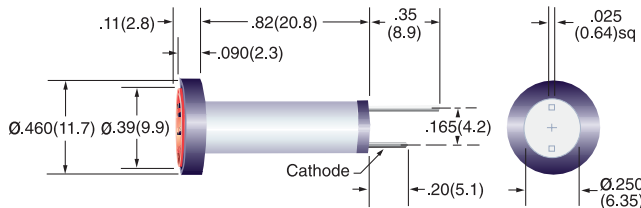

TC4 & NW4, Mounting Hardware see note [1]

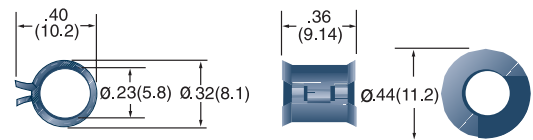

Standard Wire Leads:

6.0" total length(nominal)/.50" stripped (nominal), red anode/black cathode, 24 AWG TPB UL1061 insulation. Contact factory for other lengths, gauges and colors.

All dimensions are in inches (mm)

Tolerances: .xx"(.x) ±.025"(.63) / .xxx"(.xx)±.010"(.25)
Specifications are subject to change without notice.

.250" MOUNT PANEL LIGHT SOCKETS

40 Series Mounting Hardware

- Sockets for 40 Series Panel Lights

TO ORDER, FOLLOW THE EXAMPLE:

Select one **BOLD** component from each SHADED column in the tables below.

1	Model/ Part #	2	# of Pins
	PS40		-2

→ Part Number **PS40-2**

40 SERIES SOCKETS & WIRING PLUGS		
1	Model	Description
	PS40	Sockets for use with Models C405, C41, C46, C461
	PS44	Sockets for use with Models C44, C464
	SH40	Wiring Plug for use with 40 or C40 series
	CSH40	Wiring Plug for use with C40 series

2		Number of Pins	Configuration
		-2	2, 4
		-3	1, 2, 4
		-4	1, 2, 3, 4

40 SERIES HARDWARE	
Part Number	Description
CS24	Gold Plated Crimp Terminals
CS24T	Tin Plated Crimp Terminals
TC4	40 Series Mounting Clip
NW4	40 Series Mounting Washer

PS40 TC5 & NW5 mounting hardware provided

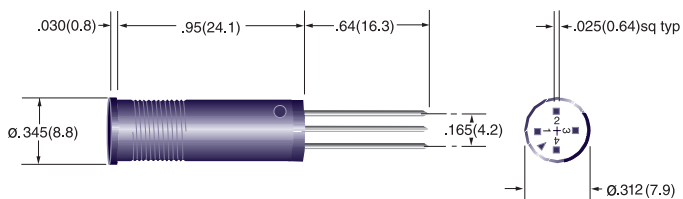

PS44 TC5 & NW5 mounting hardware provided

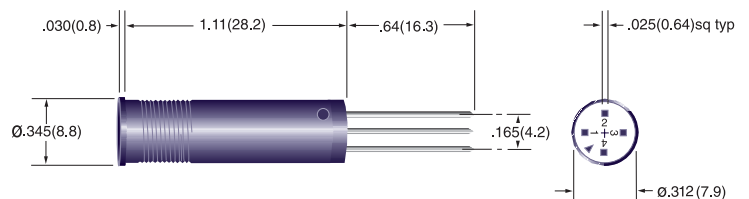



SH40

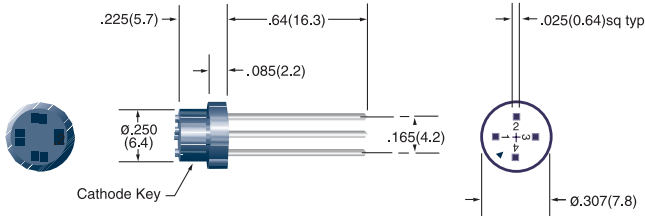

CSH40

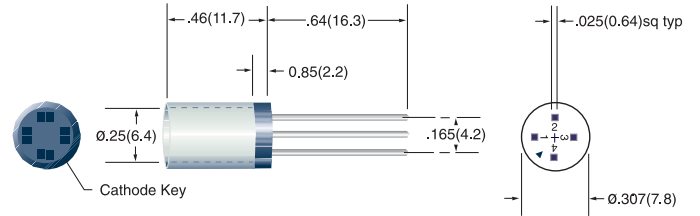

CS24 & CS24T 22AWG to 28AWG

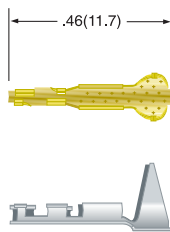

TC4 & NW4, Mounting Hardware

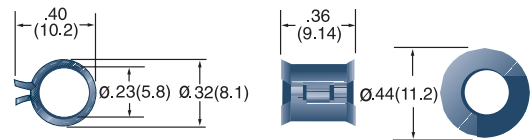

All dimensions are in inches (mm)

Tolerances: .xx"(.x) ±.025"(.63) / .xxx"(.xx)±.010"(.25)

Specifications are subject to change without notice.

.290" MOUNT PANEL LIGHTS



Data Display Products®

90 Series

- Mounting Hardware Provided - For Detailed LED Data, See Discrete Section, MODEL 200

1 Model	Wires
C ^[1] (optional)	W (optional)
905 ^[2]	
91	
94	
96	
961	
964	

TO ORDER, FOLLOW THE EXAMPLE:

Select one **BOLD** component from each numbered category in the tables below.

1 Model	2 LED	3 Voltage	4 Lens Diffusion	5 Lens Color	6 Bezel Color
94	-LRG	12H	-C	W	0

→ Part Number **94-LRG12H-CW0**

STANDARD INTENSITY - DIFFUSED ENCAPSULATION					
2 LED	Color	λpk (nm)	Iv ^[3] (mcd)	Viewing Angle	V/C Table ^[5]
-BR	RED	635	14	60	I
-BA	AMB	583	16	60	I
-BG	GRN	565	10	60	I

Voltage/Current	
Design Vf/If	Max Vf/If
V/C Table I	
5V/27mA	5.5V/40mA
12V/27mA	14V/35mA
15V/24mA	16.5V/28mA
24V/17mA	26V/20mA
28V/16.5mA	30V/18mA
48V/15mA	50V/16mA
60V/9mA	65V/10mA
120VAC/3.5mA	130VAC/4mA

3 Voltage ^[6]
2
5H
12H
15H
24H
28H
48H
60H
120 ^[9]

MEDIUM INTENSITY - TINTED ENCAPSULATION					
LED	Color	λpk (nm)	Iv ^[3] (mcd)	Viewing Angle	V/C Table ^[5]
-BCR	RED	635	120	35	I
-BCA	AMB	583	100	35	I
-BCG	GRN	565	80	24	I

Voltage/Current	
Design Vf/If	Max Vf/If
V/C Table II	
5V/15mA	6V/26mA
12V/15mA	14V/20mA
15V/15mA	16.5V/18mA
24V/15mA	26V/18mA
28V/15mA	30V/17mA
48V/9.5mA	50V/10mA
60V/7mA	65V/8mA
120VAC/3.5mA	130VAC/4mA

4 Lens Diffusion
-C Clear
-N Diffused

HIGH INTENSITY - WATERCLEAR ENCAPSULATION					
LED	Color	λpk (nm)	Iv ^[3] (mcd)	Viewing Angle	V/C Table ^[5]
-NWR	RED	634	5300	30	I
-NWO	ORG	605	2000	30	I
-NWA	AMB	592	5300	30	I
-NWG	GRN	520	2400	45	II
-NWB	BLU	465	700	45	II
-NWW ^[8]	WHT	^[4]	1560	50	II
-NKR	RED	634	6900	15	I
-NKO	ORG	605	8000	15	I
-NKA	AMB	592	6900	15	I
-NKG	GRN	520	10000	15	II
-NKB	BLU	465	3000	15	II
-NKW ^[8]	WHT	^[4]	5600	20	II

5 Lens Color	
R Red	B Blue
A Amber	W Water Clear
Y Yellow	
G Green	-S Smoke ^[10]

SPECIALTY LEDs - DIFFUSED ENCAPSULATION						
LED	Color	λpk (nm)	Iv ^[3] (mcd)	Viewing Angle	V/C Table ^[5]	Description
-RLP ^[7]	RED	635	2.3	50	[5]	Low Power
-ALP ^[7]	AMB	583	2.1	50	[5]	Low Power
-GLP ^[7]	GRN	565	2.3	50	[5]	Low Power
-LRG ^[8]	RED/GRN	660/565	90/40	60	I	Bi-Color, Red Cathode

6 Bezel Color
0 Black
9 White

[1] The C option specifies a pin length = .20" for panel lights mounted in the PS90 or PS90T socket (pg. 54). Mounting hardware is included with the socket. Do not select the W option. C and standard pins are not solderable.

[2] Model 905 has no lens. Omit Lens Diffusion and Color (e.g. 905-BG5H-0).

[3] Iv = typical luminous intensity @ If = 20mA (Ta = 25°C). Iv is measured without lenses. For Low Power LEDs, If = 2mA.

[4] White is identified by one of four CIE coordinates x:0.290/y:0.260, x:0.290/y:0.305, x:0.330/y:0.365, x:0.330/y:0.320

[5] See Voltage/Current table for design specifications. Design current for low power LEDs = 2mA.

[6] Ta = 25°C. Voltage "2" indicates external resistor required. Voltages 5H through 60H are VDC. For AC operation, insert D after Voltage (e.g. 24HD). D indicates built-in rectifier; not required for 15H or less, or 120VAC. DC operation not available for 120V. Bi-Color not available in AC voltages.

[7] Omit H when selecting a voltage (e.g. 91-RLP12-CW0).

[8] Select -CW or -NW Lens only.

[9] Select high intensity LEDs only.

[10] Omit Lens Diffusion when selecting smoked lens (e.g. 91-NWG24H-S0).

905 (no lens)

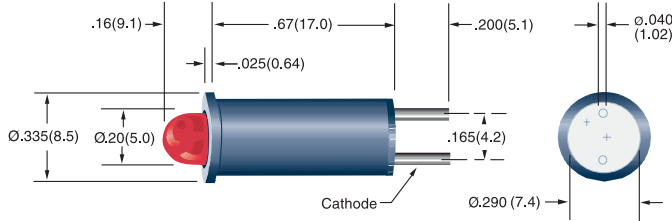

91

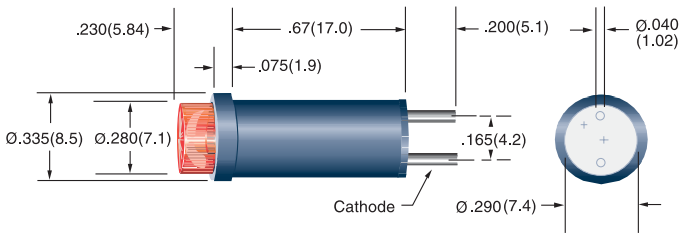

94 (flush lens)

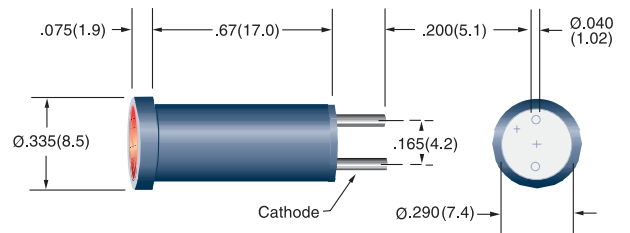

96

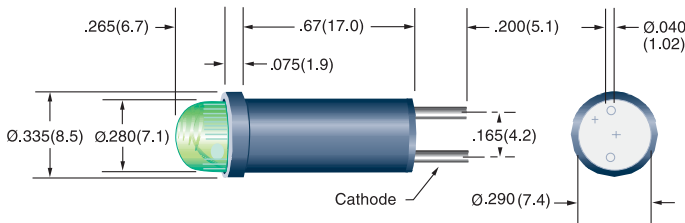

961

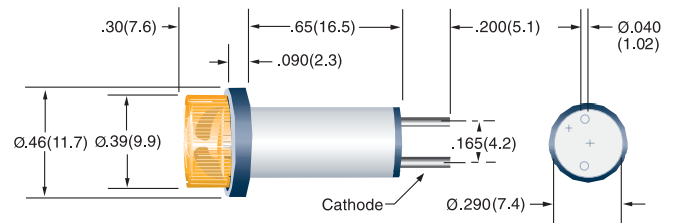

964

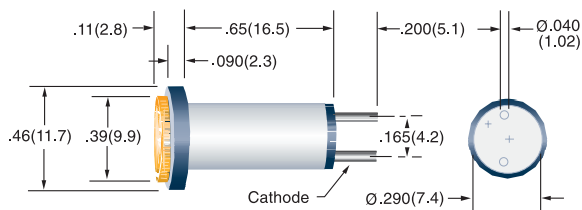

TC9 & NW9 Mounting Hardware

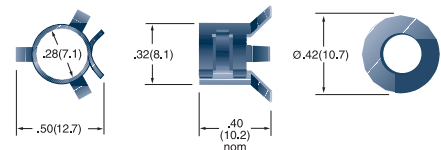

Standard Wire Leads:

6.0" total length(nominal)/.50" stripped (nominal), red anode/black cathode, 24 AWG TPB UL1061 insulation. Contact factory for other lengths, gauges and colors.

All dimensions are in inches (mm)

Tolerances: .xx"(.x) ±.025"(.63) / .xxx"(.xx)±.010"(.25)
Specifications are subject to change without notice.

.290" MOUNT PANEL LIGHT SOCKETS

90 Series Mounting Hardware

- Sockets for 90 Series Panel Lights

TO ORDER, FOLLOW THE EXAMPLE:

Select one **BOLD** component from each SHADED column in the tables below.

1 Model	2 Lens Diffusion	3 Lens Color
L92	-C	R

→ Part Number **L92-CR**

90 SERIES SOCKETS & HARDWARE

1 Model	Description	Mating Components
PS90 ^[1]	90 Series Socket, Solder Terminals	C905, C91, C94, C96, C961, C964
PS90T ^[1]	90 Series Socket, Turret Terminals	C905, C91, C94, C96, C961, C964
RC90	Retaining Collar	PS90, PS90T
SH90	Wiring Plug	905, 91, 94, 96, 961, 964, C905, C91, C94, C96, C961, C964
CSH90	Wiring Plug with collar	905, 91, 94, 96, 961, 964, C905, C91, C94, C96, C961, C964
TC9	90 Series Mounting Clip	905, 91, 94, 96, 961, 964, C905, C91, C94, C96, C961, C964
NW9	90 Series Mounting Washer (neoprene)	905, 91, 94, 96, 961, 964, C905, C91, C94, C96, C961, C964

90 SERIES LENS

(For use with PS90 or PS90T Socket with Model C905 Panel Light)

1 Model	2 Lens Diffusion	3 Lens Color
L92	-C Clear	R Red
	-N Diffused	A Amber
		Y Yellow
		G Green
		B Blue
		W Water Clear
		-S Smoke ^[2]



[1] Hardware Assembled.

[2] Omit Lens Diffusion Code (e.g. L92-S).

PS90

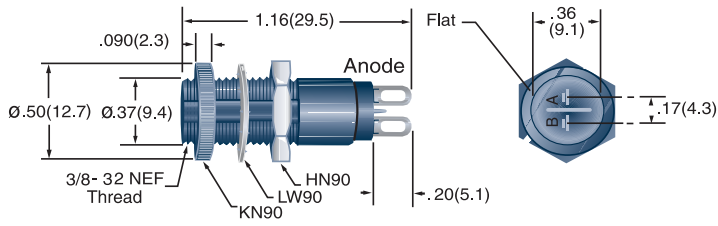

PS90T

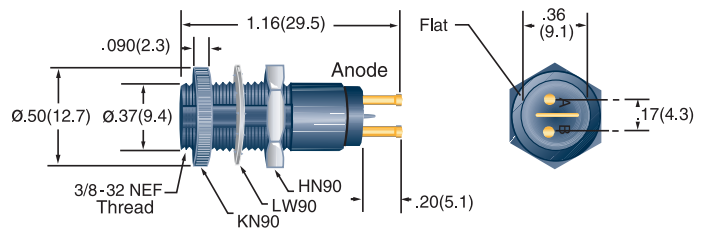

SH90

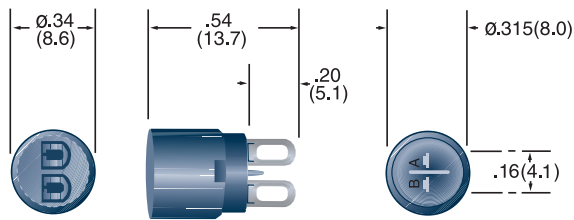

CSH90

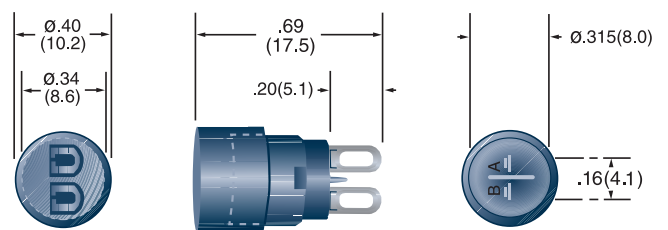

RC90-B

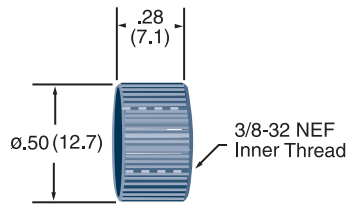

L92

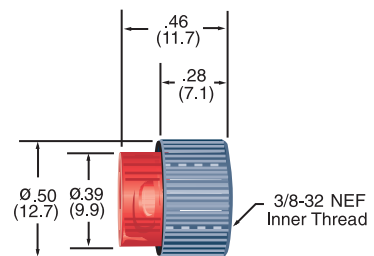

TC9 & NW9 Mounting Hardware

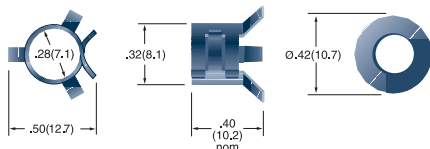

All dimensions are in inches (mm)

Tolerances: $.xx(.x) \pm .025"(.63)$ / $.xxx(.xx) \pm .010"(.25)$

Specifications are subject to change without notice.

.290" MOUNT PANEL LIGHT SOCKETS

Water-Tight

- Sockets for model C905 - For Splash Down Environments (not submersible)

1 Socket Model

PS90
PS90T

2 Lens Model

-L92

3 Lens Diffusion

-C
Clear

-N
Diffused

4 Lens Color

R Red	B Blue
A Amber	W Water Clear
Y Yellow	-S Smoke ^[1]
G Green	

5 Water Tight

-WT

TO ORDER, FOLLOW THE EXAMPLE:

Select one **BOLD** component from each numbered category in the tables below.

1	2	3	4	5
Socket Model	Lens Model	Lens Diffusion	Lens Color	Water Tight
PS90	-L92	-C	-Y	-WT

→Part Number **PS90T-L92-CY-WT**



PS90, Water Tight

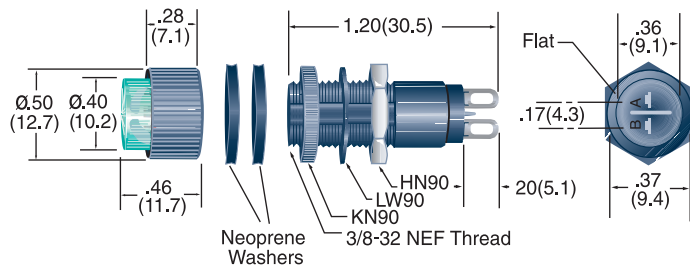

PS90T, Water Tight

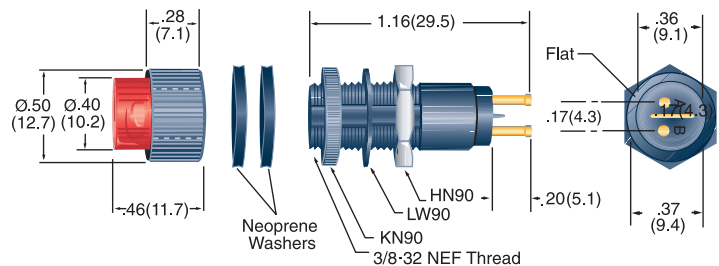

[1] Omit Lens Diffusion Code (e.g. PS90T-L92-S-WT).

All dimensions are in inches (mm)

Tolerances: .xx"(.x) ±.025"(.63) / .xxx"(.xx)±.010"(.25)
Specifications are subject to change without notice.

PRODUCT SELECTION WIZARD



Data Display Products®

Our menu-driven product selection guide is available at www.datadisplay.com.

You can assemble a part number and request a sample based on your application criteria.

.312" MOUNT PANEL LIGHTS



Data Display Products®

50 Series

- Mounting Hardware Provided - For Detailed LED Data, See Discrete Section, MODEL 200

1 Model	Wires
51	W
53 ^[1]	(optional)
54	
56	
561	
564	

TO ORDER, FOLLOW THE EXAMPLE:

Select one **BOLD** component from each numbered category in the tables below.

1 Model	2 LED	3 Voltage	4 Lens Diffusion	5 Lens Color	6 Bezel Color
54	-ALP	2	-C	A	9

→ Part Number **54-ALP2-CA9**

MEDIUM INTENSITY - TINTED ENCAPSULATION					
2 LED	Color	λpk (nm)	Iv ^[2] (mcd)	Viewing Angle	V/C Table ^[3]
-BCR	RED	635	120	35	I
-BCA	AMB	583	100	35	I
-BCG	GRN	565	80	24	I

Voltage/Current	
Design Vf/If	Max Vf/If
V/C Table I	
5V/27mA	5.5V/40mA
12V/27mA	14V/35mA
15V/24mA	16.5V/28mA
24V/17mA	26V/20mA
28V/16.5mA	30V/18mA
48V/15mA	50V/16mA
60V/9mA	65V/10mA
120VAC/3.5mA	130VAC/4mA

3 Voltage ^[4]
2
5H
12H
15H
24H
28H
48H
60H
120 ^[5]

HIGH INTENSITY - WATERCLEAR ENCAPSULATION					
LED	Color	λpk (nm)	Iv ^[2] (mcd)	Viewing Angle	V/C Table ^[3]
-NWR	RED	634	5300	30	I
-NWO	ORG	605	2000	30	I
-NWA	AMB	592	5300	30	I
-NWG	GRN	520	2400	45	II
-NWB	BLU	465	700	45	II
-NWW^[7]	WHT	[9]	1560	50	II
-NKR	RED	634	6900	15	I
-NKO	ORG	605	8000	15	I
-NKA	AMB	592	6900	15	I
-NKG	GRN	520	10000	15	II
-NKB	BLU	465	3000	15	II
-NKW^[7]	WHT	[9]	5600	20	II

Voltage/Current	
Design Vf/If	Max Vf/If
V/C Table II	
5V/15mA	6V/26mA
12V/15mA	14V/20mA
15V/15mA	16.5V/18mA
24V/15mA	26V/18mA
28V/15mA	30V/17mA
48V/9.5mA	50V/10mA
60V/7mA	65V/8mA
120VAC/3.5mA	130VAC/4mA

4 Lens Diffusion
-C
Clear
-N
Diffused

5 Lens Color	
R Red	B Blue
A Amber	W Water Clear
Y Yellow	
G Green	-S Smoke ^[8]

SPECIALTY LEDs						
LED	Color	λpk (nm)	Iv ^[2] (mcd)	Viewing Angle	V/C Table ^[3]	Description
-RLP^[6]	RED	635	2.3	50	[3]	Low Power
-ALP^[6]	AMB	583	2.1	50	[3]	Low Power
-GLP^[6]	GRN	565	2.3	50	[3]	Low Power
-LRG^[7]	RED/GRN	660/565	90/40	60	I	Bi-Color, Red Cathode
-RAG^[7]	RED/AMB/GRN	630/565	6/6/6	60	I	Tri-Color, Common Cathode
-GAR^[7]	GRN/AMB/RED	635/565	5/5/5	50	I	Tri-Color, Common Anode

6 Bezel Color
0
Black
9
White

[1] Model 53 is available with Clear (-C) Lens only.

[2] Iv = typical luminous intensity @ If = 20mA (Ta = 25°C). Iv is measured without lenses. For Low Power LEDs, If = 2mA.

[3] See Voltage/Current table for design specifications. Design current for low power LEDs = 2mA.

[4] Ta = 25°C. Voltage 2 indicates external resistor required. Voltages 5H through 60H are VDC.

[5] For AC operation, insert D after Voltage (e.g. 24HD), D indicates built-in rectifier; not required for 15H or less, or 120VAC. DC operation not available for 120V. Bi-Color and Tri-Color not available in AC voltages.

[6] Select high intensity LEDs only.

[7] Omit H when selecting a voltage (e.g. 51-RLP12-CW0).

[8] Select -CW or -NW lens only. -RAG wire leads: green anode/black cathode/red anode. -GAR wire leads: green cathode/black anode/red cathode. Common lead is the first lead clockwise from reference mark on header. Tri-Color 5 or 12 volt, omit H in part number.

[9] Omit Lens Diffusion when selecting smoked lens (e.g. 51-NWA12H-S0).

[9] White is identified by one of four CIE coordinates x:0.290/y:0.260, x:0.290/y:0.305, x:0.330/y:0.365, x:0.330/y:0.320

51

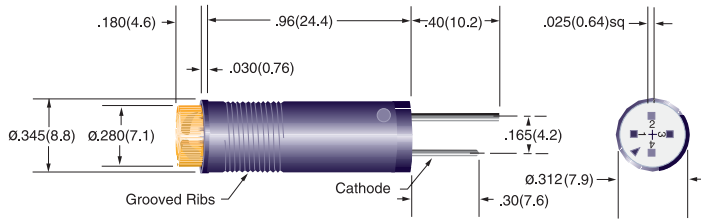

53

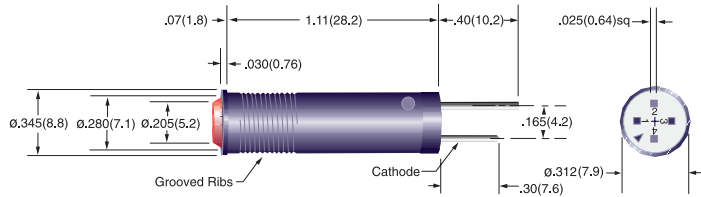

54 (flush lens)

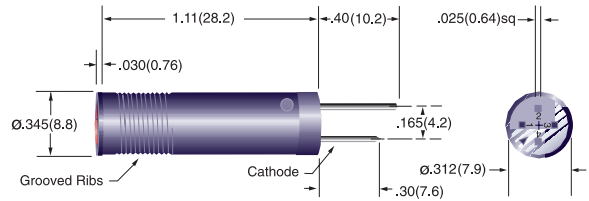

56

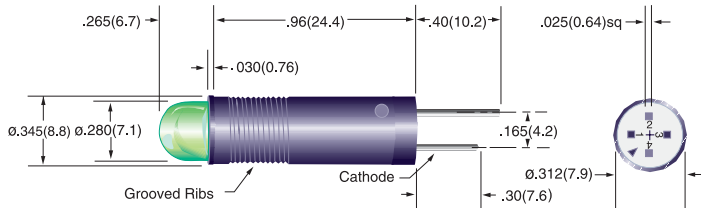

561

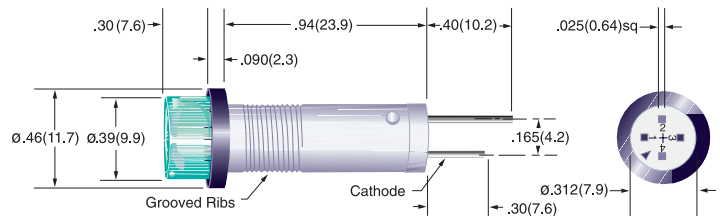

564

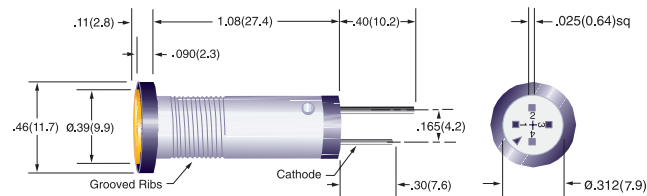

TC5 & NW5 Mounting Hardware

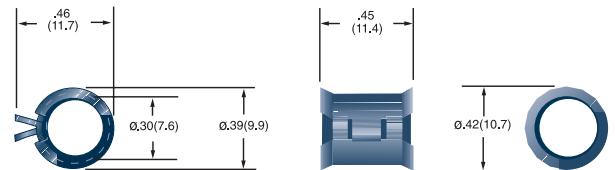

Standard Wire Leads:

6.0" total length(nominal)/.50" stripped (nominal), red anode/black cathode, 24 AWG TPB UL1061 insulation. Contact factory for other lengths, gauges and colors.

All dimensions are in inches (mm)

Tolerances: .xx"(.x) $\pm .025$ "(.63) / .xxx"(.xx) $\pm .010$ "(.25)
Specifications are subject to change without notice.

.230" PANEL MOUNT REFLECTOR



Data Display Products®

T-1, Water-Tight Optional

- Reflective Nickel-Plated Body - Mounting Hardware Provided - Maximum Panel Thickness .125"(PMRL125); .070"(PMRL125, Water-Tight)
- For Detailed LED Data, See Discrete Section, MODEL 125

1	Model	Wires
	PMRL125	W (optional)

TO ORDER, FOLLOW THE EXAMPLE:

Select one **BOLD** component from each numbered category in the tables below.

1	Model	Wire	2	LED	3	Voltage	4	Water Tight
	PMRL125	W		-BCG		12H		

→Part Number **PMRL125W-BCG12H**

STANDARD INTENSITY - DIFFUSED ENCAPSULATION						
2	LED	Color	λ_{pk} (nm)	$I_v^{[1]}$ (mcd)	Viewing Angle	V/C Table ^[2]
	-BR	RED	635	14	60	I
	-BA	AMB	583	14	60	I
	-BG	GRN	565	14	60	I

MEDIUM INTENSITY - TINTED ENCAPSULATION						
2	LED	Color	λ_{pk} (nm)	$I_v^{[1]}$ (mcd)	Viewing Angle	V/C Table ^[2]
	-BCR	RED	635	60	45	I
	-BCA	AMB	583	30	45	I
	-BCG	GRN	565	44	45	I

HIGH INTENSITY - WATERCLEAR ENCAPSULATION						
2	LED	Color	λ_{pk} (nm)	$I_v^{[1]}$ (mcd)	Viewing Angle	V/C Table ^[2]
	-NWR	RED	634	3200	35	I
	-NWA	AMB	592	2500	35	I
	-NWG	GRN	520	2000	45	II
	-NWB	BLU	465	600	45	II
	-NWW	WHT	[7]	1100	55	II

Voltage/Current	
Design Vf/If	Max Vf/If
V/C Table I	
5V/27mA	5.5V/40mA
12V/27mA	14V/35mA
15V/24mA	16.5V/28mA
24V/17mA	26V/20mA
28V/16.5mA	30V/18mA
48V/15mA	50V/16mA
60V/9mA	65V/10mA
120VAC/3.5mA	130VAC/4mA

Voltage/Current	
Design Vf/If	Max Vf/If
V/C Table II	
5V/15mA	6V/26mA
12V/15mA	14V/20mA
15V/15mA	16.5V/18mA
24V/15mA	26V/18mA
28V/15mA	30V/17mA
48V/9.5mA	50V/10mA
60V/7mA	65V/8mA
120VAC/3.5mA	130VAC/4mA

3	Voltage ^[3]
	2
	5H
	12H
	15H
	24H
	28H
	48H
	60H
	120 ^[4]

4	Water Tight ^[5]
	-WT (optional)

SPECIALTY LEDs - DIFFUSED ENCAPSULATION						
LED	Color	λ_{pk} (nm)	$I_v^{[1]}$ (mcd)	Viewing Angle	V/C Table ^[2]	Description
-RLP ^[6]	RED	635	2.1	50	[2]	Low Power
-ALP ^[6]	AMB	583	1.6	50	[2]	Low Power
-GLP ^[6]	GRN	565	2.1	50	[2]	Low Power
-RG	RED/GRN	630/565	5.0/5.0	72	I	Bi-Color, Red Cathode

[1] I_v = typical luminous intensity @ $I_f = 20mA (T_a = 25^\circ C)$. For Low Power LEDs, $I_f = 2mA$.

[2] See Voltage/Current table for design specifications. Design current for low power LEDs = 2mA.

[3] $T_a = 25^\circ C$. Voltage "2" indicates external resistor required. Voltages 5H through 60H are VDC. For AC operation, insert D after Voltage (e.g. 24HD). D indicates built-in rectifier, not required for 15H or less, or 120VAC. DC operation not available for 120VAC. Bi-Color not available in AC voltages.

[4] Select high intensity LEDs only.

[5] Drip-proof (not submersible), supplied with two neoprene gaskets.

[6] Omit H when selecting a voltage (e.g. PMRL125-RLP12).

[7] White is identified by one of four CIE coordinates x:0.29/y:0.23, x:0.29/y:0.27, x:0.32/y:0.32, x:0.32/y:0.28.



PMRL125

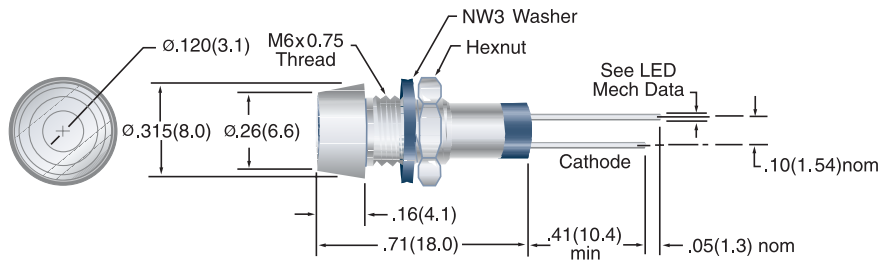

Standard Wire Leads:

6.0" total length(nominal)/.50" stripped (nominal), red anode/black cathode, 24 AWG TPB UL1061 insulation. Contact factory for other lengths, gauges and colors.

All dimensions are in inches (mm)

Tolerances: .xx"(.x) $\pm.025"$ (.63) / .xxx"(.xx) $\pm.010"$ (.25)
Specifications are subject to change without notice.

.312" PANEL MOUNT REFLECTOR



Data Display Products®

T-1³/₄, Water-Tight Optional

- Reflective Nickel-Plated Body - Mounting Hardware Provided - Maximum Panel Thickness .160"(PMRL200); .100"(PMRL200, Water-Tight)
 - For Detailed LED Data, See Discrete Section, MODEL 200

1 Model	Wires
PMRL200	W (optional)

TO ORDER, FOLLOW THE EXAMPLE:

Select one **BOLD** component from each numbered category in the tables below.

1 Model	Wire	2 LED	3 Voltage	4 Water Tight
PMRL200	W	-BCA	12H	

→Part Number **PMRL200W-BCA12H**

STANDARD INTENSITY - DIFFUSED ENCAPSULATION					
2 LED	Color	λpk (nm)	Iv ^[1] (mcd)	Viewing Angle	V/C Table ^[3]
-BR	RED	635	14	60	I
-BA	AMB	583	16	60	I
-BG	GRN	565	10	60	I

MEDIUM INTENSITY - TINTED ENCAPSULATION					
LED	Color	λpk (nm)	Iv ^[1] (mcd)	Viewing Angle	V/C Table ^[3]
-BCR	RED	635	120	35	I
-BCA	AMB	583	100	35	I
-BCG	GRN	565	80	24	I

HIGH INTENSITY - WATERCLEAR ENCAPSULATION					
LED	Color	λpk (nm)	Iv ^[1] (mcd)	Viewing Angle	V/C Table ^[3]
-NWR	RED	634	5300	30	I
-NWO	ORG	605	2000	30	I
-NWA	AMB	592	5300	30	I
-NWG	GRN	520	2400	45	II
-NWB	BLU	465	700	45	II
-NWW	WHT	[2]	1560	50	II
-NKR	RED	634	6900	15	I
-NKO	ORG	605	8000	15	I
-NKA	AMB	592	6900	15	I
-NKG	GRN	520	10000	15	II
-NKB	BLU	465	3000	15	II
-NKW	WHT	[2]	5600	20	II

Voltage/Current	
Design Vf/If	Max Vf/If
V/C Table I	
5V/27mA	5.5V/40mA
12V/27mA	14V/35mA
15V/24mA	16.5V/28mA
24V/17mA	26V/20mA
28V/16.5mA	30V/18mA
48V/15mA	50V/16mA
60V/9mA	65V/10mA
120VAC/3.5mA	130VAC/4mA

Voltage/Current	
Design Vf/If	Max Vf/If
V/C Table II	
5V/15mA	6V/26mA
12V/15mA	14V/20mA
15V/15mA	16.5V/18mA
24V/15mA	26V/18mA
28V/15mA	30V/17mA
48V/9.5mA	50V/10mA
60V/7mA	65V/8mA
120VAC/3.5mA	130VAC/4mA

3 Voltage ^[4]
2
5H
12H
15H
24H
28H
48H
60H
120 ^[5]

4 Water Tight ^[6]
-WT (optional)

SPECIALTY LEDs - DIFFUSED ENCAPSULATION						
LED	Color	λpk (nm)	Iv ^[1] (mcd)	Viewing Angle	V/C Table ^[3]	Description
-RLP ^[7]	RED	635	2.3	50	[3]	Low Power
-ALP ^[7]	AMB	583	2.1	50	[3]	Low Power
-GLP ^[7]	GRN	565	2.3	50	[3]	Low Power
-LRG	RED/GRN	660/565	90/40	60	I	Bi-Color, Green Cathode
-RAG ^[8]	RED/AMB/GRN	630/565	6/6/6	60	I	Tri-Color, Common Cathode
-GAR ^[8]	GRN/AMB/RED	635/565	5/5/5	50	I	Tri-Color, Common Anode

[1] Iv = typical luminous intensity @ If = 20mA (Ta = 25°C). For Low Power LEDs, If = 2mA.

[2] White is identified by one of four CIE coordinates x:0.290/y:0.260, x:0.290/y:0.305, x:0.330/y:0.365, x:0.330/y:0.320

[3] See Voltage/Current table for design specifications. Design current for low power LEDs = 2mA.

[4] Ta = 25°C. Voltage "2" indicates external resistor required. Voltages 5H through 60H are VDC. For AC operation, insert D after Voltage (e.g. 24HD). D indicates built-in rectifier, not required for 15H or less, or 120VAC. DC operation not available for 120V. Bi-Color and Tri-Color not available in AC voltages.

[5] Select high intensity LEDs only

[6] Drip-proof (not submersible), supplied with two neoprene gaskets.

[7] Omit H when selecting a voltage (e.g. PMR200-RLP12).

[8] -RAG Wire Leads: green anode/black cathode/red anode. -GAR Wire Leads: green cathode/black anode/red cathode. Tri-Color 5 or 12 volt, omit H from part number.



PMRL200

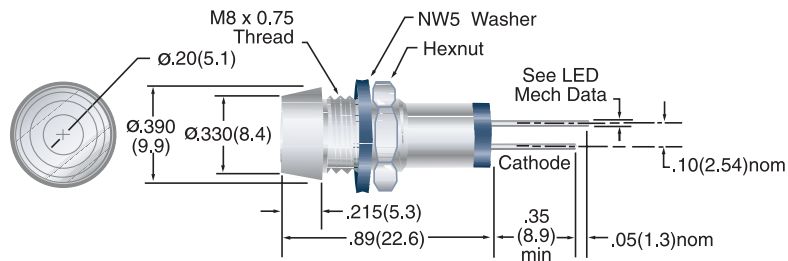

Standard Wire Leads:

6.0" total length(nominal)/.50" stripped (nominal), red anode/black cathode, 24 AWG TPB UL1061 insulation. Contact factory for other lengths, gauges and colors.

All dimensions are in inches (mm)

Tolerances: .xx"(.x) ±.025"(.63) / .xxx"(.xx)±.010"(.25)
Specifications are subject to change without notice.

.312" MOUNT PANEL LIGHT



Data Display Products®

74S Series

- Black Anodized Aluminum Body - For Detailed LED Data, See Discrete Section, Model 200

1	Model	Wires
	74S	W (optional)

TO ORDER, FOLLOW THE EXAMPLE:

Select one **BOLD** component from each numbered category in the tables below.

1	Model	2	LED	3	Voltage	4	Lens Diffusion	5	Lens Color
	74S		-NWR		120		-C		R

→Part Number **74S-NWR120-CR**

HIGH INTENSITY - WATERCLEAR ENCAPSULATION						
2	LED	Color	λ_{pk} (nm)	$I_v^{[1]}$ (mcd)	Viewing Angle	V/C Table ^[3]
	-NWR	RED	634	5300	30	I
	-NWO	ORG	605	2000	30	I
	-NWA	AMB	592	5300	30	I
	-NWG	GRN	520	2400	45	II
	-NWB	BLU	465	700	45	II
	-NWW	WHT	[2]	1560	50	II

Voltage/Current	
Design Vf/If	Max Vf/If
V/C Table I	
5V/27mA	5.5V/40mA
12V/27mA	14V/35mA
15V/24mA	16.5V/28mA
24V/17mA	26V/20mA
28V/16.5mA	30V/18mA
48V/15mA	50V/16mA
60V/9mA	65V/10mA
120VAC/3.5mA	130VAC/4mA

3	Voltage^[4]
	2
	5H
	12H
	15H
	24H
	28H
	48H
	60H
	120

Voltage/Current	
Design Vf/If	Max Vf/If
V/C Table II	
5V/15mA	6V/26mA
12V/15mA	14V/20mA
15V/15mA	16.5V/18mA
24V/15mA	26V/18mA
28V/15mA	30V/17mA
48V/9.5mA	50V/10mA
60V/7mA	65V/8mA
120VAC/3.5mA	130VAC/4mA

4	Lens Diffusion
	-C Clear

5	Lens Color		
R	Red	G	Green
A	Amber	W	Water Clear
Y	Yellow		

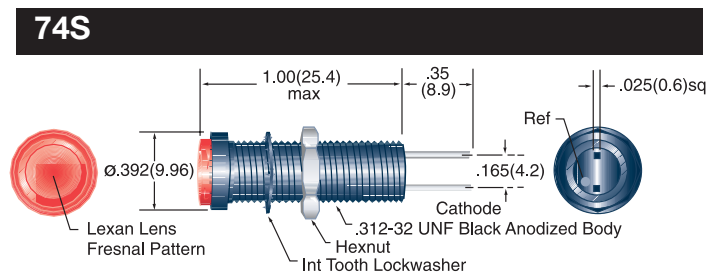

[1] I_v = typical luminous intensity @ $I_f = 20mA (T_a = 25^\circ C)$. I_v is measured without lenses.

[2] White is identified by one of four CIE coordinates x:0.290/y:0.260, x:0.290/y:0.305, x:0.330/y:0.365, x:0.330/y:0.320

[3] See Voltage/Current table for design specifications.

[4] $T_a = 25^\circ C$. Voltages 5H through 60H are VDC. For AC operation, insert D after Voltage (e.g. 24HD), D indicates built-in rectifier; not required for 15H or less, or 120VAC. DC operation not available for 120V.

Standard Wire Leads:

6.0" total length(nominal)/.50" stripped (nominal), red anode/black cathode, 24 AWG TPB UL1061 insulation. Contact factory for other lengths, gauges and colors.

All dimensions are in inches (mm)

Tolerances: .xx"(.) \pm .025"(.63) / .xxx"(.) \pm .010"(.25)
Specifications are subject to change without notice.

- For Detailed LED Data, See Discrete Section, Model 200

1	Model	Wires
	P81 P84	W (optional)

TO ORDER, FOLLOW THE EXAMPLE:

Select one **BOLD** component from each numbered category in the tables below.

1	Model	2	LED	3	Voltage	4	Lens
	P81		-G		24		-CG

→Part Number **P81-G24-CG**

HIGH INTENSITY - WATERCLEAR ENCAPSULATION

2	LED	Color	λpk (nm)	Iv^[1] (mcd)	Viewing Angle	V/C Table^[3]
	-R	RED	634	5300	30	I
	-O	ORG	605	2000	30	I
	-A	AMB	592	5300	30	I
	-G	GRN	520	2400	45	II
	-B	BLU	465	700	45	II
	-W	WHT	[2]	1560	50	II

Voltage/Current	
Design Vf/If	Max Vf/If
V/C Table I	
5V/27mA	5.5V/40mA
6V/26mA	7V/33mA
12V/27mA	14V/35mA
15V/24mA	16.5V/28mA
24V/17mA	26V/20mA
28V/16.5mA	30V/18mA
48V/15mA	50V/16mA
60V/9mA	65V/10mA
120VAC/3.5mA	130VAC/4mA

3	Voltage^[4]
	5H
	6H
	12H
	15H
	24H
	28H
	48H
	60H
	120

P81

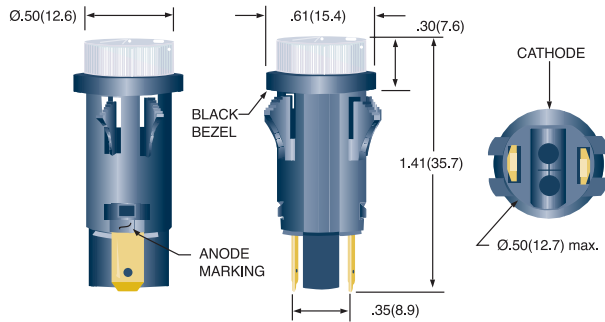

Voltage/Current	
Design Vf/If	Max Vf/If
V/C Table II	
5V/15mA	6V/26mA
6V/15mA	7V/25mA
12V/15mA	14V/20mA
15V/15mA	16.5V/18mA
24V/15mA	26V/18mA
28V/15mA	30V/17mA
48V/9.5mA	50V/10mA
60V/7mA	65V/8mA
120VAC/3.5mA	130VAC/4mA

4	Lens
-CR	Red
-CA	Amber
-CG	Green
-CB	Blue
-CW	Water Clear

P84

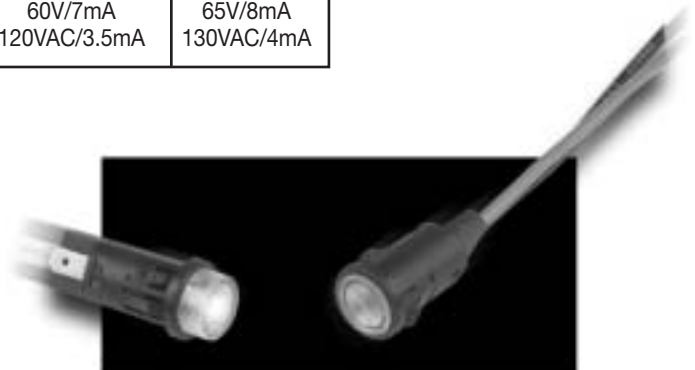
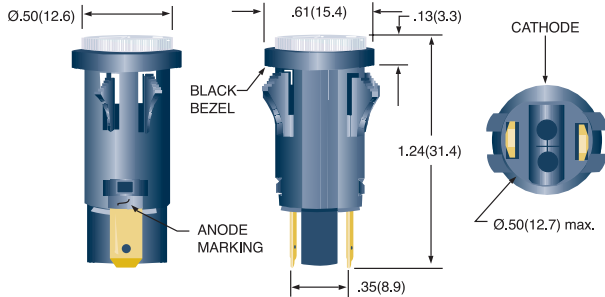

[1] Iv = typical luminous intensity @ If = 20mA (Ta=25°C). Iv is measured without lenses.

[2] White is identified by one of four CIE coordinates x:0.290/y:0.260, x:0.290/y:0.305, x:0.330/y:0.365, x:0.330/y:0.320

[3] See Voltage/Current table for design specifications.

[4] Ta = 25°C. Voltages 5H through 60H are VDC. For AC operation, insert D after Voltage (e.g. 24HD), D indicates built-in rectifier; not required for 15H or less, or 120VAC. DC operation not available for 120V.

Standard Wire Leads:

6.0" total length(nominal)/.50" stripped (nominal), red anode/black cathode, 18 AWG TPB UL1015 insulation. Contact factory for other lengths, gauges and colors.

All dimensions are in inches (mm)

Tolerances: .xx"(.x) ±.025"(.63) / .xxx"(.xx)±.010"(.25)
Specifications are subject to change without notice.

17/32" MOUNT PANEL LIGHT WITH LENS



Data Display Products®

High Intensity, Wide Angle

1	Model
	1732

TO ORDER, FOLLOW THE EXAMPLE:

Select one **BOLD** component from each SHADED column in the tables below.

1	Model	2	LED	3	Voltage	4	Lens	5	Bi-Polar
	1732		-B		24		-CB		

→Part Number **1732-B24-CB**

2	LED	Color	λ_{pk} (nm)	I_v^[1] (mcd)	V/C Table^[2]
	-R	RED	634	3200	I
	-A	AMB	592	2500	I
	-G	GRN	520	2400	II
	-B	BLU	465	700	II
	-W	WHT	[4]	1560	II

Voltage/Current	
Design Vf/If	Max Vf/If
V/C Table I	
5V/27mA	5.5V/40mA
6V/26mA	7V/33mA
12V/27mA	14V/35mA
15V/24mA	16.5V/28mA
24V/17mA	26V/20mA
28V/16.5mA	30V/18mA
48V/15mA	50V/16mA
60V/9mA	65V/10mA
120VAC/3.5mA	130VAC/4mA

3	Voltage^[3]
	5
	6
	12
	15
	24
	28
	48
	60
	120



Voltage/Current	
Design Vf/If	Max Vf/If
V/C Table II	
5V/15mA	6V/26mA
6V/15mA	7V/25mA
12V/15mA	14V/20mA
15V/15mA	16.5V/18mA
24V/15mA	26V/18mA
28V/15mA	30V/17mA
48V/9.5mA	50V/10mA
60V/7mA	65V/8mA
120VAC/3.5mA	130VAC/4mA

4	Lens
	-CR Red
	-CA Amber
	-CG Green
	-CB Blue
	-CW Water Clear

1732

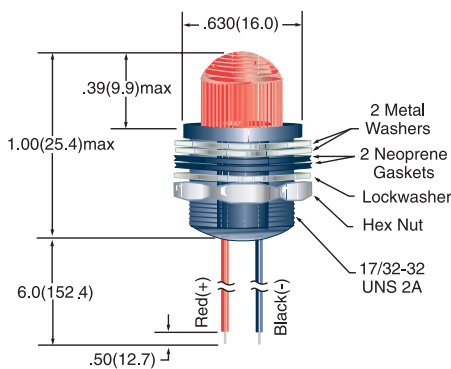

[1] I_v = typical luminous intensity @ I_f = 20mA (T_a = 25°C). Luminous intensity is measured without the lens.

[2] See Voltage/Current table for design specifications.

[3] T_a = 25°C. Voltages 5 through 60 are VDC. For AC operation, insert AC after Voltage (e.g. 24AC), not

required for 120V. Contact factory for VAC design currents. For 120VDC insert DC after Voltage (e.g. 120DC).

[4] White is identified by one of four CIE color coordinates x:0.290/y:0.260, x:0.290/y:0.305, x:0.330/y:0.365, x:0.330/y:0.320

Standard Wire Leads:

6.0" total length(nominal)/.50" stripped (nominal), red anode/black cathode, 18 AWG TPB UL1015 insulation. Contact factory for other lengths, gauges and colors.

All dimensions are in inches (mm)

Tolerances: .xx"(x) ±.025"(.63) / .xxx"(xx)±.010"(.25)
Specifications are subject to change without notice.

1	Model	Wires
	1116	W (optional)

TO ORDER, FOLLOW THE EXAMPLE:

Select one **BOLD** component from each numbered category in the tables below.

1	Model	2	LED	3	Voltage	4	Lens
	1116W		-R		12		-CW

→Part Number **1116W-R12-CW**

2	LED	Color	λ.pk (nm)	Iv^[1] (mcd)	V/C Table^[2]
	-R	RED	634	5300 (*4)	I
	-O	ORG	609	2000 (*4)	I
	-A	AMB	592	5300 (*4)	I
	-G	GRN	520	2400 (*2)	II
	-B	BLU	465	700 (*2)	II
	-W	WHT	[4]	1560 (*4)	II

Voltage/Current	
Design Vf/If	Max Vf/If
V/C Table I	
5V/75mA	5.5V/85mA
6V/40mA	7V/60mA
12V/30mA	14V/40mA
15V/30mA	16.5V/35mA
24V/30mA	26V/35mA
28V/25mA	30V/28mA
48V/20mA	52V/22mA
60V/16mA	65V/18mA
120VAC/9.5mA	130VAC/10.5mA

3	Voltage^[3]
	5
	6
	12
	15
	24
	28
	48
	60
	120

4	Lens
	-CW

1116

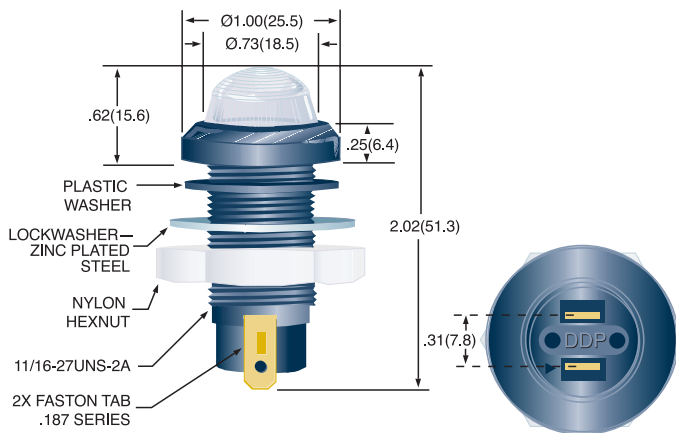

Voltage/Current	
Design Vf/If	Max Vf/If
V/C Table II	
5V/26mA	5.5V/35mA
6V/28mA	7V/39mA
12V/15mA	14V/22mA
15V/15mA	16.5V/19mA
24V/15mA	26V/18mA
28V/15mA	30V/18mA
48V/9mA	50V/9.5mA
60V/6.5mA	65V/7.2mA
120VAC/5mA	130VAC/5.5mA

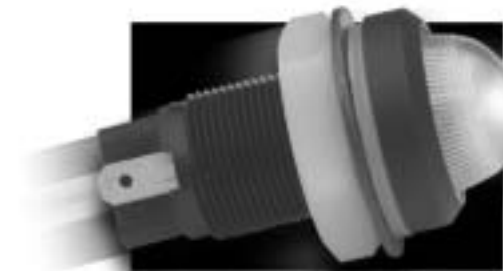

- [1] Iv = typical luminous intensity @ If = 20mA (Ta=25°C). (*4) = 4 LEDs per package; (*2) = 2 LEDs per package.
 [2] See Voltage/Current table for design specifications.
 [3] Ta = 25°C. Voltages 6 through 60 are VDC. For AC operation, insert D after Voltage (e.g. 24AC), not required for 120V. Contact factory for VAC design currents. For 120 VDC, insert DC after Voltage (e.g. 120DC).
 [4] White is identified by one of four CIE coordinates x:0.290/y:0.260, x:0.290/y:0.305, x:0.330/y:0.365, x:0.330/y:0.320

Standard Wire Leads:

6.0" total length(nominal)/.50" stripped (nominal), red anode/black cathode, 18 AWG TPB UL1015 insulation. Contact factory for other lengths, gauges and colors.

All dimensions are in inches (mm)

Tolerances: .xx"(x) ±.025"(.63) / .xxx"(xx)±.010"(.25)
 Specifications are subject to change without notice.