

THIS COPY IS PROVIDED ON A RESTRICTED BASIS AND IS NOT TO BE USED IN ANY WAY DETRIMENTAL TO THE INTERESTS OF PANDUIT CORP.

Material	High Conductivity Seamless Copper Tube
Plating	Electro-Tin
Wire Size	250 kcmil
Wire Type	Stranded Copper; Class B: Compact, Compressed or Concentric, Class C: Concentric
Wire Strip Length	1-11/16 in.
Stud Size	3/8 in.
UL Listed Wire Connector	Yes, for applications up to 35kv. Consult cable manufacturer for voltage stress relief instructions with applications greater than 2000 volts.
UL Temperature Rating	90° C
C.S.A Certified Wire Connector	Yes
Panduit Color Code on Barrel	YELLOW
Panduit Die Index No. on Barrel	P62
Alternate Industry Die Index No. ( ) on Barrel	(16)

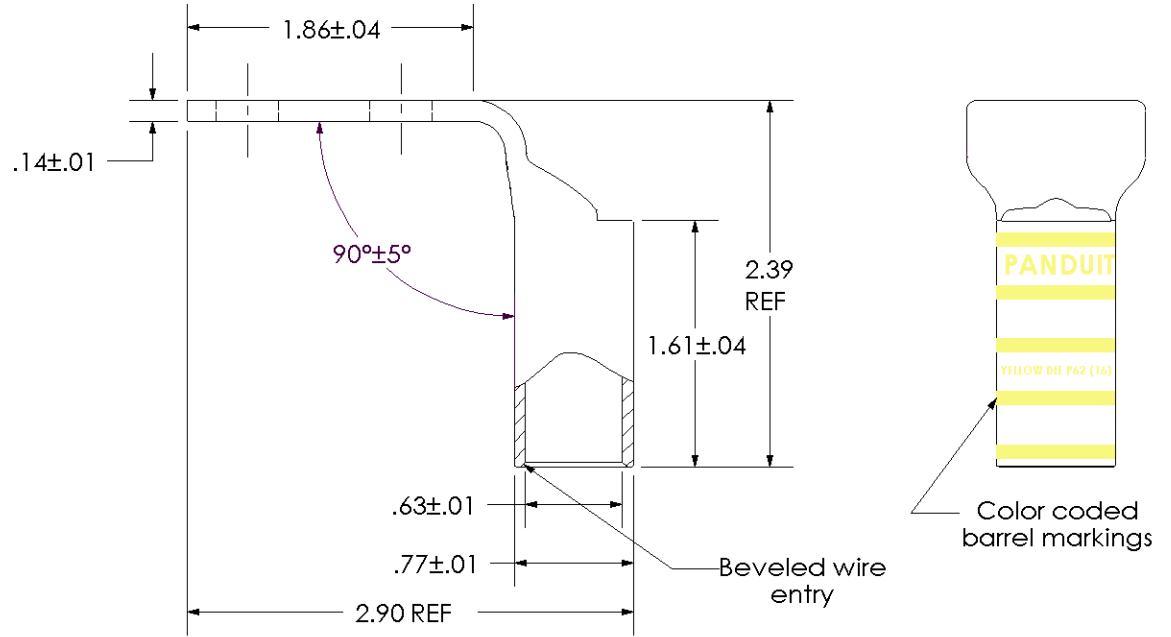
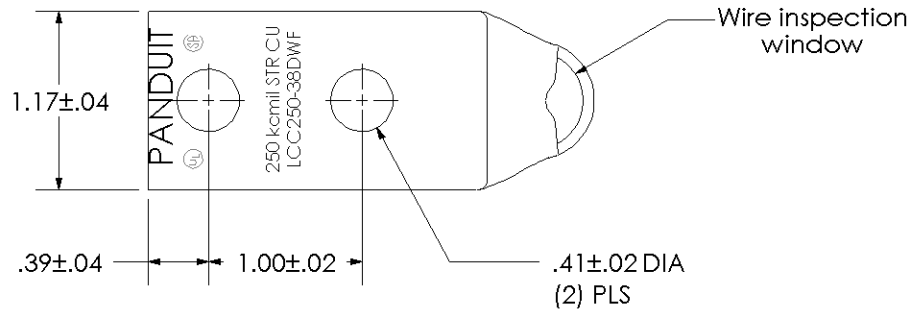

**PANDUIT CORP. TINLEY PARK, ILLINOIS**

LCC250-38DWF-X  
Copper Lug - Two-Hole, Long Barrel with Window, 90° Angle Tongue

00	9/02	SAB	DRL
REV	DATE	BY	CHK

RELEASED

10342

DESCRIPTION

ECN

SCALE  
N/A

DRAWING NO / CAD FILE

LCC250-38DWF-CUST