

NO.	MASSE / DIMENSION
A	1-20UNEF-2A
B	14.2
C	3.2
D	25.1
E	22.2
F	24.6
G	32.5
H	3.1

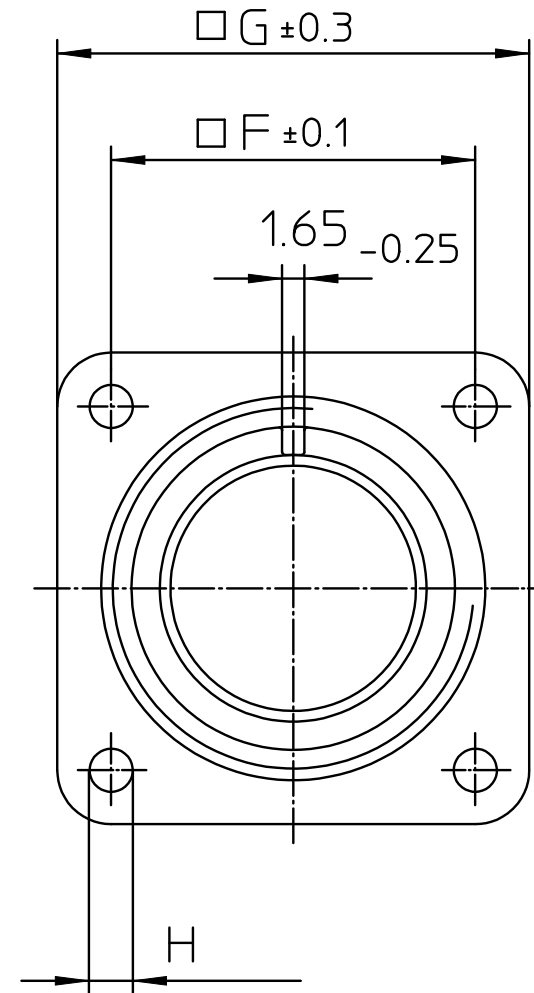

NO.	BESCHREIBUNG / DESCRIPTION
2	ISOLIERKÖRPER BUCHSE / INSULATOR SOCKET
6	KONTAKTBUCHSE / CONTACT SOCKET
8	DOSENGEHÄUSE / SHELL

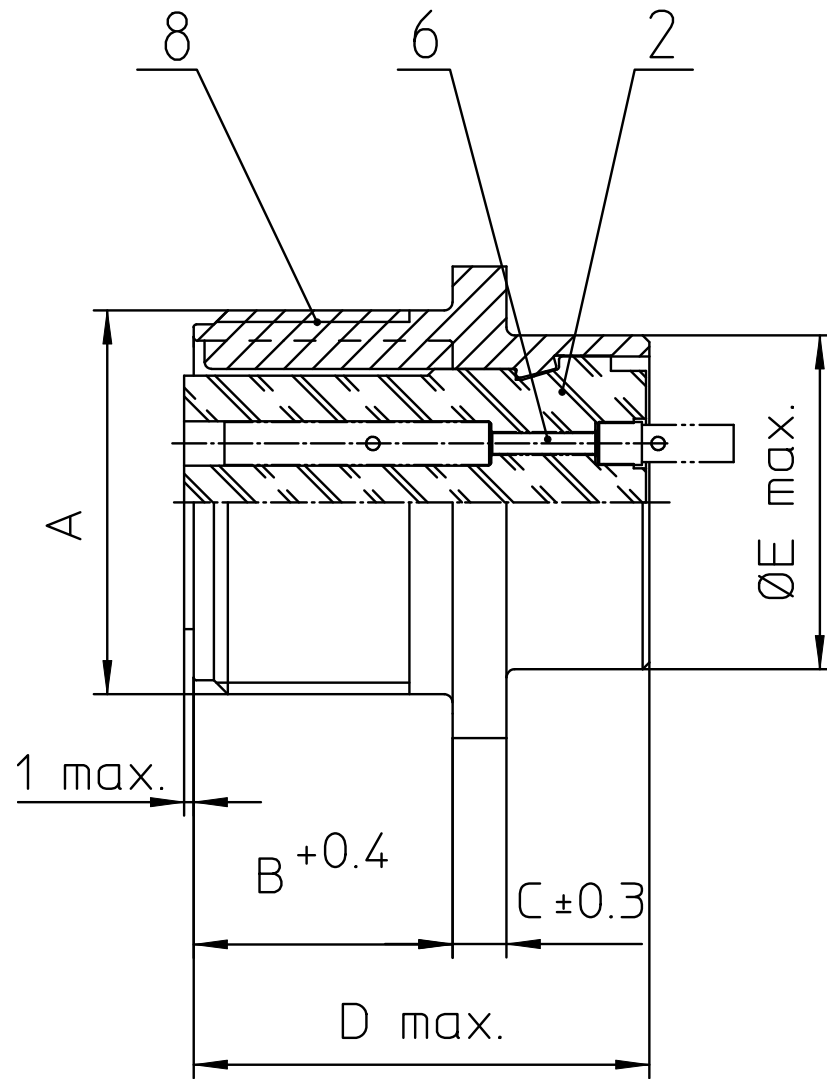
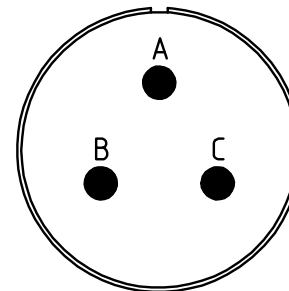

Note: Due to an automatic nomenclature system, numbers generated may not be sequential.
 Specification and Dimensions subject to change
 Drawings illustrate normal insulator positioning

Material Specification:
Shell Material: Aluminium alloy
Shell Plating: Olive drab chromate coating over cadmium plating
Insulator Material: Neoprene
Contact Material: Copper alloy
Contact Plating: Hard silver

all dimensions are in mm
 Dimensions without tolerance indications are general tolerances in acc. with DIN7168m

drawing for
 CUSTOMER



Engineered for life
 ITT CANNON GmbH
 D - 71384 Weinstadt/Germany

description CA3102E16S-5S
 Box mounting receptacle

Solder Cup / Socket / Layout: 16S-5

