

LISA2-M-CLIP

~20° medium beam optimized for CREE XP-E.
6.8 mm high variant with clip installation.

TECHNICAL SPECIFICATIONS:

Dimensions	Ø 9.9 mm
Height	6.8 mm
Fastening	glue, clips
Colour	black
Box size	
Box weight	1.4 kg
Quantity in Box	2000 pcs
ROHS compliant	yes ⓘ



MATERIAL SPECIFICATIONS:

Component	Type	Material	Colour
LISA2-M	Lens	PMMA	clear
LISA2-HLD-CLIP16-XP	Holder	PC	black

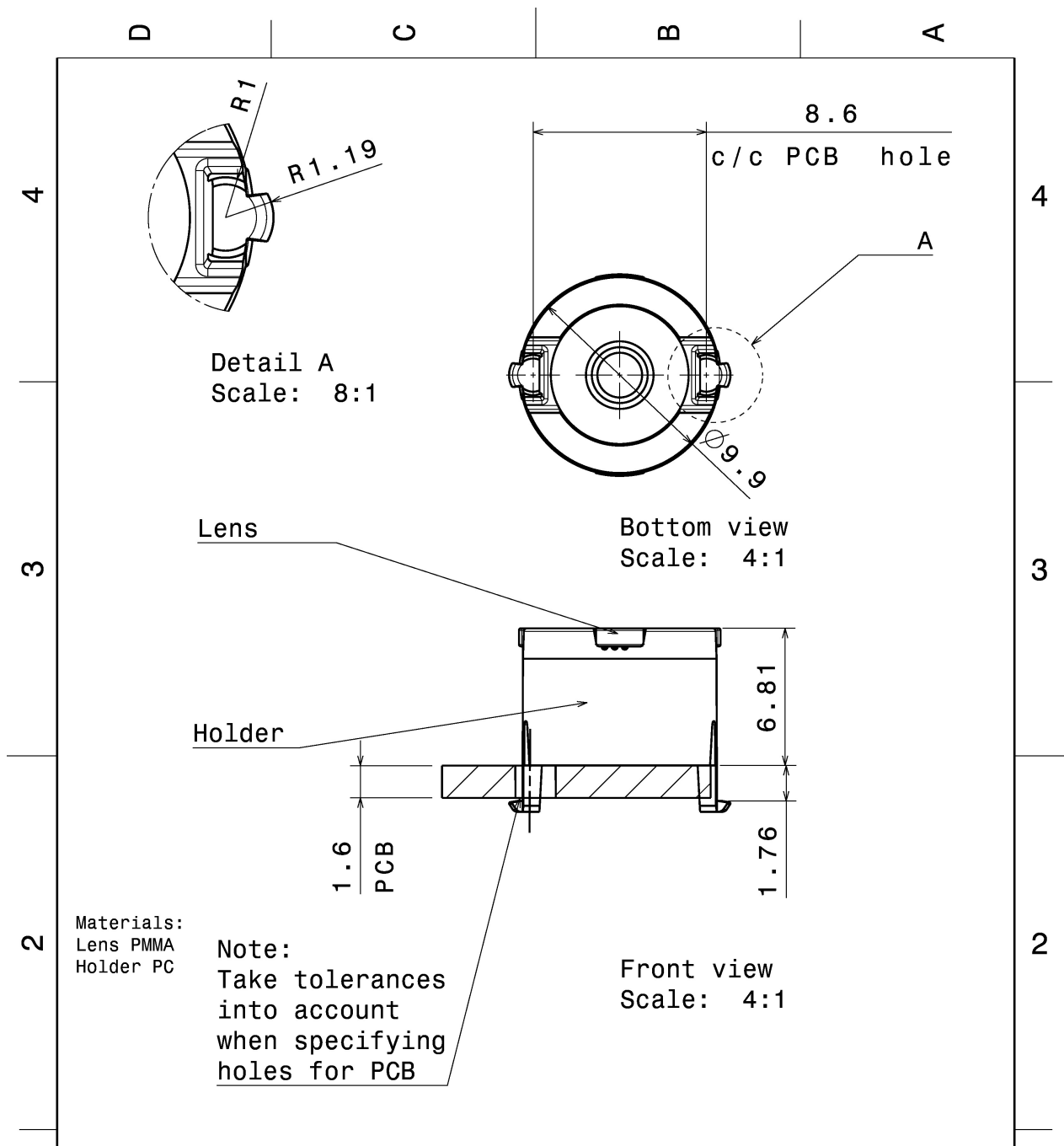

This drawing is our property. It can't be reproduced or communicated without our written agreement.		LEDiL		Ledil Oy Salorankatu 10 FIN-24240 SALO Finland	
DRAWING TITLE					
DRAWN BY pl		DATE 20.06.2012		Datasheet Lisa2-clip16-XT series Assy	
CHECKED BY sn	DATE 20.7.2011	SIZE A4	DRAWING NUMBER		REV 1
DESIGNED BY pl	DATE 20.06.2012	SCALE 4:1	WEIGHT (g)	SHEET 1/1	

PHOTOMETRIC DATA (MEASURED):



LED XP-G2
 FWHM 25.0°
 Efficiency 89 %
 Peak intensity 3.500 cd/lm
 Required components:

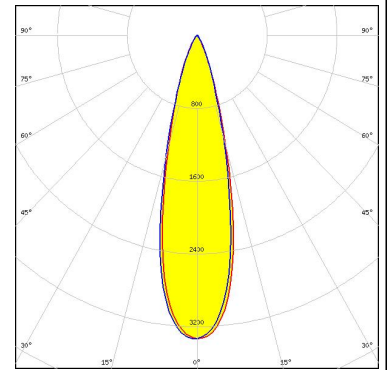

LED XP-G3
 FWHM 29.0°
 Efficiency 85 %
 Peak intensity 2.390 cd/lm
 Required components:

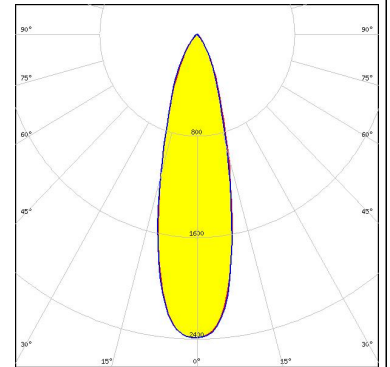
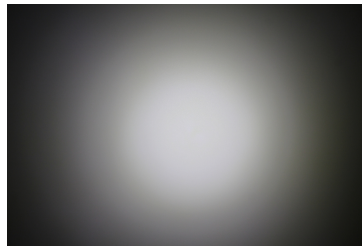

LED XT-E
 FWHM 26.0°
 Efficiency 89 %
 Peak intensity 3.260 cd/lm
 Required components:

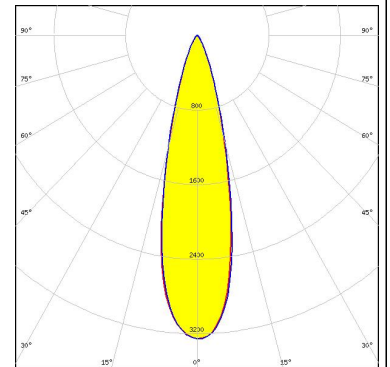

LED LUXEON T
 FWHM 28.0°
 Efficiency 87 %
 Peak intensity 2.700 cd/lm
 Required components:

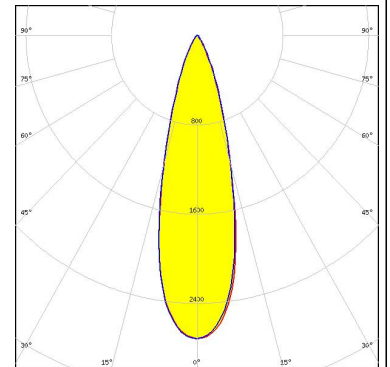
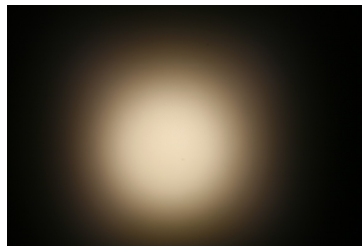

PHOTOMETRIC DATA (MEASURED):



LED LUXEON TX
 FWHM 26.0°
 Efficiency 88 %
 Peak intensity 3.380 cd/lm
 Required components:

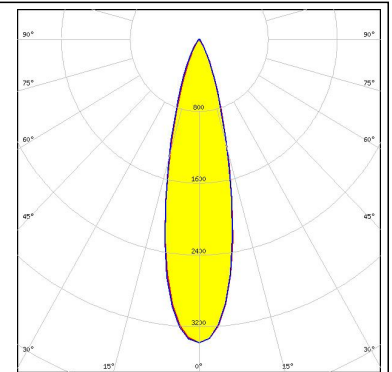
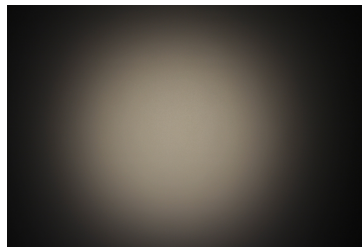

LED NCSxx19B
 FWHM 23.0°
 Efficiency 85 %
 Peak intensity 4.100 cd/lm
 Required components:

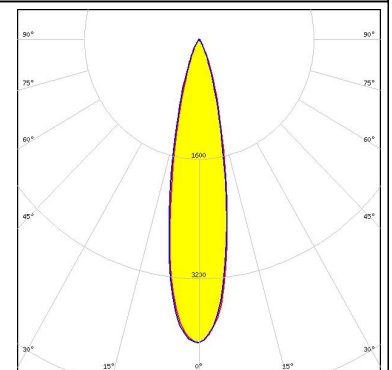

LED NVSxx19B/NVSxx19C
 FWHM 27.0°
 Efficiency 86 %
 Peak intensity 2.600 cd/lm
 Required components:

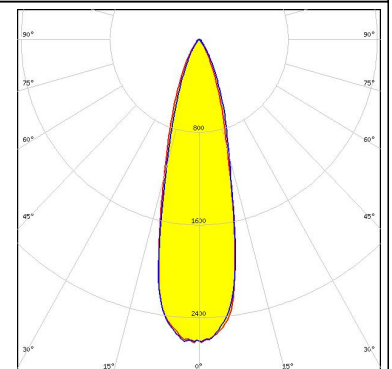
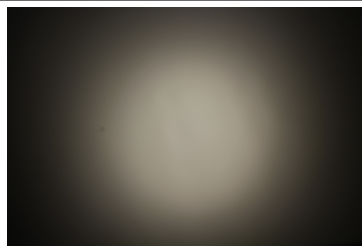

LED Oslon Square EC
 FWHM 26.0°
 Efficiency 85 %
 Peak intensity 3.400 cd/lm
 Required components:

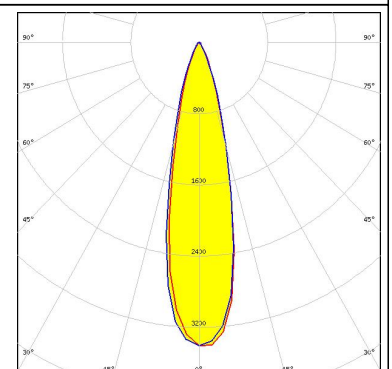
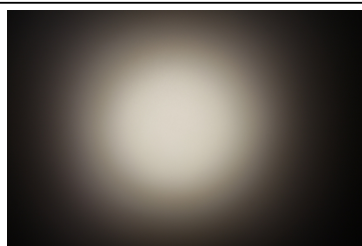

PHOTOMETRIC DATA (MEASURED):

OSRAM
Opto Semiconductors

LED SFH 4715S
FWHM 22.0°
Efficiency %
Peak intensity cd/lm
Required components:

OSRAM
Opto Semiconductors

LED SFH 4725S
FWHM 23.0°
Efficiency %
Peak intensity cd/lm
Required components:

SAMSUNG

LED LH351Z
FWHM 26.0°
Efficiency 87 %
Peak intensity 3.500 cd/lm
Required components:

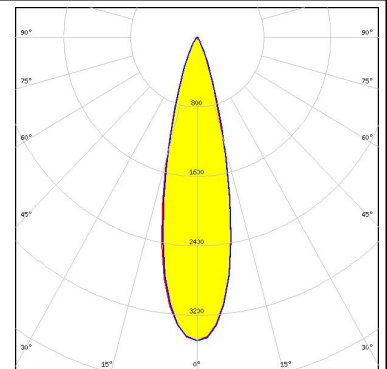
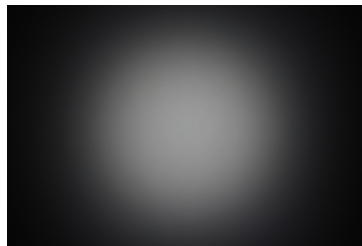

PHOTOMETRIC DATA (SIMULATED):

LUMILEDS

LED LUXEON H50-2
FWHM 24.0°
Efficiency 89 %
Peak intensity 3.100 cd/lm
Required components:

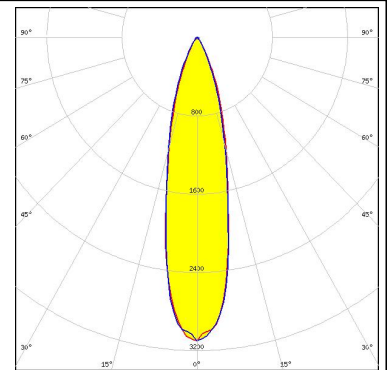

LUMILEDS

LED LUXEON IR Compact
FWHM 14.0°
Efficiency 82 %
Peak intensity 0.000 cd/lm
Required components:

LUMILEDS

LED LUXEON IR Domed 150
FWHM 20.0°
Efficiency 88 %
Peak intensity 0.000 cd/lm
Required components:

OSRAM Opto Semiconductors

LED Oslon Square Gen3
FWHM 21.0°
Efficiency 91 %
Peak intensity 4.440 cd/lm
Required components:

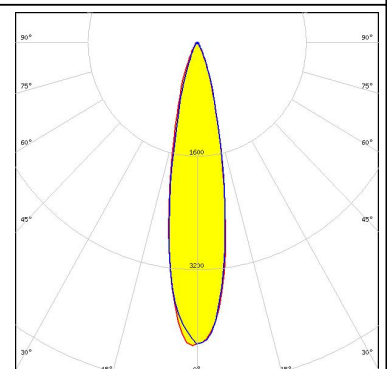

PHOTOMETRIC DATA (SIMULATED):

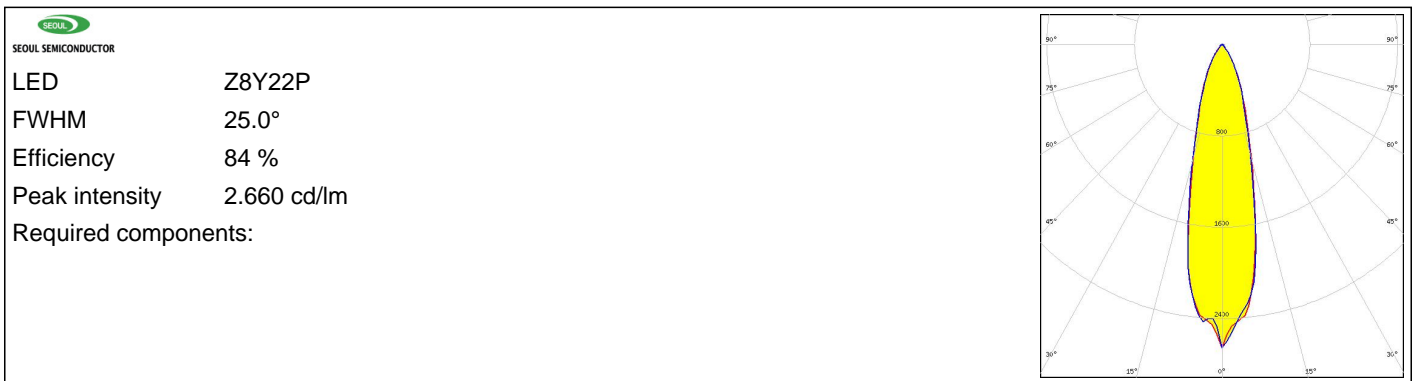

GENERAL INFORMATION:

NOTE: The typical beam angle will be changed by different color, chip size and chip position tolerance. The typical total beam angle is the full angle measured where the luminous intensity is half of the peak value.

MATERIALS:

As part of our continuous research and improvement processes, and to ensure the best possible quality and availability of our products, LEDiL reserves the right to change material grades without notice.

PRODUCT DATA USER AGREEMENT AND DISCLAIMER:

The measured data in the provided downloadable LEDiL Product Datasheets and Mechanical 2D-Drawings is rounded and provided as reference for planning. LEDiL Oy's optical specifications have been verified by conducting performance testing of the products in accordance with the company's quality system. The reported data are averaged results of multiple measurements with typical variation. LEDiL Oy reserves the right to without prior notification make changes and improvements to its products.

LEDiL Oy assumes neither warranty, nor guarantee nor any other liability of any kind for the contents and correctness of the provided data. The provided data has been generated with highest diligence but the provided data may in reality not represent the complete possible variation range of all intrinsic parameters. Therefore, in certain cases a deviation from the provided data could occur.

LEDiL Oy reserves the right to undertake technical changes of its products without further notification which could lead to changes in the provided data. LEDiL Oy assumes no liability of any kind for the possible deviation from any provided data or any other damage resulting from the usage of the provided data.

The user agrees to this disclaimer and user agreement with the download or usage of the provided files.

LEDiL Oy

Joensuunkatu 13
FI-24240 SALO
Finland

LEDiL Inc.

228 West Page Street
Suite D
Sycamore IL 60178
USA

Local sales and technical support

[www.ledil.com/
where_to_buy](http://www.ledil.com/where_to_buy)

Shipping locations

Salo, Finland
Hong Kong, China

Distribution Partners

[www.ledil.com/
where_to_buy](http://www.ledil.com/where_to_buy)