

# PQ25VB8M2FZ/ PQ25VB012FZ

## Variable Output Type, built-in Overheat Shut-Down Function Low Power-Loss Voltage Regulator

### ■ Features

1. Compact resin full mold package  
(Equivalent to TO-220)
2. Low power-loss  
(Dropout voltage: MAX. 0.5V at  $I_O=0.5A$ )
3. Overheat shut-down function (keep shut-down output until power-on again)
4. Variable output voltage (setting range:1.5 to 25V)
5. With built-in overcurrent protection
6. Reference voltage precision:±2.0%
7. With built-in ON/OFF control function

### ■ Applications

1. Series power supply for TVs and VCRs
2. Power supplies for equipment
3. CRT displays

### ■ Absolute Maximum Ratings (Ta=25°C)

Parameter	Symbol	Rating	Unit
*1 Input voltage	$V_{IN}$	27	V
*1 ON/OFF control voltage	$V_C$	27	V
*1 Output adjustment terminal voltage	$V_{ADJ}$	7	V
Output current	$I_O$	0.8	A
		1	
*2 Power dissipation	$P_{D1}$	1.25	W
	$P_{D2}$	12.5	W
*3 Junction temperature	$T_j$	150	°C
Operating temperature	$T_{opr}$	-20 to +80	°C
Storage temperature	$T_{stg}$	-40 to +150	°C
Soldering temperature	$T_{sol}$	260 (10s)	°C

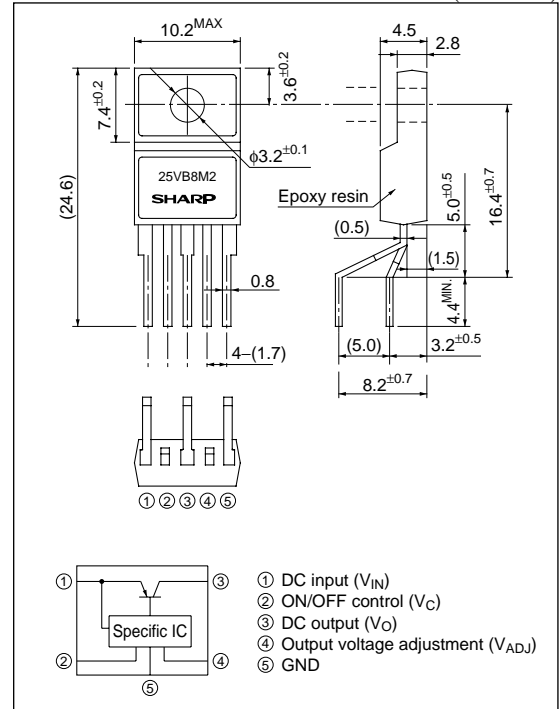
\*1 All are open except GND and applicable terminals

\*2  $P_{D1}$ :No heat sink,  $P_{D2}$ :With infinite heat sink

\*3 Overheat shut-down function operates at  $T_j \geq 110^\circ C$

### ■ Outline Dimensions

(Unit : mm)



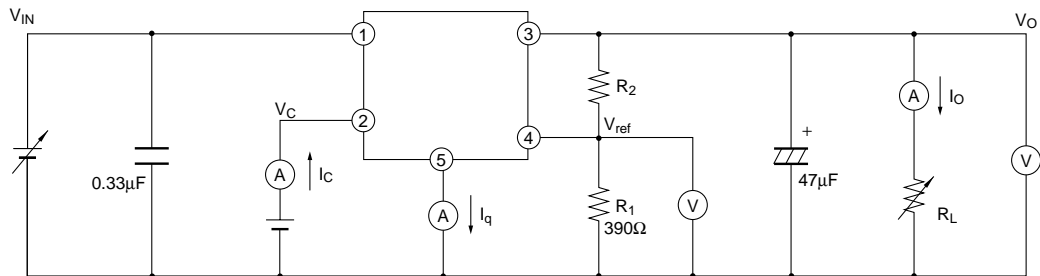
**■ Electrical Characteristics** (Unless otherwise specified, condition shall be  $V_{IN}=12V$ ,  $V_O=10V$  ( $R_1=390\Omega$ ),  $I_o=0.5A$ ,  $V_O=2.7V$ ,  $T_a=25^\circ C$ )

Parameter	Symbol	Conditions	MIN.	TYP.	MAX.	Unit		
Minimum operating supply voltage	$V_{IN(MIN)}$	—	4.5	—	27	V		
Output voltage range	$V_O$	—	1.5	—	25	V		
Load regulation	<b>PQ25VB8M2FZ</b> <b>PQ25VB012FZ</b>	$R_{regL}$	$I_o=5mA$ to 0.8A		—	0.3	1.0	%
			$I_o=5mA$ to 1A					
Line regulation	$R_{regI}$	$V_{IN}=11$ to 20V, $I_o=5mA$	—	0.5	1.0	%		
Ripple rejection	RR	Refer to Fig.2	45	55	—	dB		
Reference voltage	$V_{ref}$	—	1.225	1.25	1.275	V		
Reference voltage temperature coefficient	$TcV_O$	$T_j=0$ to 110°C, $I_o=5mA$	—	$\pm 1.0$	—	%		
Dropout voltage	$V_{I-O}$	<sup>*4</sup> $I_o=0.5A$	—	—	0.5	V		
<sup>*5</sup> Output on control voltage	$V_{C(ON)}$	<sup>*5</sup>	2.0	—	—	V		
Output on control current	$I_{C(ON)}$	$V_C=2.7V$	—	—	20	$\mu A$		
Output off control voltage	$V_{C(OFF)}$	—	—	—	0.8	V		
Output off control current	$I_{C(OFF)}$	$V_C=0.4V$	—	—	-0.4	mA		
Quiescent current	$I_q$	$I_o=0A$	—	—	7	mA		
Overheating shutdown temperature	$T_{SD}$	—	110	130	150	$^\circ C$		

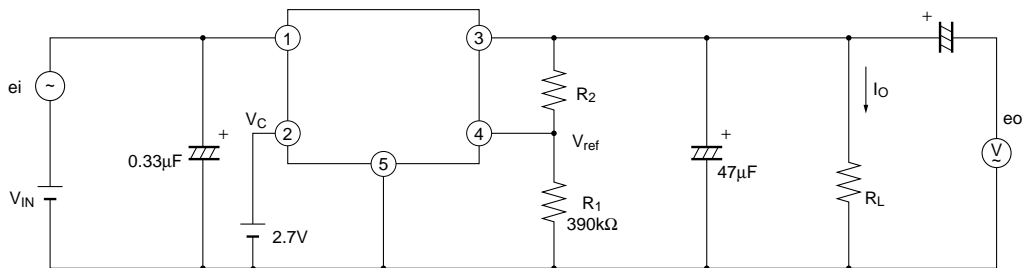
<sup>\*4</sup> Input voltage shall be the value when output voltage is 95% in comparison with the initial value

<sup>\*5</sup> In case of opening ON/OFF control terminal ②, output voltage turns on

**Fig.1 Standard Test Circuit**

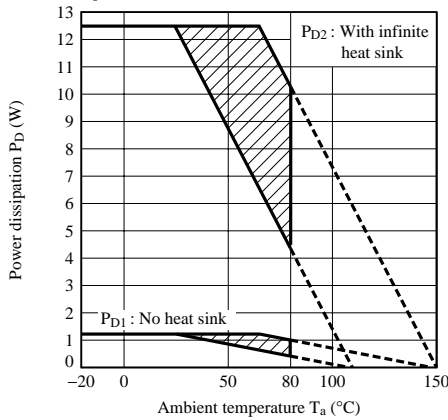


**Fig.2 Test Circuit for Ripple Rejection**



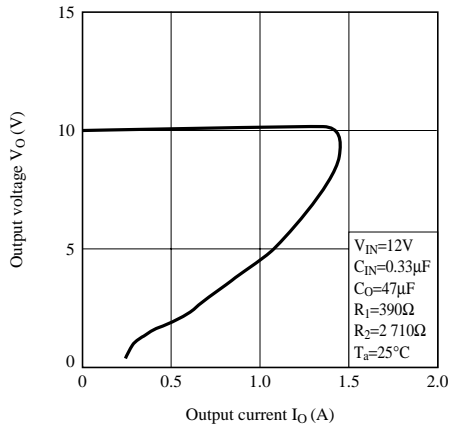
$f=120Hz$ (sine wave)  
 $e_i(rms)=0.5V$   
 $V_O=10V$ ( $R_1=390\Omega$ )  
 $V_{IN}=12V$   
 $I_o=0.5A$   
 $RR=20\log(e_i(rms)/e_o(rms))$

**Fig.3 Power Dissipation vs. Ambient Temperature**

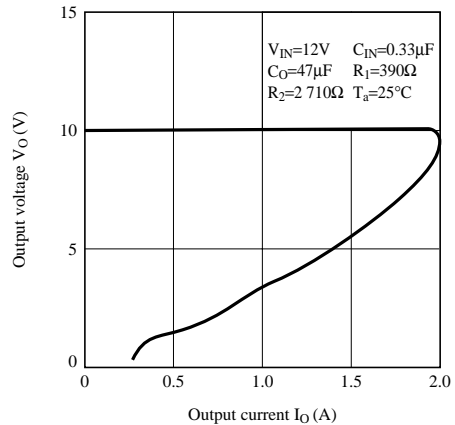


Note) Oblique line portion: Overheat protection may operate in this area

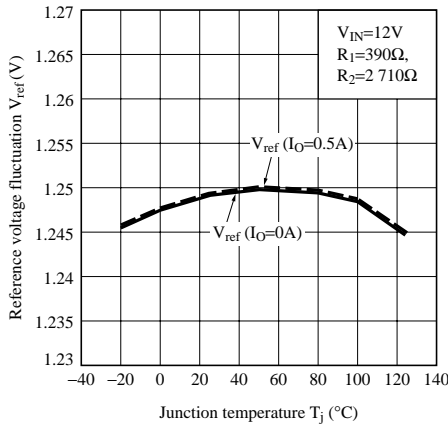
**Fig.4 Overcurrent Protection Characteristics (PQ25VB8M2FZ)**



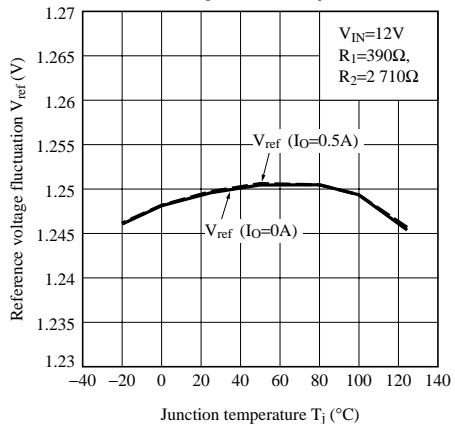
**Fig.5 Overcurrent Protection Characteristics (PQ25VB012FZ)**



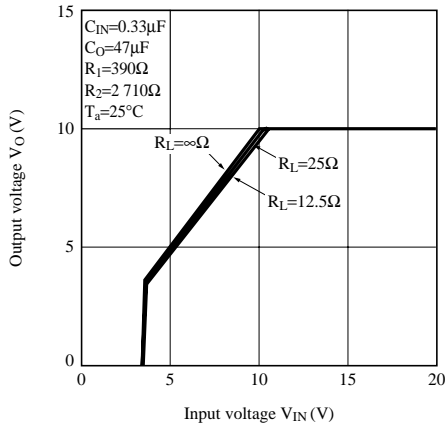
**Fig.6 Reference Voltage Fluctuation vs. Junction Temperature (PQ25VB8M2FZ)**



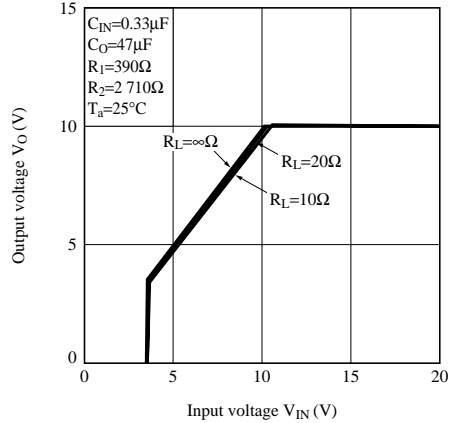
**Fig.7 Reference Voltage Fluctuation vs. Junction Temperature (PQ25VB012FZ)**



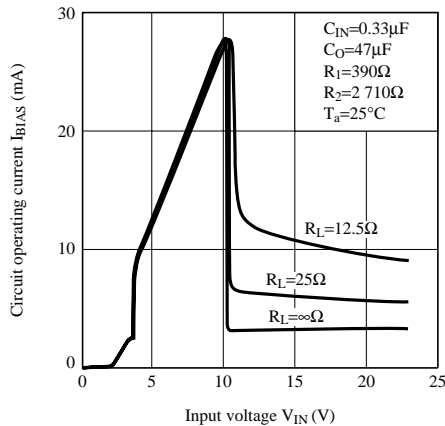
**Fig.8 Output Voltage vs. Input Voltage (PQ25VB8M2FZ)**



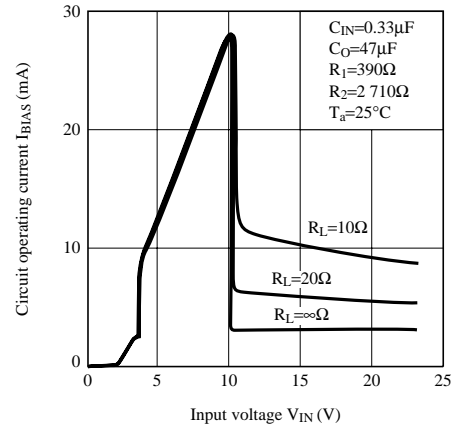
**Fig.9 Output Voltage vs. Input Voltage (PQ25VB012FZ)**



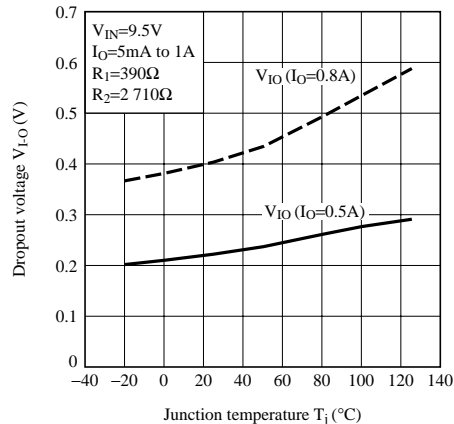
**Fig.10 Circuit Operating Current vs. Input Voltage (PQ25VB8M2FZ)**



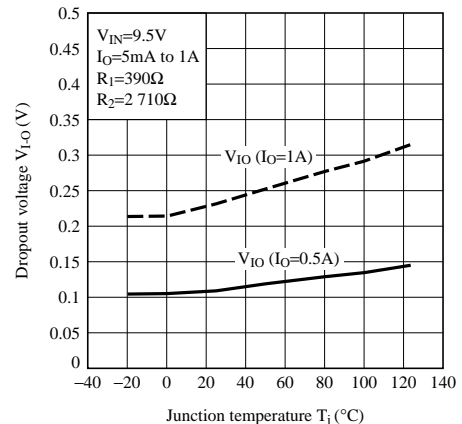
**Fig.11 Circuit Operating Current vs. Input Voltage (PQ25VB012FZ)**



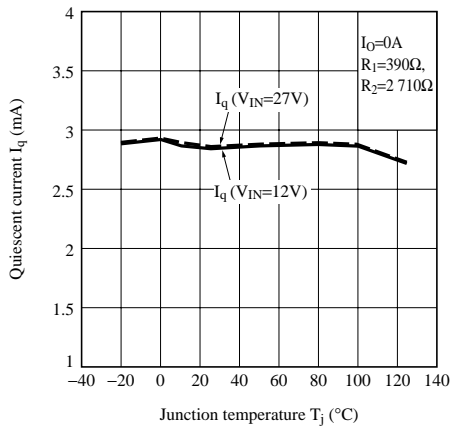
**Fig.12 Dropout voltage vs. Junction Temperature (PQ25VB8M2FZ)**



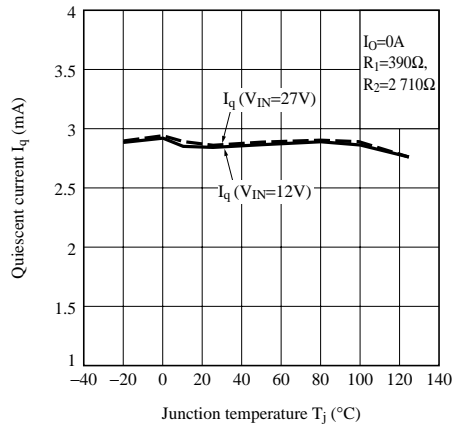
**Fig.13 Dropout voltage vs. Junction Temperature (PQ25VB012FZ)**



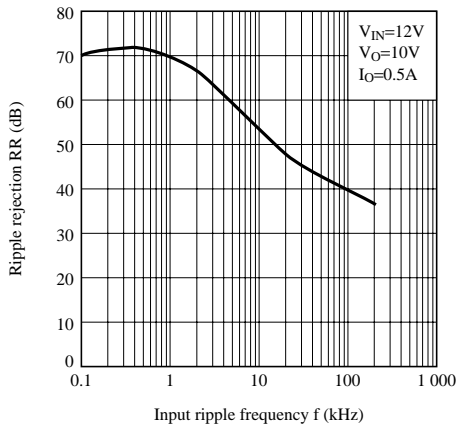
**Fig.14 Quiescent Current vs. Junction Temperature (PQ25VB8M2FZ)**



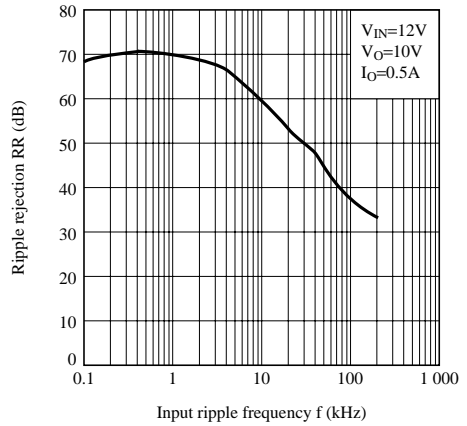
**Fig.15 Quiescent Current vs. Junction Temperature (PQ25VB012FZ)**



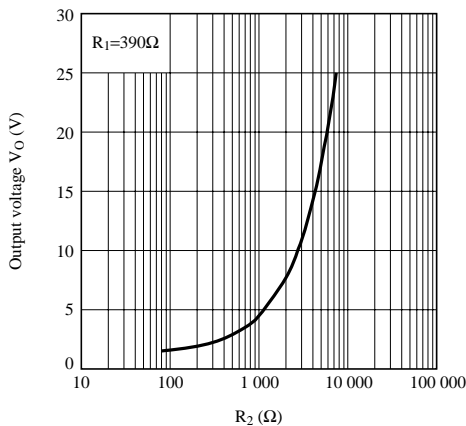
**Fig.16 Ripple Rejection vs. Input Ripple Frequency (PQ25VB8M2FZ)**



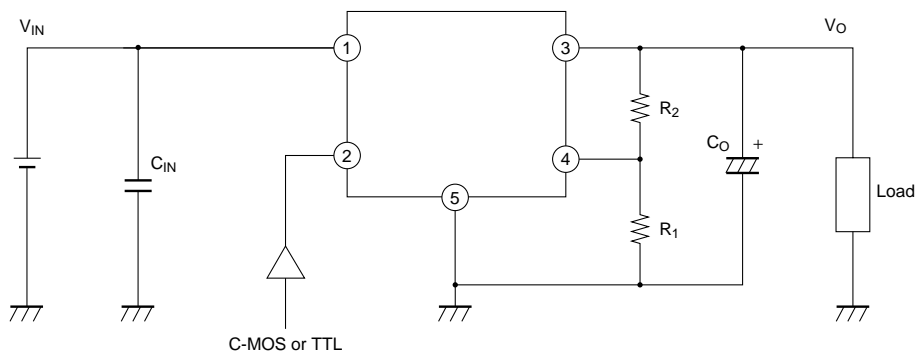
**Fig.17 Ripple Rejection vs. Input Ripple Frequency (PQ25VB012FZ)**



**Fig.18 Output Voltage Adjustment Characteristics**



## ■ Precautions for Use



### 1. External connection

- (1) The connecting wiring of  $C_O$  and each terminal must be as short as possible. Owing to type, value and wiring condition of capacitor, it may oscillate. Confirm the output waveform under the actual condition before using.
- (2) ON/OFF control terminal ② is compatible with LS-TTL. It enables to be directly drive by TTL or C-MOS standard logic (RCA4000 series).
- (3) If voltage is applied under the conditions that the device pin is connected divergently or reversely, the deterioration of characteristics or damage may occur. Never allow improper mounting.
- (4) If voltage exceeding the voltage of DC input terminal ① is applied to the output terminal ③, the element may be damaged. Especially when the DC input terminal ① is short-circuited to the GND in ordinary operating state, charges accumulated in the output capacitor  $C_O$  flow to the input side, causing damage to the element. In this case, connect the ordinary silicon diode as shown in the figure.

### 2. Thermal protection design

Power dissipation of devices is obtained by the following equation.

$$P_D = I_O \times (V_{IN} - V_O) + V_{IN} \times I_q$$

When ambient temperature  $T_a$  and power dissipation  $P_D$  during operation are determined, operate element within the safety operation area specified by the derating curve. Insufficient radiation gives an unfavorable influence to the normal operation and reliability of the device.

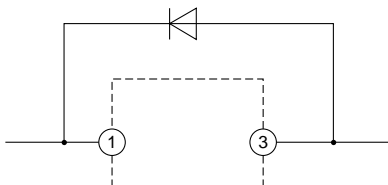
In the external area of the safety operation area shown by the derating curve, the overheat protection circuit may operate to shut-down output. However please avoid keeping such condition for a long time.

### 3. ESD (Electrostatic Sensitivity Discharge)

Be careful not to apply electrostatic discharge to the device since this device employs a bipolar IC and may be damaged by electrostatic discharge. Followings are some methods against excessive voltage caused by electro static discharge.

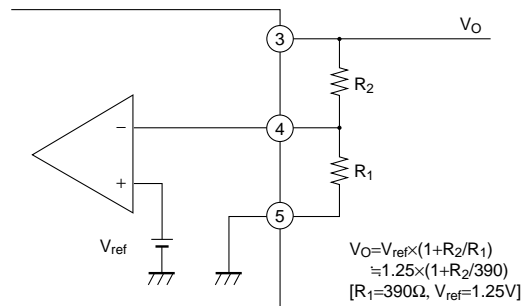
- (1) Human body must be grounded to discharge the electro charge which is charged in the body or cloth.
- (2) Anything that is in contact with the device such as workbench, inserter, or measuring instrument must be grounded.
- (3) Use a soldering dip basin with a minimum leak current (isolation resistance  $10M\Omega$  or more) from the AC power supply line.

Also the soldering dip basin must be grounded.

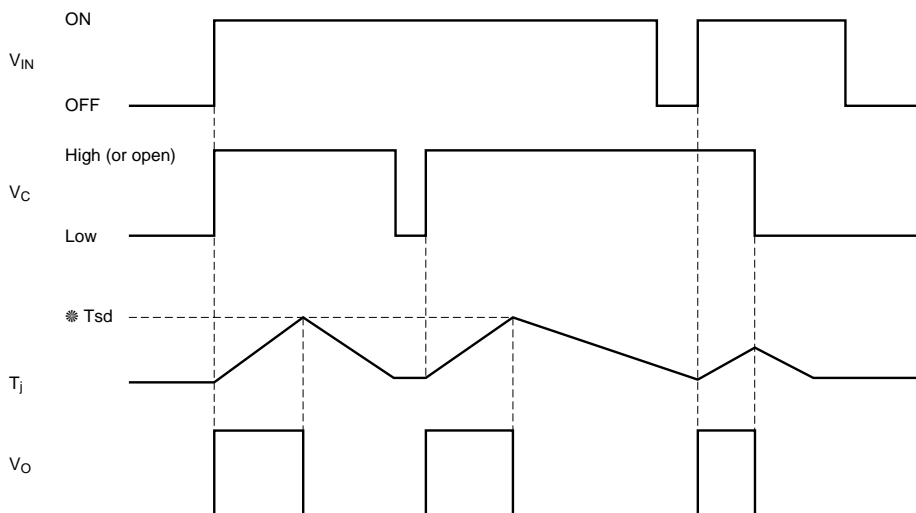


## Output Voltage Fine Tuning

1. Connecting external resistors  $R_1$  and  $R_2$  to terminals ③, ④, ⑤ allows the output voltage to be fine tuned from 1.5V to 25V. Refer to the figure below and Fig.18 when connecting external resistors for fine tuning output voltage.



## Overheat Shut-down Characteristics



\*  $T_{sd}$ : Overheat shut-down temperature ( $T_j \geq 110^\circ C$ )

- (1) Overheat shut-down operates at  $T_j = T_{sd}$  and output OFF-state is maintained.
- (2) OFF-state is kept until  $V_{IN}$  is once turned off or  $V_C$  is turned down to the "L" level.

### NOTICE

- The circuit application examples in this publication are provided to explain representative applications of SHARP devices and are not intended to guarantee any circuit design or license any intellectual property rights. SHARP takes no responsibility for any problems related to any intellectual property right of a third party resulting from the use of SHARP's devices.
- Contact SHARP in order to obtain the latest device specification sheets before using any SHARP device. SHARP reserves the right to make changes in the specifications, characteristics, data, materials, structure, and other contents described herein at any time without notice in order to improve design or reliability. Manufacturing locations are also subject to change without notice.
- Observe the following points when using any devices in this publication. SHARP takes no responsibility for damage caused by improper use of the devices which does not meet the conditions and absolute maximum ratings to be used specified in the relevant specification sheet nor meet the following conditions:
  - (i) The devices in this publication are designed for use in general electronic equipment designs such as:
    - Personal computers
    - Office automation equipment
    - Telecommunication equipment [terminal]
    - Test and measurement equipment
    - Industrial control
    - Audio visual equipment
    - Consumer electronics
  - (ii) Measures such as fail-safe function and redundant design should be taken to ensure reliability and safety when SHARP devices are used for or in connection with equipment that requires higher reliability such as:
    - Transportation control and safety equipment (i.e., aircraft, trains, automobiles, etc.)
    - Traffic signals
    - Gas leakage sensor breakers
    - Alarm equipment
    - Various safety devices, etc.
  - (iii) SHARP devices shall not be used for or in connection with equipment that requires an extremely high level of reliability and safety such as:
    - Space applications
    - Telecommunication equipment [trunk lines]
    - Nuclear power control equipment
    - Medical and other life support equipment (e.g., scuba).
- Contact a SHARP representative in advance when intending to use SHARP devices for any "specific" applications other than those recommended by SHARP or when it is unclear which category mentioned above controls the intended use.
- If the SHARP devices listed in this publication fall within the scope of strategic products described in the Foreign Exchange and Foreign Trade Control Law of Japan, it is necessary to obtain approval to export such SHARP devices.
- This publication is the proprietary product of SHARP and is copyrighted, with all rights reserved. Under the copyright laws, no part of this publication may be reproduced or transmitted in any form or by any means, electronic or mechanical, for any purpose, in whole or in part, without the express written permission of SHARP. Express written permission is also required before any use of this publication may be made by a third party.
- Contact and consult with a SHARP representative if there are any questions about the contents of this publication.