

1 2 3 4 5 6

A

B

C

D

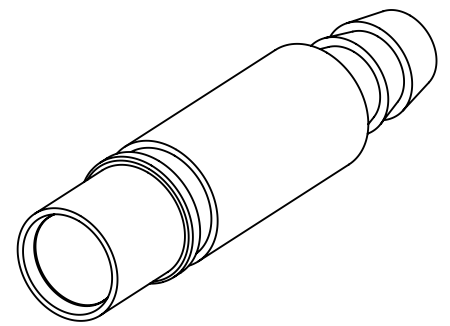
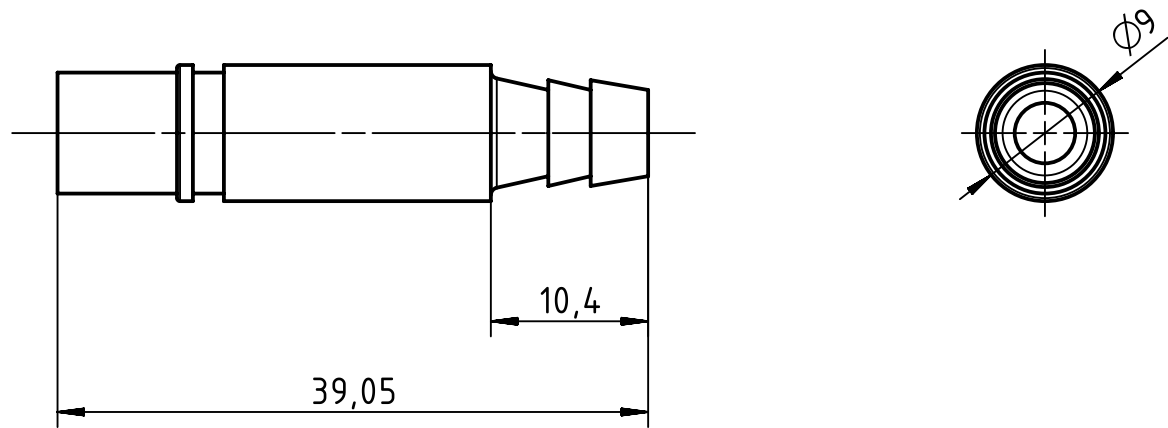

	All rights reserved Department EL PD - DE	Created by MOELLERLI	Inspected by BEISCHER	Standardisation SCHMIDTM	Date 2016-11-23	State Final Release	
	HARTING Electric GmbH & Co. KG D-32339 Espelkamp	Title Pneum. contact metal ID6mm female				Doc-Key / ECM-Nr. 100655197/UGD/001/D 500000111819	
		Type TB	Number 09 14 000 6406			Rev. D	Page 1/1