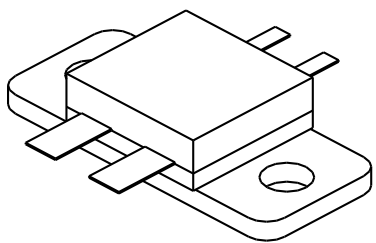

UTV200

20 Watts, 26.5 Volts, Class A
UHF Television - Band IV & V

<p>GENERAL DESCRIPTION</p> <p>The UTV 200 is a COMMON EMITTER transistor capable of providing 20 Watt Peak, Class A, RF Output Power over the band 470 - 860 MHz. The transistor includes double input prematching for full broadband capability. Gold Metalization and Diffused Ballasting are used to provide high reliability and supreme ruggedness.</p>	<p>CASE OUTLINE 55JV, STYLE 2</p> 
<p>ABSOLUTE MAXIMUM RATINGS</p> <p>Maximum Power Dissipation @ 25°C 80 Watts</p> <p>Maximum Voltage and Current</p> <p>BVces Collector to Emitter Voltage 50 Volts BVceo Collector to Emitter Voltage 28 Volts BVebo Emitter to Base Voltage 4.0 Volts Ic Collector Current 4.5 Amps</p> <p>Maximum Temperatures</p> <p>Storage Temperature - 65 to + 200°C Operating Junction Temperature + 200°C</p>	

ELECTRICAL CHARACTERISTICS @ 25 °C

SYMBOL	CHARACTERISTICS	TEST CONDITIONS	MIN	TYP	MAX	UNITS
Pout	Power Out - Pk Sync	F = 470 - 860 MHz	20			Watts
Pin	Power Input	Vcc = 26.5 Volts			2.8	Watts
Pg	Power Gain	Ic = 2.7 Amps	8.5	9.5		dB
IMD¹	Intermodulation Distortion	Pref = 20Watts		-48	-46	dB
VSWR₁	Load Mismatch Tolerance	F = 860 MHz			3:1	

LVceo²	Collector to Emitter Breakdown	Ic = 40 mA	28			Volts
BVces²	Collector to Base Breakdown	Ic = 20mA	50			Volts
BVebo²	Emitter to Base Breakdown	Ie = 10 mA	4			Volts
h_{FE}²	Current Gain	Vce = 5 V, 1 A	10		150	
Cob²	Output Capacitance	Vcb = 26 V, F = 1 MHz			36	pF
θjc	Thermal Resistance	Tc = 25°C			1.2	°C/W

Note 1: F1=860 MHz, F2=863.5 MHz, F3=864.5 Mhz

European test method, Vision = - 8dB, Sideband= - 16dB, Sound = -7 dB

Note 2: Per side

Initial Issue June, 1994

GHz TECHNOLOGY INC. RESERVES THE RIGHT TO MAKE CHANGES WITHOUT FURTHER NOTICE. GHz RECOMMENDS THAT BEFORE THE PRODUCT(S) DESCRIBED HEREIN ARE WRITTEN INTO SPECIFICATIONS, OR USED IN CRITICAL APPLICATIONS, THAT THE PERFORMANCE CHARACTERISTICS BE VERIFIED BY CONTACTING THE FACTORY.

DC SAFE OPERATING AREA

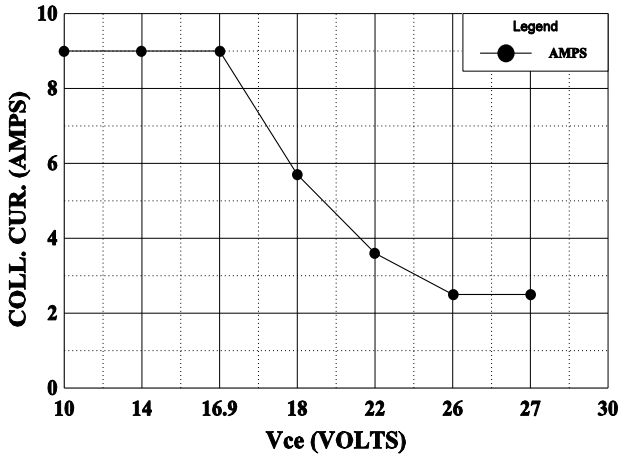

POWER OUTPUT vs POWER INPUT

Vcc = 26.5V, Frequency 860MHz

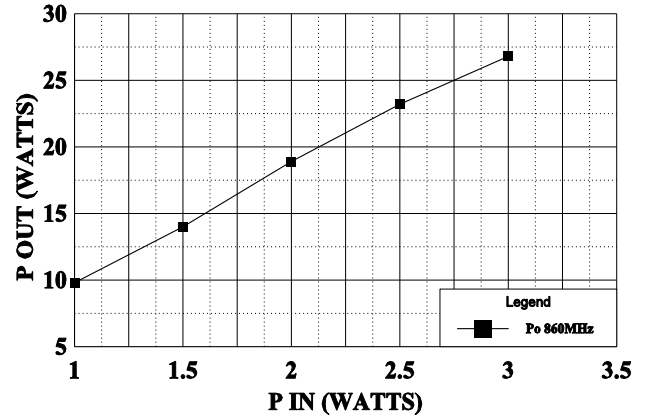

IMD vs Icq

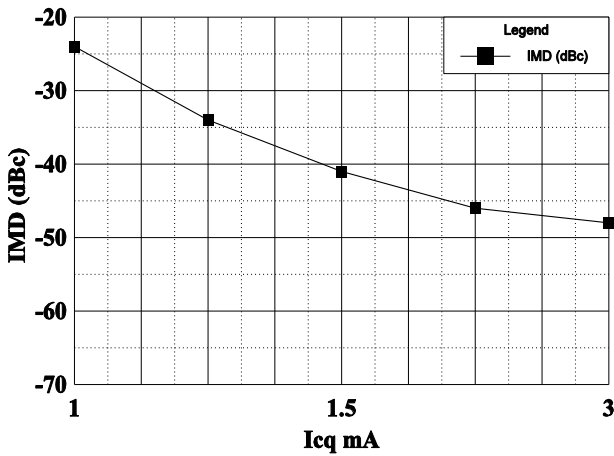

IMD vs P out

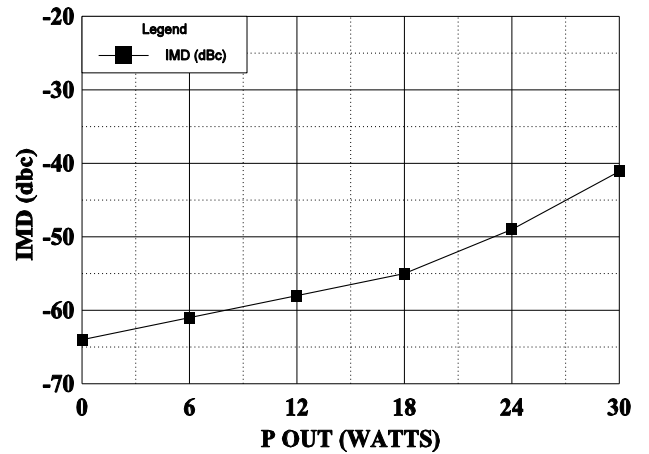

INPUT IMPEDANCE vs FREQUENCY

Vcc = 26.5V, Pin =

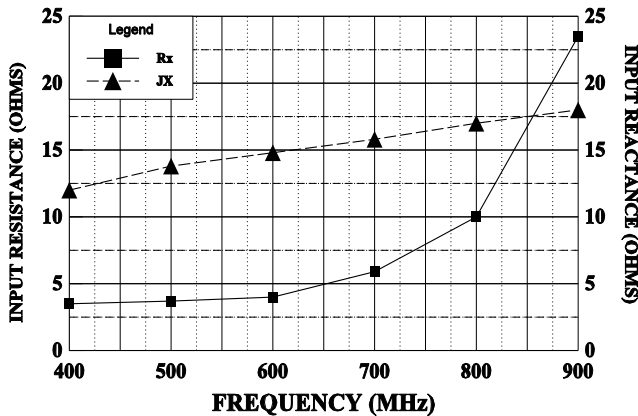

LOAD IMPEDANCE vs FREQUENCY

Vcc = 26.5V

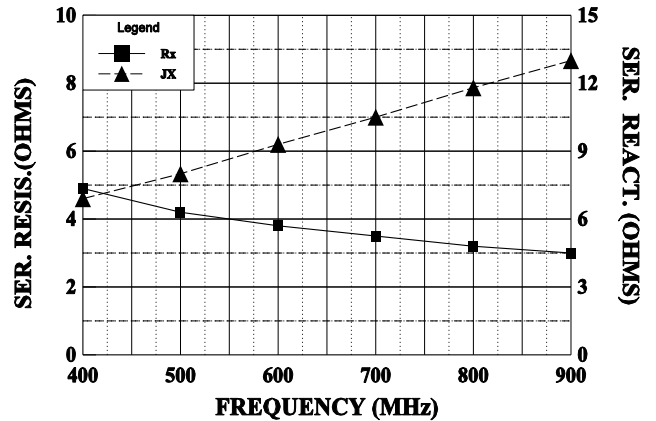

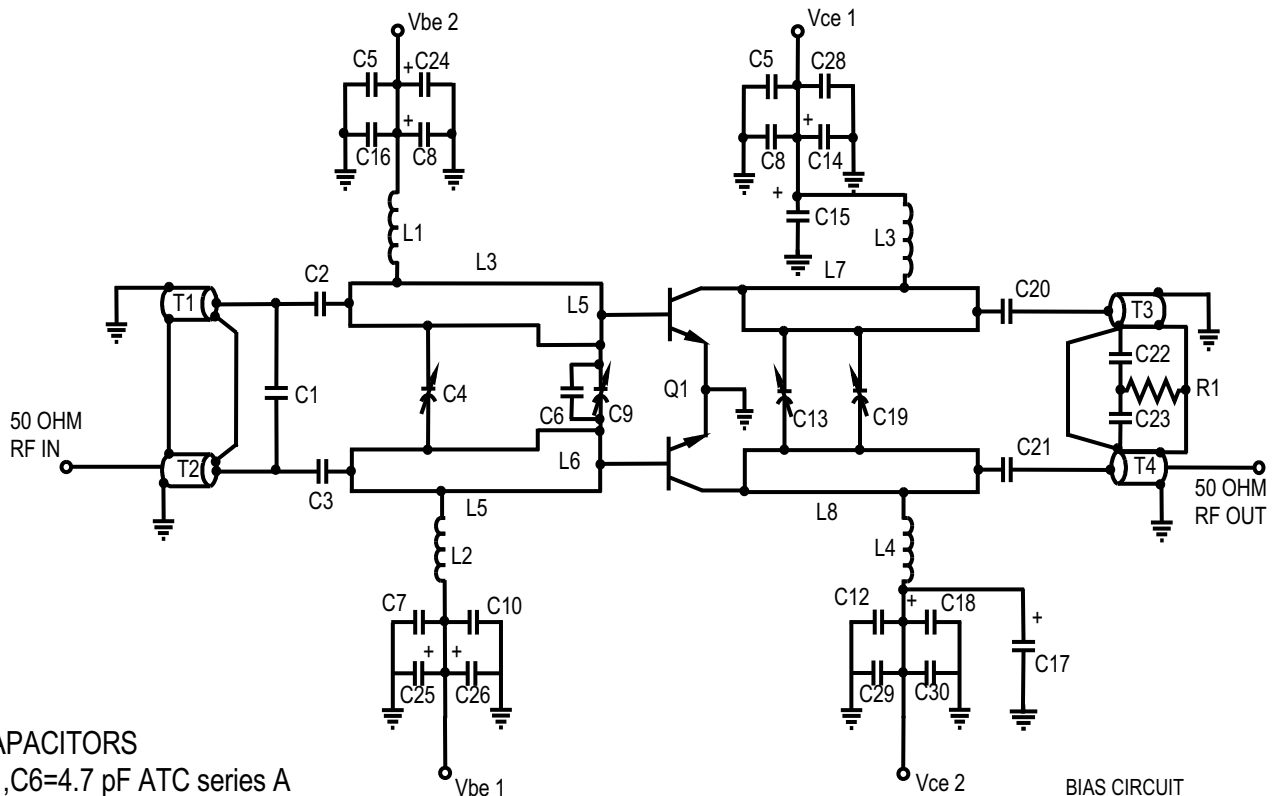

CAPACITORS

- C1,C6=4.7 pF ATC series A
- C2,C3,C20,C21=33 pF ATC series A
- C4,C9=1.2-3.5 pF film diel. trimmer
- C5,C7,C11,C12=0.01 mF, 50V Tantalum
- C8,C15,C17,C25=1 mF, 50 V Tantalum
- C10,C16,C27,C12=0.1 mF 50 V disc ceramic
- C13=0.6-6 pF piston trimmer
- C19=0.35-3.5 pF piston trimmer
- C18,C24,C14,C26=10 mF, 50 V
- C28,C30=0.001 mF, 50 V disc ceramic
- C31=100 mF, 50 V electrolytic

INDUCTORS

- L1,L2=0.46 microHenry molded
- L3,L4=1 turn #18 magnet wire on a 0.325" form

TRANSISTORS

- Q1=GHz UTV-200
- Q2,Q3=MJE172

MICROSTRIPLINES

- L3,L4=0.075" X 0.65"
- L5,L6=0.120" X 0.31"
- L7,L8=0.120" X 1.33"

RESISTORS

- R1=10 Ohm, 1/2 W Carbon
- R2,R6=500 Ohm potentiometer
- R3,R7=4.7K Ohm, 3W, 1% Carbon
- R4,R8=1 Ohm, 3W, 1% Carbon film
- R5,R9=47 Ohm, 1/4W Carbon film

TRANSFORMERS

- T1,T2,T3,T4=50 Ohm semi-rigid coax cable (0.056" X 1.1") soldered to 0.035" X 1.1" microstrip

DIODES

- CR1,CR2=IN4148