

This document is the property of Amphenol Corporation and is delivered on the express condition that it is not to be disclosed, reproduced or used, in whole or in part, for manufacture or sale by anyone other than Amphenol Corporation without its prior consent, and that no right is granted to disclose or to use any information in this document.

CUSTOMER DRAWING ORIGINAL

REVISIONS				
SYM	ECN No.	DESCRIPTION	DATE	APPROVED
A		RELEASE FOR RoHS	07/07/2005	Henry Ko

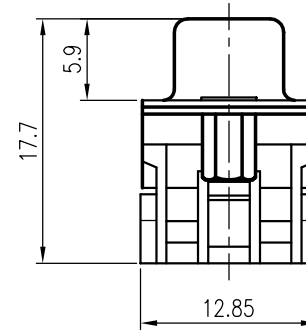
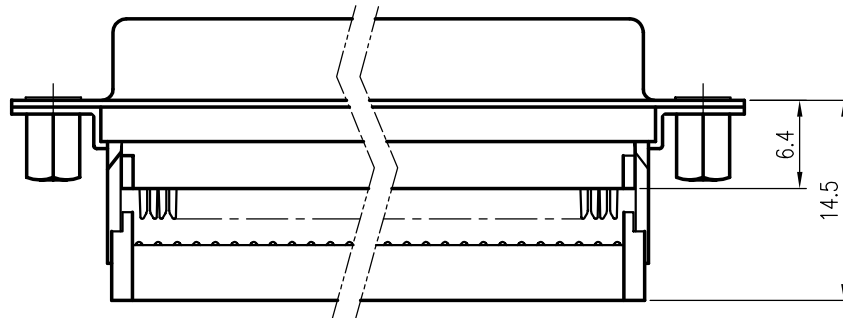
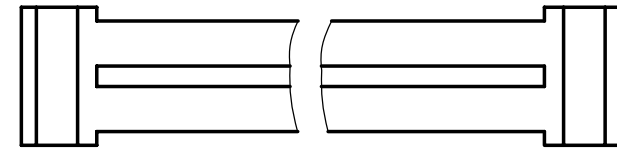
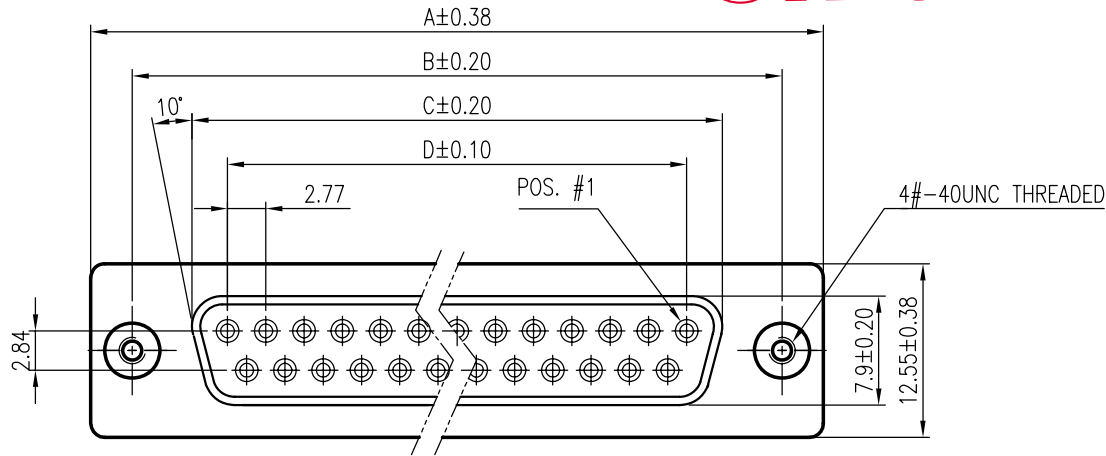

STRAIN RELIEF



AFTER ASSEMBLY

NOTES:

- FRONT SHELL FINISH: NICKEL PLATED
- CONTACT: PHOSPHOR BRONZE, SELECTIVE GOLD PLATED
- INSULATOR: PBT, UL 94V-0, COLOR- BLACK
- THIS PRODUCT DOESN'T CONTAIN ENVIRONMENTAL HAZARDOUS MATERIALS PER DIRECTIVE 2002/95/EC FOR RoHS.

					TOLERANCE m/m	APPROVALS	DATE	TITLE	Amphenol®		
37	69.32	63.50	54.76	49.86	x. ±0.30	DRAWN Sondra Sang	07/07/05	G17K SERIES FLAT RIBBON CABLE IDC D-SUB, RECEPTACLE MATEL SHELL	Amphenol Corporation Amphenol Taiwan Corporation		
25	53.04	47.04	38.38	x.x ±0.25	CHECKED Laura Su						
15	39.24	33.32	24.56	19.39	x.xx ±0.15	APPROVED Ken Lin for	07/07/05		SCALE N.A.	SHEET 1 OF 1	REV. A
9	30.84	24.99	16.24	11.08	x.xxx ±0.08			DRAWING NO.			
NO. OF POSITION	A	B	C	D	ANGULAR ±2°	UNIT MM	SIZE A4	G17K XXOX 2011 EU	DSUB-G17KXXOX2011EU-25		
					UNLESS OTHERWISE SPECIFIED						

This document is the property of Amphenol Corporation and is delivered on the express condition that it is not to be disclosed, reproduced or used, in whole or in part, for manufacture or sale by anyone other than Amphenol Corporation without its prior consent, and that no right is granted to disclose or to use any information in this document.

CUSTOMER DRAWING ORIGINAL

REVISIONS				
SYM	ECN No.	DESCRIPTION	DATE	APPROVED
A		RELEASE FOR RoHS	10/07/2005	Henry Ko

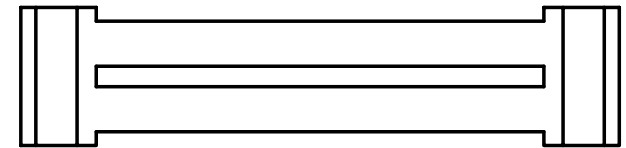
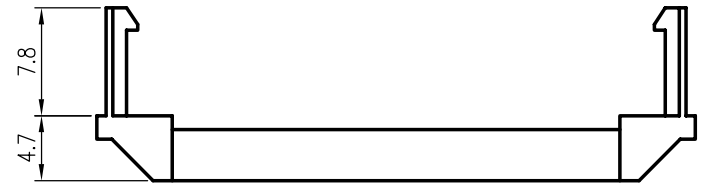
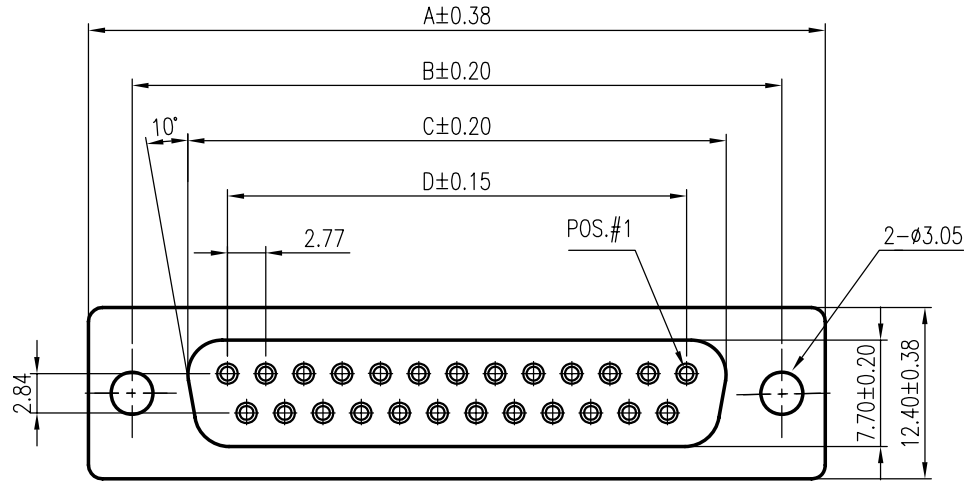

STRAIN RELIEF

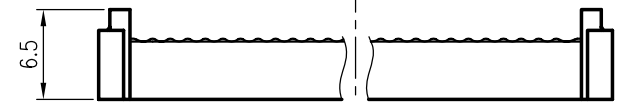
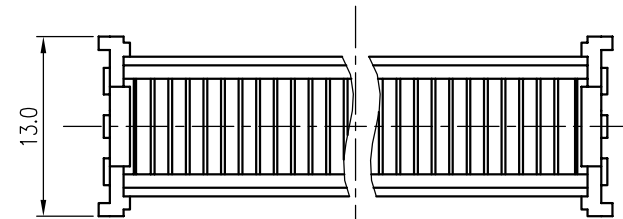
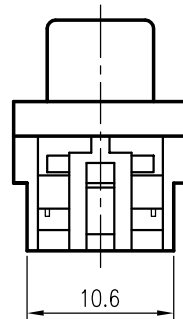
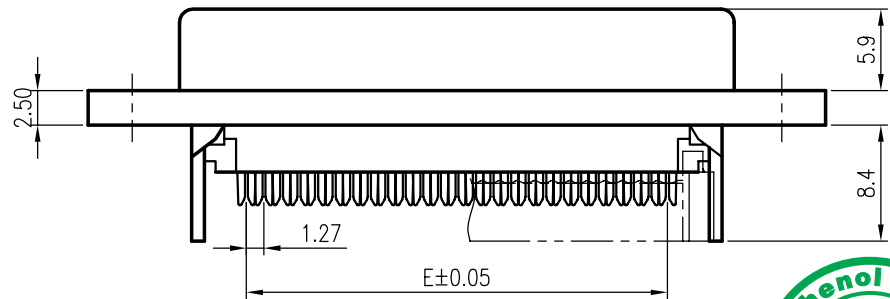

IDC COVER

NOTES:

- CONTACTS FINISH: SELECTIVE GOLD PLATED
- INSULATOR: PBT GLASS FIBER FILLED UL 94V-0, COLOR- BLACK
- THIS PRODUCT DOESN'T CONTAIN ENVIRONMENTAL HAZARDOUS MATERIALS PER DIRECTIVE 2002/95/EC FOR RoHS.



PART NUMBERS	NO. OF CONTACTS	DIM. A	DIM. B	DIM. C	DIM. D	DIM. E	TOLERANCE m/m	APPROVALS	DATE	TITLE	Amphenol® Amphenol Corporation Amphenol Taiwan Corporation
							x. ±0.30 x.x ±0.25 x.xx ±0.15 x.xxx ±0.08 ANGULAR ±2° UNLESS OTHERWISE SPECIFIED	DRAWN Sondra Sang CHECKED Laura Su APPROVED Ken Lin for	10/07/05 10/07/05 10/07/05		
G17K 090X 3101 EU	9	30.50	24.99	16.00	11.08	10.16				G17K SERIES FLAT RIBBON CABLE IDC D-SUB, RECEPT. ALL PLASTIC	SCALE N.A. SHEET 1 OF 1 DRAWING NO. DSUB-G17KXXOX3101EU-25 REV. A
G17K 150X 3101 EU	15	39.00	33.32	24.27	19.39	17.78					
G17K 250X 3101 EU	25	53.08	47.04	38.22	33.24	30.48					
G17K 370X 3101 EU	37	69.25	63.50	54.65	49.86	45.72					
							UNLESS OTHERWISE SPECIFIED		UNIT MM		

This document is the property of Amphenol Corporation and is delivered on the express condition that it is not to be disclosed, reproduced or used, in whole or in part, for manufacture or sale by anyone other than Amphenol Corporation without its prior consent, and that no right is granted to disclose or to use any information in this document.

CUSTOMER DRAWING

ORIGINAL

REVISIONS				
SYM	ECN No.	DESCRIPTION	DATE	APPROVED
A		RELEASE FOR RoHS	12/15/2005	Henry Ko

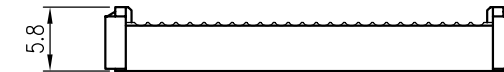
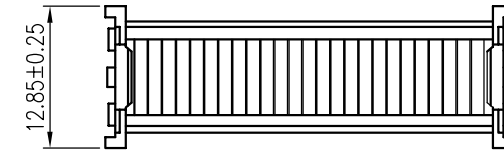
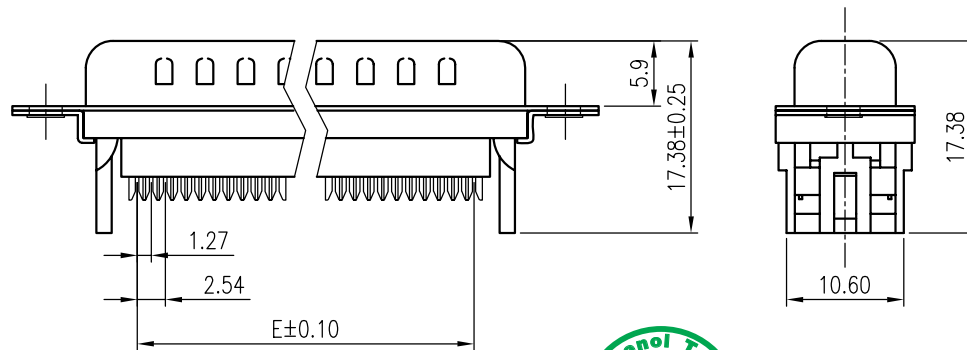
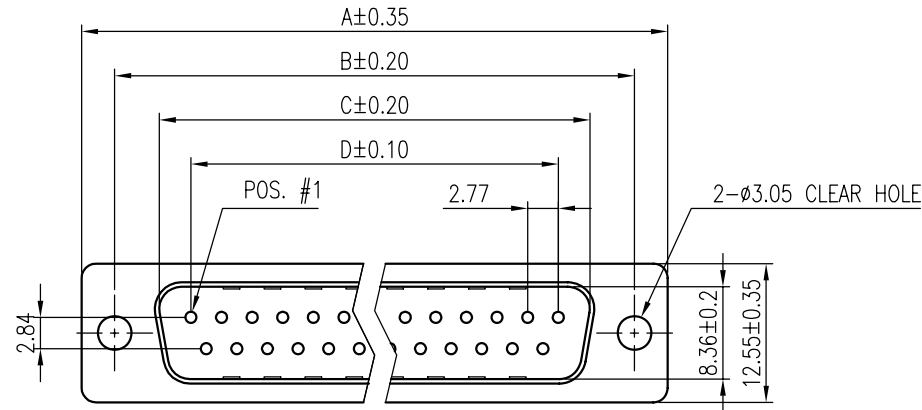

IDC COVER

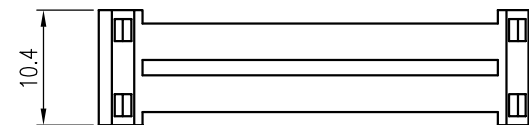
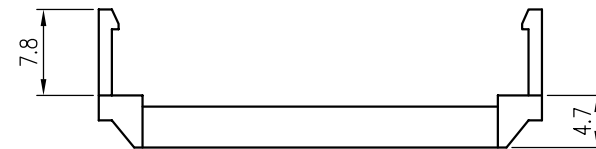

STRAIN RELIEF

NOTES:

1. INSULATOR: PBT, UL 94V-0, COLOR- BLACK
2. CONTACT: BRASS, SELECTIVE GOLD PLATED
3. SHELL: STEEL, TIN OR NICKEL OR ZINC CHROMATED PLATED
4. THIS PRODUCT DOESN'T CONTAIN ENVIRONMENTAL HAZARDOUS MATERIAL PER DIRECTIVE 2002/95/EC FOR RoHS.



37	69.40	63.50	55.42	49.86	45.72
25	53.05	47.04	38.96	33.24	30.48
15	39.20	33.32	25.50	19.39	17.78
9	30.80	24.99	16.92	11.08	10.16
NO. OF POS.	A	B	C	D	E

TOLERANCE m/m	APPROVALS	DATE	TITLE		<h2 style="margin: 0;">Amphenol®</h2> <p style="margin: 0;">Amphenol Corporation Amphenol Taiwan Corporation</p>
x. ±0.30	DRAWN		G17K SERIES FLAT RIBBON CABLE IDC D-SUB, PLUG MATEL SHELL		
x.x ±0.25	Sondra Sang	12/15/05			
x.xx ±0.15	CHECKED		SCALE N.A. SHEET 1 OF 1		
x.xxx ±0.08	Jack Liu	12/15/05			
ANGULAR ±2°	APPROVED		DRAWING NO.		
UNLESS OTHERWISE SPECIFIED	Jeff Liu	12/15/05	DSUB-G17KXX1XX001EU-25		REV. A
		UNIT	SIZE	G17K XX1X X001 EU	
		MM	A4		

PART NUMBER SYSTEM **PNS-17K** **Rev. D**

ORIGINAL

G17K XX XX XXX XX

D-subminiature IDC Termination

Number of Position

- 09: 09 positions
- 15: 15 positions
- 25: 25 positions
- 37: 37 positions
- 50: 50 positions
- :

Contact Style

- 0: Receptacle
- 1: Plug

Contact Finish

- 0: Flash gold
- 1: 15µ" gold
- 2: 30µ" gold
- 3: Full flash gold

Front Shell Finish

- 0: Zinc chromated
- 1: Tin over nickel
- 2: Nickel
- 3: Whole plastic type

Variation Code

- Blank: Standard
- E: For E type

Strain Relief Option

- 0: None
- 1: With plastic strain relief
- 2: With steel strain relief

Flange Mounting Option

- 0: φ3.05mm clear hole
- 1: #4-40 threaded hole
- 2: #4-40 threaded hole with #4-40UNC screwlock installed
- 3: #4-40 threaded hole with #4-40UNC screwlock bulk-packed
- 4: M3 threaded hole
- 5: M3 threaded hole with M3 screwlock installed
- 6: #4-40 threaded hole with M2.6 screwlock bulk-packed
- 7: #4-40 threaded screwlock clinched-mount installed

Bracket Options

- 0: Without insulator support
- 1: With insulator support



- ! All contacts are in 50µ" nickel underplate
- ! All specified numbers are minimum thickness of plating.
- ! The variation code may supersede some major specifications defined by this standard part number system
- ! For part number with a variation code. Please refer to the specific set of data sheets released for that

				TITLE		PRODUCT SERIES	
				G17K SERIES, PART NUMBER		G17K	
D	NE-05266	Henry Ko	08/30/2005	This document is the property of Amphenol Corporation and is delivered on the express condition that it is not to be disclosed, reproduced or used, in whole or in part, for manufacture or sale by anyone other than Amphenol Corporation without its prior consent, and that no right is granted to disclose or to use any information in this document.			
C	NE-00020	Arthur Huang	01/14/2000				
B	NE-99182	Arthur Huang	06/07/1999				
A		Arthur Huang	09/23/1997				
SYM	ECO NO.	APPROVED	DATE				
PREPARED		DATE		CHECKED		DATE	
Sondra sang		08/30/2005		Laura Su		08/30/2005	
				APPROVED		DATE	
				Ken Lin for		08/30/2005	