

GaAIAs-IR-Lumineszenzdiode (880 nm) in SMR® Gehäuse GaAIAs Infrared Emitters (880 nm) in SMR® Package

SFH 4580
SFH 4585



SFH 4580



SFH 4585

Wesentliche Merkmale

- GaAIAs-LED mit sehr hohem Wirkungsgrad
- SMR® (Surface Mount Radial) Gehäuse
- Für Oberflächenmontage geeignet
- Gegurtet lieferbar
- Gehäusegleich mit Fotodiode SFH 2500/ SFH 2505
- Hohe Zuverlässigkeit
- Gute spektrale Anpassung an Si-Fotoempfänger
- UL-Freigabe

Features

- Very highly efficient GaAIAs-LED
- SMR® (Surface Mount Radial) package
- Suitable for surface mounting (SMT)
- Available on tape and reel
- Same package as photodiode SFH 2500/ SFH 2505
- High reliability
- Spectral match with silicon photodetectors
- UL-approval

Anwendungen

- IR-Fernsteuerung von Fernseh- und Rundfunkgeräten, Videorecordern, Lichtdimmern
- Gerätefernsteuerungen für Gleich- und Wechsellichtbetrieb
- Sensorik
- Diskrete Lichtschranken
- Diskrete Optokoppler

Applications

- IR remote control of hi-fi and TV-sets, video tape recorders, dimmers
- Remote control for steady and varying intensity
- Sensor technology
- Discrete interrupters
- Discrete optocouplers

Typ Type	Bestellnummer Ordering Code	Strahlstärkegruppierung ¹⁾ ($I_F = 100\text{mA}$, $t_p = 20\text{ms}$) Radiant intensity grouping ¹⁾ I_e (mW/sr)
SFH 4580	Q62702-P1806	≥ 25
SFH 4585	Q62702-P1799	

¹⁾ gemessen bei einem Raumwinkel $\Omega = 0.01\text{ sr}$
measured at a solid angle of $\Omega = 0.01\text{ sr}$

Grenzwerte ($T_A = 25\text{ °C}$)**Maximum Ratings**

Bezeichnung Parameter	Symbol Symbol	Wert Value	Einheit Unit
Betriebs- und Lagertemperatur Operating and storage temperature range	$T_{op}; T_{stg}$	- 40 ... + 100	°C
Sperrspannung Reverse voltage	V_R	5	V
Durchlaßstrom Forward current	I_F	100	mA
Stoßstrom, $t_p = 10\text{ }\mu\text{s}$, $D = 0$ Surge current	I_{FSM}	2.5	A
Verlustleistung Power dissipation	P_{tot}	200	mW
Wärmewiderstand, freie Beinchenlänge max. 10 mm Thermal resistance, lead length between package bottom and PC-board max. 10 mm	R_{thJA}	375	K/W

Kennwerte ($T_A = 25\text{ °C}$)**Characteristics**

Bezeichnung Parameter	Symbol Symbol	Wert Value	Einheit Unit
Wellenlänge der Strahlung Wavelength at peak emission $I_F = 100\text{ mA}$	λ_{peak}	880	nm
Spektrale Bandbreite bei 50% von I_{rel} Spectral bandwidth at 50% of I_{rel} $I_F = 100\text{ mA}$	$\Delta\lambda$	80	nm
Abstrahlwinkel Half angle	φ	± 15	Grad deg.
Aktive Chipfläche Active chip area	A	0.09	mm ²
Abmessungen der aktiven Chipfläche Dimension of the active chip area	$L \times B$ $L \times W$	0.3×0.3	mm
Abstand Chipoberfläche bis Linsenscheitel Distance chip front to lens top	H	3.9 ... 4.5	mm

Kennwerte ($T_A = 25\text{ °C}$)

Characteristics (cont'd)

Bezeichnung Parameter	Symbol Symbol	Wert Value	Einheit Unit
Schaltzeiten, I_e von 10% auf 90% und von 90% auf 10%, bei $I_F = 100\text{ mA}$, $R_L = 50\ \Omega$ Switching times, I_e from 10% to 90% and from 90% to 10%, $I_F = 100\text{ mA}$, $R_L = 50\ \Omega$	t_r, t_f	0.6/0.5	μs
Kapazität Capacitance $V_R = 0\text{ V}$, $f = 1\text{ MHz}$	C_o	15	pF
Durchlaßspannung, Forward voltage $I_F = 100\text{ mA}$, $t_p = 20\text{ ms}$ $I_F = 1\text{ A}$, $t_p = 100\ \mu\text{s}$	V_F V_F	1.50 (≤ 1.8) 3.00 (≤ 3.8)	V V
Sperrstrom, Reverse current $V_R = 5\text{ V}$	I_R	0.01 (≤ 1)	μA
Gesamtstrahlungsfluß, Total radiant flux $I_F = 100\text{ mA}$, $t_p = 20\text{ ms}$	Φ_e	25	mW
Temperaturkoeffizient von I_e bzw. Φ_e , $I_F = 100\text{ mA}$ Temperature coefficient of I_e or Φ_e , $I_F = 100\text{ mA}$	TC_I	- 0.5	%/K
Temperaturkoeffizient von V_F , $I_F = 100\text{ mA}$ Temperature coefficient of V_F , $I_F = 100\text{ mA}$	TC_V	- 2	mV/K
Temperaturkoeffizient von λ , $I_F = 100\text{ mA}$ Temperature coefficient of λ , $I_F = 100\text{ mA}$	TC_λ	0.25	nm/K

Strahlstärke I_e in Achsrichtunggemessen bei einem Raumwinkel $\Omega = 0.01$ sr**Radiant Intensity I_e in Axial Direction**at a solid angle of $\Omega = 0.01$ sr

Bezeichnung Parameter	Symbol	Wert Value	Einheit Unit
Strahlstärke Radiant intensity $I_F = 100$ mA, $t_p = 20$ ms	$I_{e \text{ min}}$	≥ 25	mW/sr
Strahlstärke Radiant intensity $I_F = 1$ A, $t_p = 100$ μ s	$I_{e \text{ typ}}$	225	mW/sr

Relative Spectral Emission

$I_{rel} = f(\lambda)$

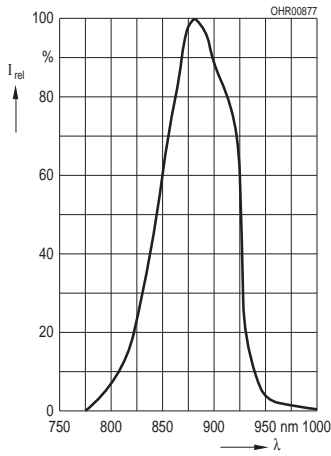

Radiant Intensity $\frac{I_e}{I_e 100 \text{ mA}} = f(I_F)$

Single pulse, $t_p = 20 \mu\text{s}$

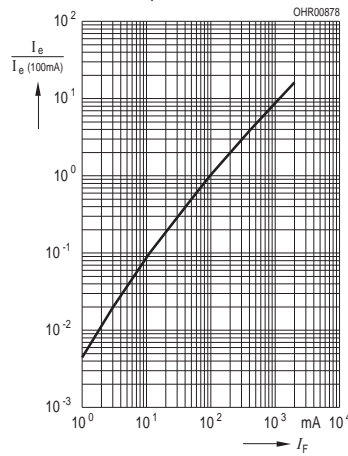

Max. Permissible Forward Current

$I_F = f(T_A)$

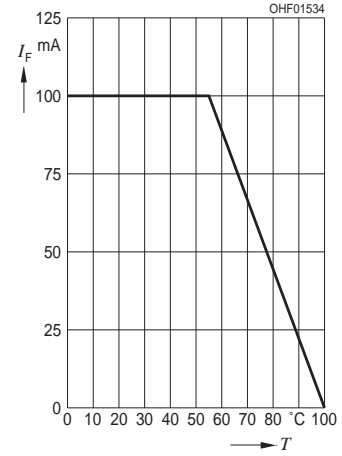

Forward Current

$I_F = f(V_F)$, single pulse, $t_p = 20 \mu\text{s}$

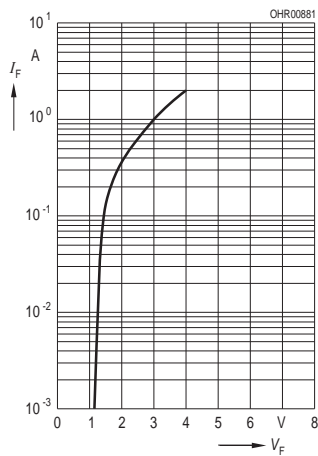

Permissible Pulse Handling Capability

$I_F = f(\tau)$, $T_A = 25 \text{ }^\circ\text{C}$, duty cycle $D =$ parameter

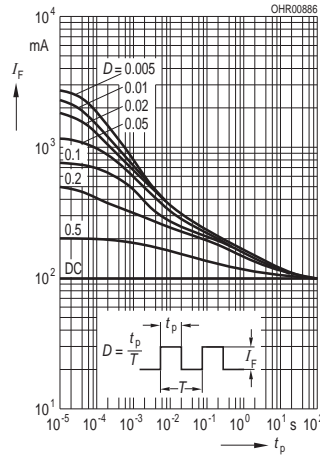

Forward Current vs. Lead Length between the Package Bottom and the PC-Board

$I_F = f(l)$, $T_A = 25 \text{ }^\circ\text{C}$

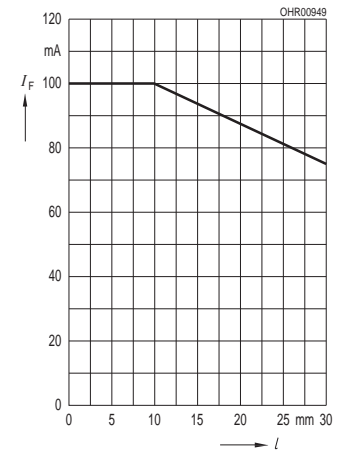

Radiation Characteristics $I_{rel} = f(\varphi)$

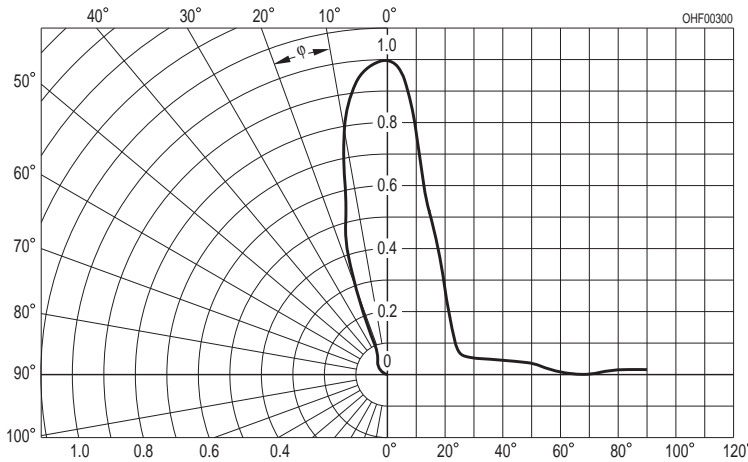

Maßzeichnung
Package Outlines

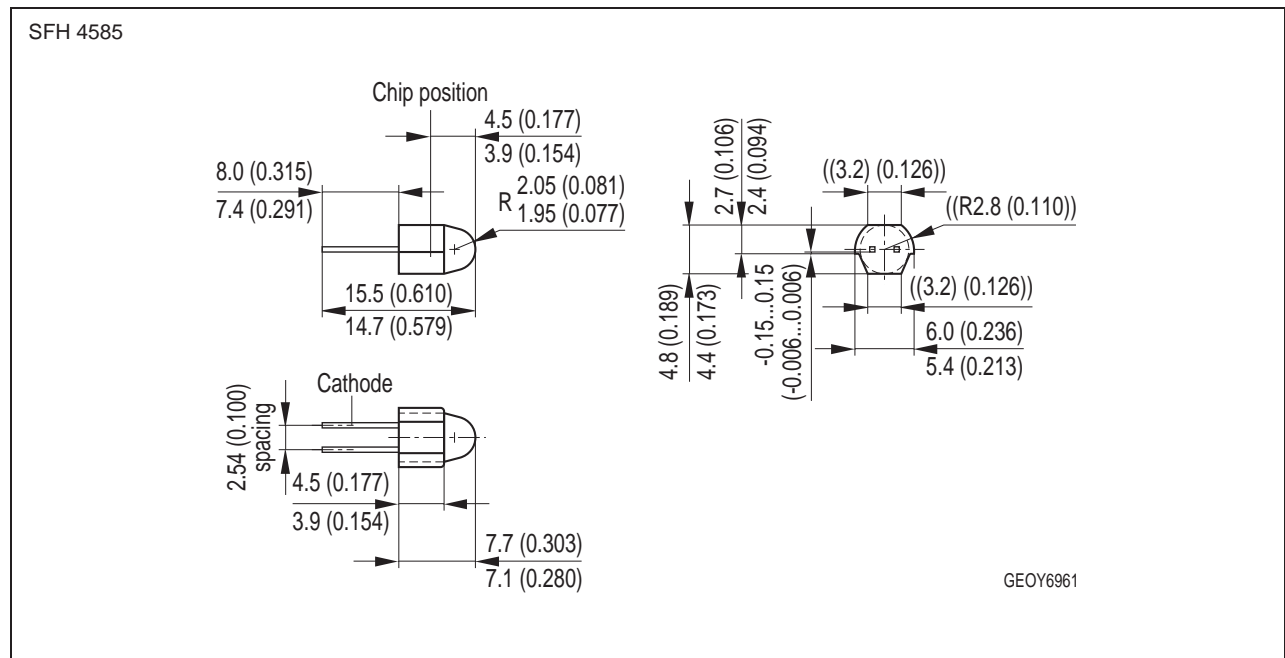
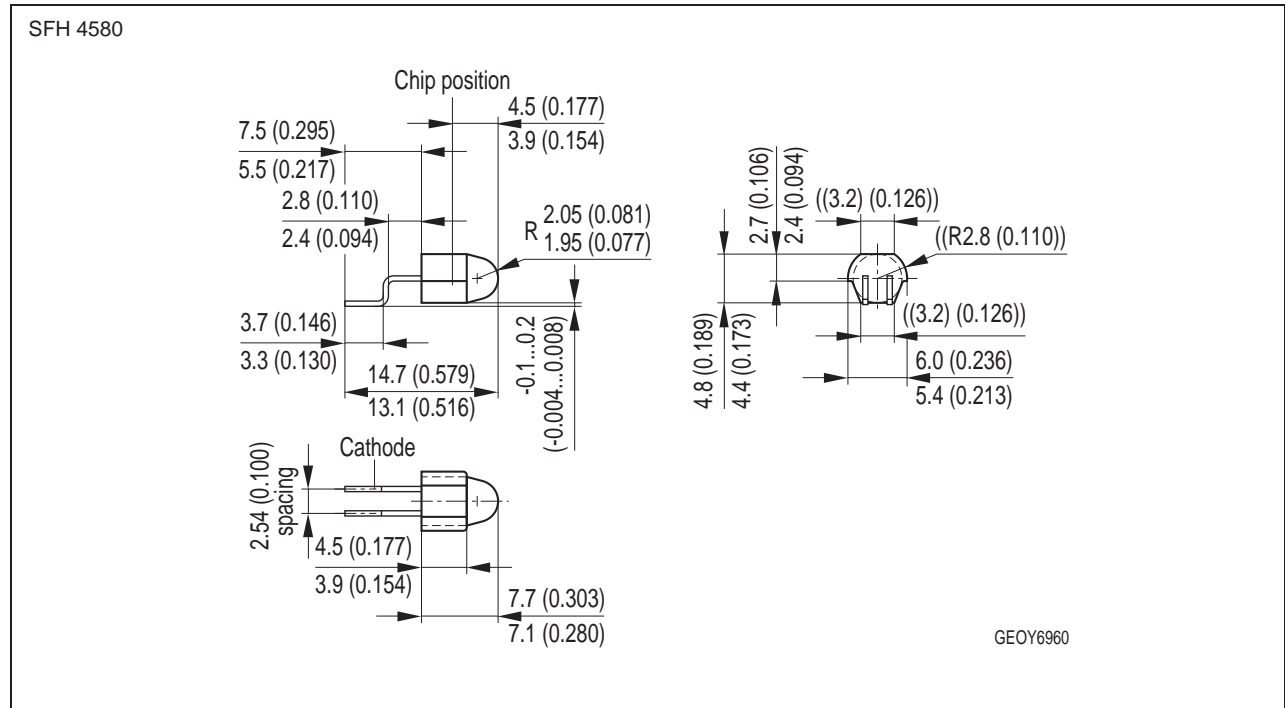

Maße werden wie folgt angegeben: mm (inch) / Dimensions are specified as follows: mm (inch).

**Published by OSRAM Opto Semiconductors GmbH & Co. OHG
Wernerwerkstrasse 2, D-93049 Regensburg**

© All Rights Reserved.

Attention please!

The information describes the type of component and shall not be considered as assured characteristics. Terms of delivery and rights to change design reserved. Due to technical requirements components may contain dangerous substances. For information on the types in question please contact our Sales Organization.

Packing

Please use the recycling operators known to you. We can also help you – get in touch with your nearest sales office. By agreement we will take packing material back, if it is sorted. You must bear the costs of transport. For packing material that is returned to us unsorted or which we are not obliged to accept, we shall have to invoice you for any costs incurred.

Components used in life-support devices or systems must be expressly authorized for such purpose! Critical components ¹, may only be used in life-support devices or systems ² with the express written approval of OSRAM OS.

¹ A critical component is a component used in a life-support device or system whose failure can reasonably be expected to cause the failure of that life-support device or system, or to affect its safety or effectiveness of that device or system.

² Life support devices or systems are intended (a) to be implanted in the human body, or (b) to support and/or maintain and sustain human life. If they fail, it is reasonable to assume that the health of the user may be endangered.