

DETAIL Z
POST DETAIL TYP
2 POST MINIMUM

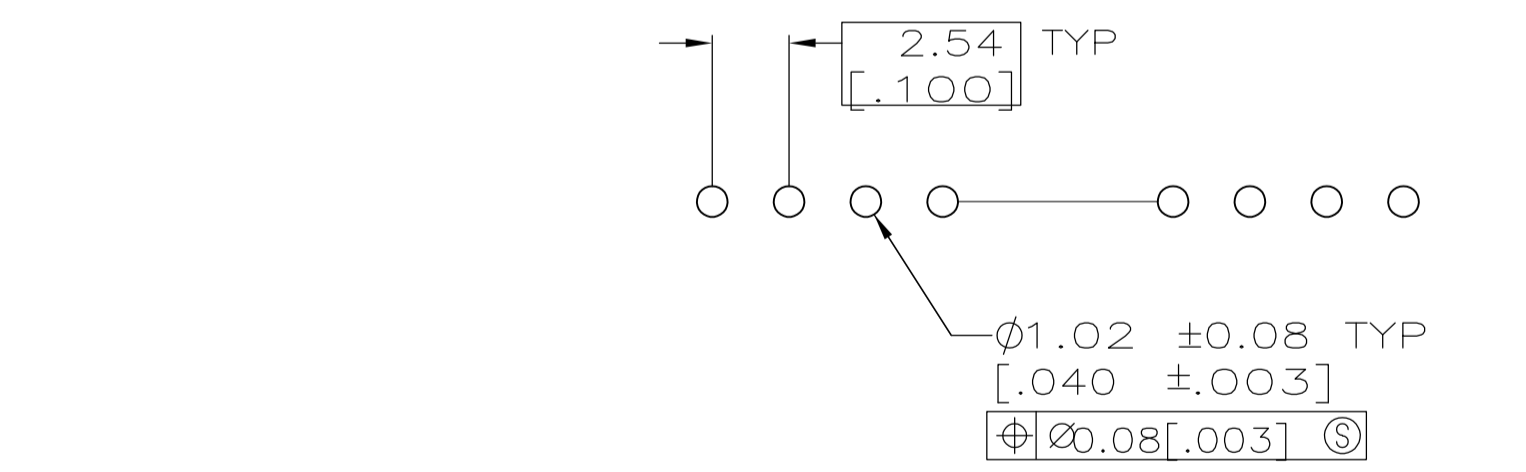
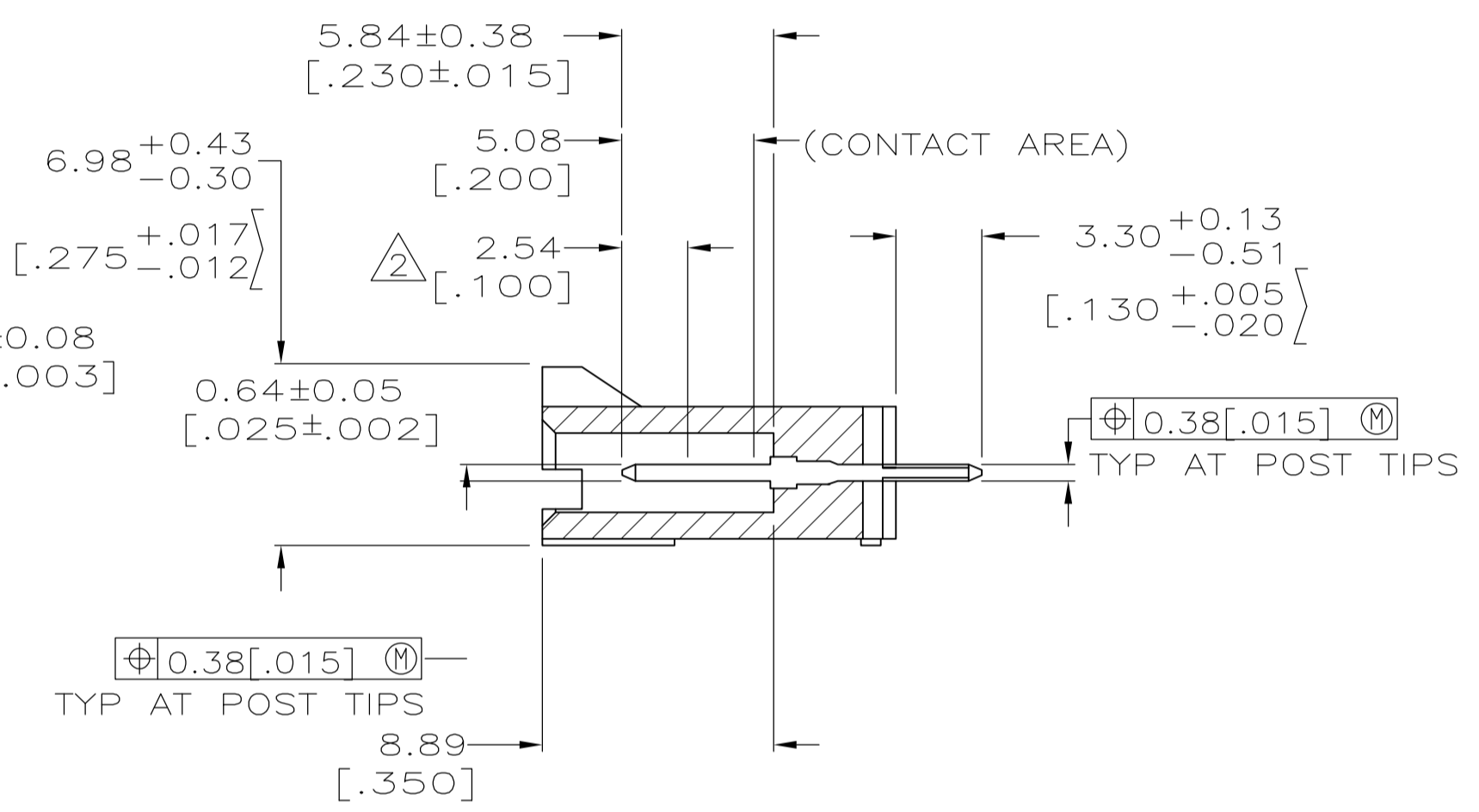

RECOMMENDED HOLE LAYOUT

- ① .000100 BRIGHT TIN-LEAD OVER .000050 NICKEL.
- ② POINT OF MEASUREMENT FOR PLATING THICKNESS.
- ③ THE NOTED DIMENSIONS APPLY AT THE INTERSECTION OF THE POST AND THE HOUSING.
- ④ ON ASSEMBLIES WITH FOUR OR MORE POSITIONS, TWO POLARIZATION SLOTS. ON ASSEMBLIES WITH TWO OR THREE POSITIONS, ONE POLARIZATION SLOT.
- ⑤ SELECT POST TAILS FORMED TO PROVIDE CONNECTOR HOLD DOWN UNTIL SOLDERED. CONFIGURATION ACCEPTS 0.69[.027]-2.03[.080] THICK PRINTED CIRCUIT BOARD. (SEE DETAIL Z).
- ⑥ .000100 BRIGHT TIN OVER .000050 NICKEL.
- ⑦ PRELIMINARY PART - NOT RELEASED FOR PRODUCTION.
- ⑧ .000100 MATTE TIN OVER .000050 NICKEL.
- ⑨ HIGH TEMPERATURE CONFIGURATION.
- ⑩ STANDOFFS NOT PRESENT ON UNDERSIDE OF ASSEMBLY
- ⑪ OBSOLETE PARTS: OBSOLETE CIS STREAMLINING PER D.RENAUD/D.SINISI

⑥	23.37 [.920]	25.40 [1.000]	8	9	3-103669-0
⑥	8.13 [.320]	10.16 [.400]	2	3	2-103669-9
⑥	15.75 [.620]	17.78 [.700]	5	6	2-103669-8
⑥	13.21 [.520]	15.24 [.600]	4	5	2-103669-7
⑥	10.67 [.420]	12.70 [.500]	3	4	2-103669-6
⑥	5.59 [.220]	7.62 [.300]	1	2	2-103669-5
①①	64.01 [2.520]	66.04 [2.600]	24	25	2-103669-4
①①	61.47 [2.420]	63.50 [2.500]	23	24	2-103669-3
①①	58.93 [2.320]	60.96 [2.400]	22	23	2-103669-2
①①	56.39 [2.220]	58.42 [2.300]	21	22	2-103669-1
①①	53.85 [2.120]	55.88 [2.200]	20	21	2-103669-0
①	51.31 [2.020]	53.34 [2.100]	19	20	1-103669-9
①①	48.77 [1.920]	50.80 [2.000]	18	19	1-103669-8
①①	46.23 [1.820]	48.26 [1.900]	17	18	1-103669-7
①	43.69 [1.720]	45.72 [1.800]	16	17	1-103669-6
①	41.15 [1.620]	43.18 [1.700]	15	16	1-103669-5
①①	38.61 [1.520]	40.64 [1.600]	14	15	1-103669-4
①	36.07 [1.420]	38.10 [1.500]	13	14	1-103669-3
①	33.53 [1.320]	35.56 [1.400]	12	13	1-103669-2
①	30.99 [1.220]	33.02 [1.300]	11	12	1-103669-1
①	28.45 [1.120]	30.48 [1.200]	10	11	1-103669-0
①	25.91 [1.020]	27.94 [1.100]	9	10	103669-9
①	23.37 [.920]	25.40 [1.000]	8	9	103669-8
①	20.83 [.820]	22.86 [.900]	7	8	103669-7
①	18.29 [.720]	20.32 [.800]	6	7	103669-6
①	15.75 [.620]	17.78 [.700]	5	6	103669-5
①	13.21 [.520]	15.24 [.600]	4	5	103669-4
①	10.67 [.420]	12.70 [.500]	3	4	103669-3
①	8.13 [.320]	10.16 [.400]	2	3	103669-2
①	5.59 [.220]	7.62 [.300]	1	2	103669-1
PLATING	C	B	A	NO. OF POSN	PART NO.

THIS DRAWING IS A CONTROLLED DOCUMENT.











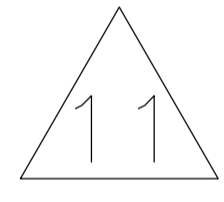



















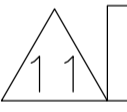









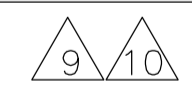

DIMENSIONS: INCHES	TOLERANCES UNLESS OTHERWISE SPECIFIED:	DIN S. SHUEY 3-5-91	3-5-91
0 PLC ± -	1 PLC ± -	2-14-92	2-14-92
2 PLC ± ± 0.13[.005]	3 PLC ± ± -	M. RIDER 2-14-92	M. RIDER 2-14-92
4 PLC ± ± -	ANGLES ± ± -	NAME	NAME

APVD: M. RIDER
PRODUCT SPEC: 108-25034
APPLICATION SPEC: 114-25026

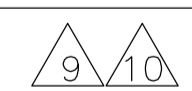
SIZE: A1
CAGE CODE: 00779
DRAWING NO: 103669
RESTRICTED TO: -

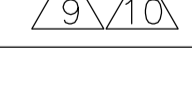
CUSTOMER DRAWING
SCALE: 4:1
SHEET: 1 OF 2
REV: AA2

STE TE Connectivity
HDR ASSY, VERT, SINGLE ROW
2.54 [100] C/L 0.64 [025] SQ POST
WITH PLZN, AMPMODU MTE

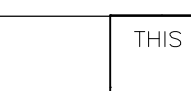
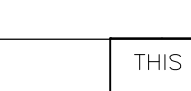
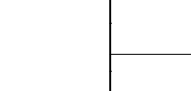
<p>OBSOLETE</p> 			64.01 [2.520]	66.04 [2.600]	24	25	7-103669-4
			61.47 [2.420]	63.50 [2.500]	23	24	7-103669-3
			58.93 [2.320]	60.96 [2.400]	22	23	7-103669-2
			56.39 [2.220]	58.42 [2.300]	21	22	7-103669-1
			53.85 [2.120]	55.88 [2.200]	20	21	7-103669-0
			51.31 [2.020]	53.34 [2.100]	19	20	6-103669-9
			48.77 [1.920]	50.80 [2.000]	18	19	6-103669-8
			46.23 [1.820]	48.26 [1.900]	17	18	6-103669-7
			43.69 [1.720]	45.72 [1.800]	16	17	6-103669-6
			41.15 [1.620]	43.18 [1.700]	15	16	6-103669-5
			38.61 [1.520]	40.64 [1.600]	14	15	6-103669-4
			36.07 [1.420]	38.10 [1.500]	13	14	6-103669-3
			33.53 [1.320]	35.56 [1.400]	12	13	6-103669-2
			30.99 [1.220]	33.02 [1.300]	11	12	6-103669-1
			28.45 [1.120]	30.48 [1.200]	10	11	6-103669-0
			25.91 [1.020]	27.94 [1.100]	9	10	5-103669-9
			23.37 [.920]	25.40 [1.000]	8	9	5-103669-8
			20.83 [.820]	22.86 [.900]	7	8	5-103669-7
			18.29 [.720]	20.32 [.800]	6	7	5-103669-6
			15.75 [.620]	17.78 [.700]	5	6	5-103669-5
		13.21 [.520]	15.24 [.600]	4	5	5-103669-4	
		10.67 [.420]	12.70 [.500]	3	4	5-103669-3	
		8.13 [.320]	10.16 [.400]	2	3	5-103669-2	
		5.59 [.220]	7.62 [.300]	1	2	5-103669-1	
REMARKS	PLATING	C	B	A	NO. OF POSN	PART NO.	

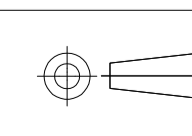
THIS DRAWING IS A CONTROLLED DOCUMENT.		DSN S. SHUEY 3-5-91 CHK M. RIDER 2-14-92 APVD M. RIDER 2-14-92	 TE Connectivity	
DIMENSIONS: INCHES 	TOLERANCES UNLESS OTHERWISE SPECIFIED: 0. PLC ± - 1. PLC ± - 2. PLC ± 0.13[.005] 3. PLC ± - 4. PLC ± - ANGLES ± -	NAME: HDR ASSY, VERT, SINGLE ROW PRODUCT SPEC: 108-25034 APPLICATION SPEC: 114-25026	SIZE: A1 CAGE CODE: 00779 DRAWING NO: 103669	RESTRICTED TO: - SCALE: 4:1 SHEET: 2 OF 2 REV: AA2
MATERIAL HOUSING: SEE TABLE	WEIGHT: -	CUSTOMER DRAWING		