



Is Now Part of



**ON Semiconductor®**

To learn more about ON Semiconductor, please visit our website at  
[www.onsemi.com](http://www.onsemi.com)

ON Semiconductor and the ON Semiconductor logo are trademarks of Semiconductor Components Industries, LLC dba ON Semiconductor or its subsidiaries in the United States and/or other countries. ON Semiconductor owns the rights to a number of patents, trademarks, copyrights, trade secrets, and other intellectual property. A listing of ON Semiconductor's product/patent coverage may be accessed at [www.onsemi.com/site/pdf/Patent-Marking.pdf](http://www.onsemi.com/site/pdf/Patent-Marking.pdf). ON Semiconductor reserves the right to make changes without further notice to any products herein. ON Semiconductor makes no warranty, representation or guarantee regarding the suitability of its products for any particular purpose, nor does ON Semiconductor assume any liability arising out of the application or use of any product or circuit, and specifically disclaims any and all liability, including without limitation special, consequential or incidental damages. Buyer is responsible for its products and applications using ON Semiconductor products, including compliance with all laws, regulations and safety requirements or standards, regardless of any support or applications information provided by ON Semiconductor. "Typical" parameters which may be provided in ON Semiconductor data sheets and/or specifications can and do vary in different applications and actual performance may vary over time. All operating parameters, including "Typicals" must be validated for each customer application by customer's technical experts. ON Semiconductor does not convey any license under its patent rights nor the rights of others. ON Semiconductor products are not designed, intended, or authorized for use as a critical component in life support systems or any FDA Class 3 medical devices or medical devices with a same or similar classification in a foreign jurisdiction or any devices intended for implantation in the human body. Should Buyer purchase or use ON Semiconductor products for any such unintended or unauthorized application, Buyer shall indemnify and hold ON Semiconductor and its officers, employees, subsidiaries, affiliates, and distributors harmless against all claims, costs, damages, and expenses, and reasonable attorney fees arising out of, directly or indirectly, any claim of personal injury or death associated with such unintended or unauthorized use, even if such claim alleges that ON Semiconductor was negligent regarding the design or manufacture of the part. ON Semiconductor is an Equal Opportunity/Affirmative Action Employer. This literature is subject to all applicable copyright laws and is not for resale in any manner.



# FDMS7620S

## Dual N-Channel PowerTrench<sup>®</sup> MOSFET

Q1: 30 V, 13 A, 20.0 mΩ Q2: 30 V, 22 A, 11.2 mΩ

### Features

Q1: N-Channel

- Max  $r_{DS(on)}$  = 20.0 mΩ at  $V_{GS} = 10\text{ V}$ ,  $I_D = 10.1\text{ A}$
- Max  $r_{DS(on)}$  = 30.0 mΩ at  $V_{GS} = 4.5\text{ V}$ ,  $I_D = 7.5\text{ A}$

Q2: N-Channel

- Max  $r_{DS(on)}$  = 11.2 mΩ at  $V_{GS} = 10\text{ V}$ ,  $I_D = 12.4\text{ A}$
- Max  $r_{DS(on)}$  = 14.2 mΩ at  $V_{GS} = 4.5\text{ V}$ ,  $I_D = 10.9\text{ A}$
- Pinout optimized for simple PCB design
- Thermally efficient dual Power 56 Package
- RoHS Compliant



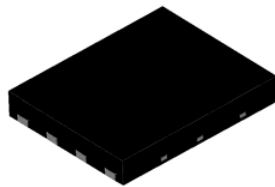
### General Description

This device includes two specialized MOSFETs in a unique dual Power 56 package. It is designed to provide an optimal synchronous buck power stage in terms of efficiency and PCB utilization. The low switching loss “High Side” MOSFET is complementary by a low conduction loss “Low Side” SyncFET.

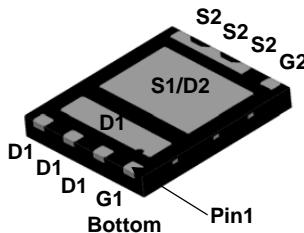
### Applications

Synchronous Buck Converter for:

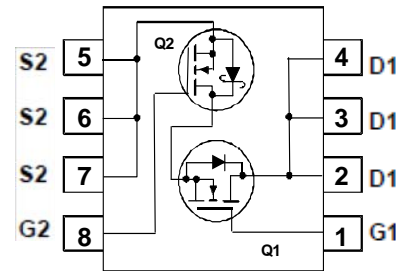
- Notebook System Power
- General Purpose Point of Load



Top



Power 56



### MOSFET Maximum Ratings $T_A = 25^\circ\text{C}$ unless otherwise noted

Symbol	Parameter	Q1	Q2	Units
$V_{DS}$	Drain to Source Voltage	30	30	V
$V_{GS}$	Gate to Source Voltage (Note 3)	$\pm 20$	$\pm 20$	V
$I_D$	Drain Current -Continuous $T_C = 25^\circ\text{C}$	13	22	A
	-Continuous $T_A = 25^\circ\text{C}$	10.1	12.4	
	-Pulsed	27	45	
$E_{AS}$	Single Pulse Avalanche Energy (Note 4)	9	21	mJ
$P_D$	Power Dissipation for Single Operation $T_A = 25^\circ\text{C}$	2.2 <sup>1a</sup>	2.5 <sup>1b</sup>	W
	Power Dissipation for Single Operation $T_A = 25^\circ\text{C}$	1.0 <sup>1c</sup>	1.0 <sup>1d</sup>	
$T_J, T_{STG}$	Operating and Storage Junction Temperature Range	-55 to +150		$^\circ\text{C}$

### Thermal Characteristics

$R_{\theta JA}$	Thermal Resistance, Junction to Ambient	57 <sup>1a</sup>	50 <sup>1b</sup>	$^\circ\text{C/W}$
$R_{\theta JA}$	Thermal Resistance, Junction to Ambient	125 <sup>1c</sup>	120 <sup>1d</sup>	

### Package Marking and Ordering Information

Device Marking	Device	Package	Reel Size	Tape Width	Quantity
FDMS7620S	FDMS7620S	Power 56	13"	12 mm	3000 units

**Electrical Characteristics**  $T_J = 25^\circ\text{C}$  unless otherwise noted

Symbol	Parameter	Test Conditions	Type	Min	Typ	Max	Units
--------	-----------	-----------------	------	-----	-----	-----	-------

**Off Characteristics**

$BV_{DSS}$	Drain to Source Breakdown Voltage	$I_D = 250 \mu\text{A}, V_{GS} = 0 \text{ V}$ $I_D = 1 \text{ mA}, V_{GS} = 0 \text{ V}$	Q1 Q2	30 30			V
$\frac{\Delta BV_{DSS}}{\Delta T_J}$	Breakdown Voltage Temperature Coefficient	$I_D = 250 \mu\text{A}$ , referenced to $25^\circ\text{C}$ $I_D = 10 \text{ mA}$ , referenced to $25^\circ\text{C}$	Q1 Q2		19 19		mV/ $^\circ\text{C}$
$I_{DSS}$	Zero Gate Voltage Drain Current	$V_{DS} = 24 \text{ V}, V_{GS} = 0 \text{ V}$	Q1 Q2			1 500	$\mu\text{A}$
$I_{GSS}$	Gate to Source Leakage Current, Forward	$V_{GS} = 20 \text{ V}, V_{DS} = 0 \text{ V}$	Q1 Q2			100 100	nA

**On Characteristics**

$V_{GS(th)}$	Gate to Source Threshold Voltage	$V_{GS} = V_{DS}, I_D = 250 \mu\text{A}$ $V_{GS} = V_{DS}, I_D = 1 \text{ mA}$	Q1 Q2	1.0 1.0	2.2 2.0	3.0 3.0	V
$\frac{\Delta V_{GS(th)}}{\Delta T_J}$	Gate to Source Threshold Voltage Temperature Coefficient	$I_D = 250 \mu\text{A}$ , referenced to $25^\circ\text{C}$ $I_D = 10 \text{ mA}$ , referenced to $25^\circ\text{C}$	Q1 Q2		-6 -5		mV/ $^\circ\text{C}$
$r_{DS(on)}$	Static Drain to Source On Resistance	$V_{GS} = 10 \text{ V}, I_D = 10.1 \text{ A}$ $V_{GS} = 4.5 \text{ V}, I_D = 7.5 \text{ A}$ $V_{GS} = 10 \text{ V}, I_D = 10 \text{ A}, T_J = 125^\circ\text{C}$	Q1		15.2 22.7 18.7	20.0 30.0 22.5	m $\Omega$
		$V_{GS} = 10 \text{ V}, I_D = 12.4 \text{ A}$ $V_{GS} = 4.5 \text{ V}, I_D = 10.9 \text{ A}$ $V_{GS} = 10 \text{ V}, I_D = 12.4 \text{ A}, T_J = 125^\circ\text{C}$	Q2		8.3 10.5 8.9	11.2 14.2 15.1	
$g_{FS}$	Forward Transconductance	$V_{DD} = 5 \text{ V}, I_D = 10.1 \text{ A}$ $V_{DD} = 5 \text{ V}, I_D = 12.4 \text{ A}$	Q1 Q2		22 53		S

**Dynamic Characteristics**

$C_{iss}$	Input Capacitance	$V_{DS} = 15 \text{ V}, V_{GS} = 0 \text{ V}, f = 1 \text{ MHz}$	Q1 Q2		457 1050	608 1400	pF
$C_{oss}$	Output Capacitance		Q1 Q2		167 358	222 477	pF
$C_{riss}$	Reverse Transfer Capacitance		Q1 Q2		22 35	31 49	pF
$R_g$	Gate Resistance		Q1 Q2	0.2 0.2	1.6 1.2	4.4 3.5	$\Omega$

**Switching Characteristics**

$t_{d(on)}$	Turn-On Delay Time	Q1 $V_{DD} = 15 \text{ V}, I_D = 10.1 \text{ A}, R_{GEN} = 6 \Omega$	Q1 Q2		5.2 6.6	10 14	ns
$t_r$	Rise Time		Q1 Q2		1.2 1.8	10 10	ns
$t_{d(off)}$	Turn-Off Delay Time	Q2 $V_{DD} = 15 \text{ V}, I_D = 12.4 \text{ A}, R_{GEN} = 6 \Omega$	Q1 Q2		11.9 17.4	22 32	ns
$t_f$	Fall Time		Q1 Q2		1.4 1.5	10 10	ns
$Q_{g(TOT)}$	Total Gate Charge	$V_{GS} = 0\text{V to } 10 \text{ V}$	Q1 Q2		7.2 15.6	11 23	nC
$Q_{g(TOT)}$	Total Gate Charge	$V_{GS} = 0\text{V to } 5 \text{ V}$			Q1 Q2		3.8 7.9
$Q_{gs}$	Gate to Source Charge	Q2 $V_{DD} = 15 \text{ V}, I_D = 12.4 \text{ A}$	Q1 Q2		1.6 3.2		nC
$Q_{gd}$	Gate to Drain "Miller" Charge		Q1 Q2		1.1 1.6		nC

## Electrical Characteristics $T_J = 25^\circ\text{C}$ unless otherwise noted

Symbol	Parameter	Test Conditions	Type	Min	Typ	Max	Units
--------	-----------	-----------------	------	-----	-----	-----	-------

### Drain-Source Diode Characteristics

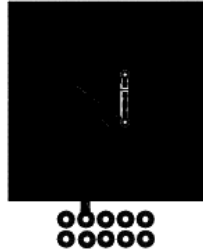
$V_{SD}$	Source-Drain Diode Forward Voltage	$V_{GS} = 0\text{ V}, I_S = 10.1\text{ A}$ (Note 2) $V_{GS} = 0\text{ V}, I_S = 12.4\text{ A}$ (Note 2)	Q1 Q2		0.90 0.83	1.2 1.2	V
$t_{rr}$	Reverse Recovery Time	Q1 $I_F = 10.1\text{ A}, di/dt = 100\text{ A/s}$	Q1 Q2		16 18	28 32	ns
$Q_{rr}$	Reverse Recovery Charge	Q2 $I_F = 12.4\text{ A}, di/dt = 300\text{ A/s}$	Q1 Q2		4 13	10 23	nC

#### Notes:

- $R_{\theta JA}$  is determined with the device mounted on a 1 in<sup>2</sup> pad 2 oz copper pad on a 1.5 x 1.5 in. board of FR-4 material.  $R_{\theta JC}$  is guaranteed by design while  $R_{\theta CA}$  is determined by the user's board design.



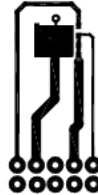
a. 57 °C/W when mounted on a 1 in<sup>2</sup> pad of 2 oz copper



b. 50 °C/W when mounted on a 1 in<sup>2</sup> pad of 2 oz copper



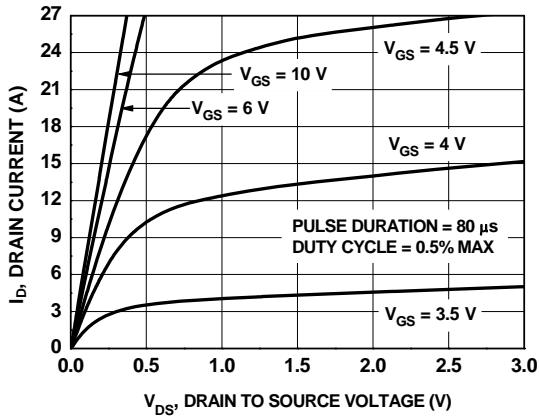
c. 125 °C/W when mounted on a minimum pad of 2 oz copper



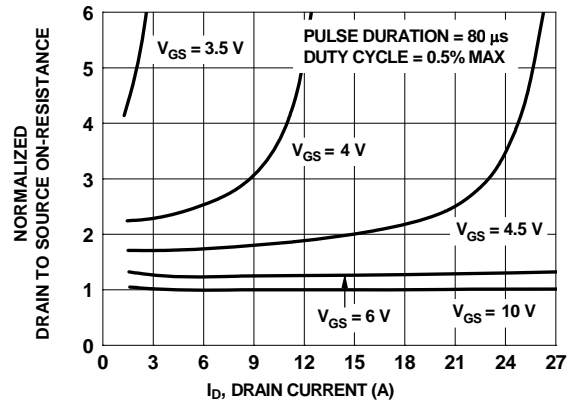
d. 120 °C/W when mounted on a minimum pad of 2 oz copper

- Pulse Test: Pulse Width < 300  $\mu\text{s}$ , Duty cycle < 2.0%.
- As an N-ch device, the negative  $V_{GS}$  rating is for low duty cycle pulse occurrence only. No continuous rating is implied.
- Q1:  $E_{AS}$  of 9 mJ is based on starting  $T_J = 25^\circ\text{C}$ ,  $L = 0.3\text{ mH}$ ,  $I_{AS} = 8\text{ A}$ ,  $V_{DD} = 27\text{ V}$ ,  $V_{GS} = 10\text{ V}$ . 100% test at  $L = 0.1\text{ mH}$ ,  $I_{AS} = 12\text{ A}$ .  
Q2:  $E_{AS}$  of 21 mJ is based on starting  $T_J = 25^\circ\text{C}$ ,  $L = 0.3\text{ mH}$ ,  $I_{AS} = 12\text{ A}$ ,  $V_{DD} = 27\text{ V}$ ,  $V_{GS} = 10\text{ V}$ . 100% test at  $L = 0.1\text{ mH}$ ,  $I_{AS} = 18\text{ A}$ .

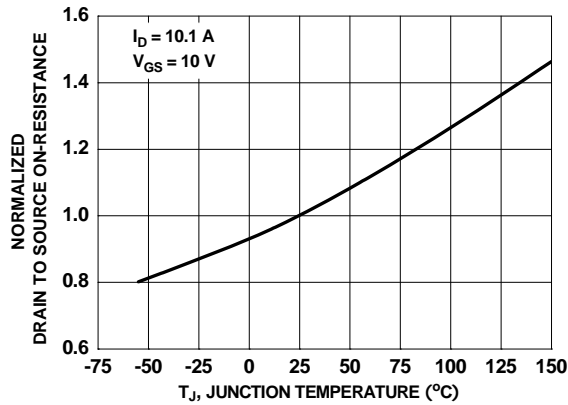
**Typical Characteristics (Q1 N-Channel)**  $T_J = 25^\circ\text{C}$  unless otherwise noted



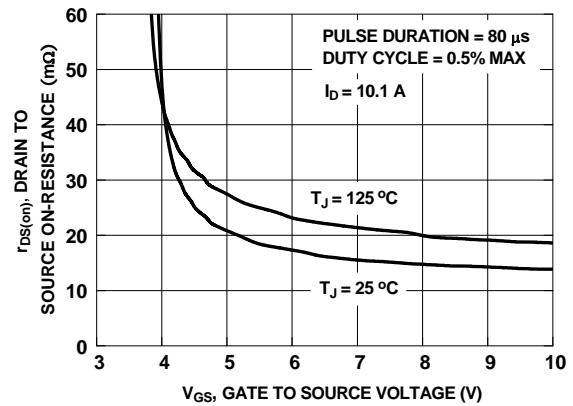
**Figure 1. On Region Characteristics**



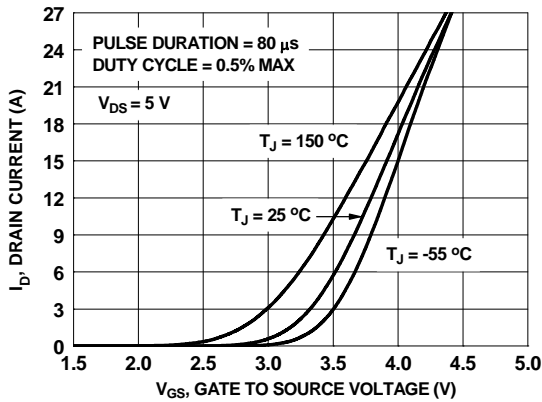
**Figure 2. Normalized On-Resistance vs Drain Current and Gate Voltage**



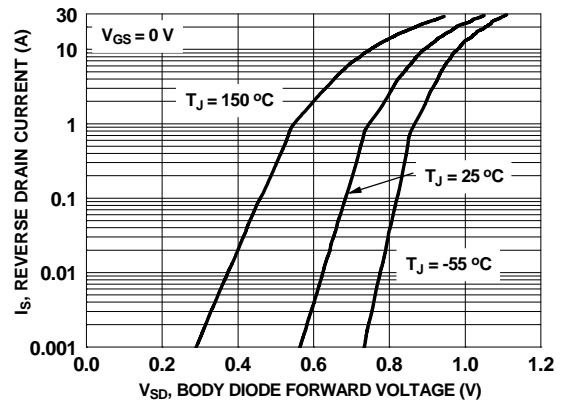
**Figure 3. Normalized On Resistance vs Junction Temperature**



**Figure 4. On-Resistance vs Gate to Source Voltage**

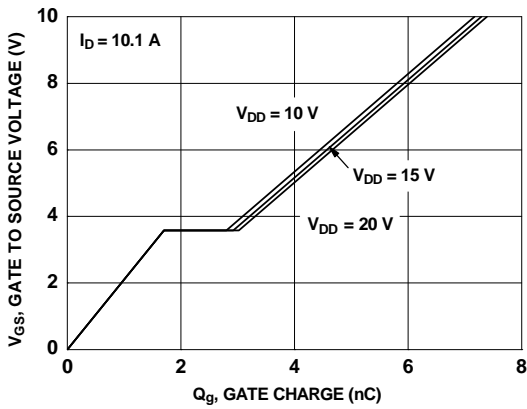


**Figure 5. Transfer Characteristics**

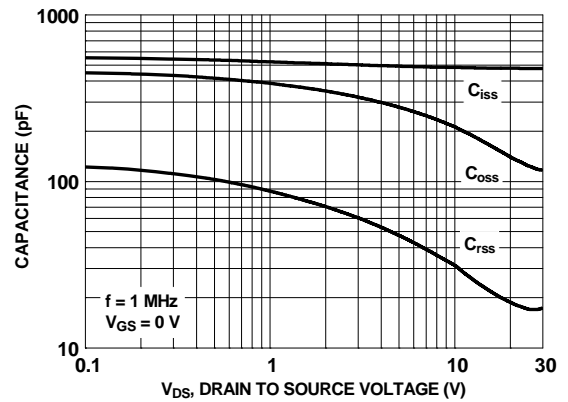


**Figure 6. Source to Drain Diode Forward Voltage vs Source Current**

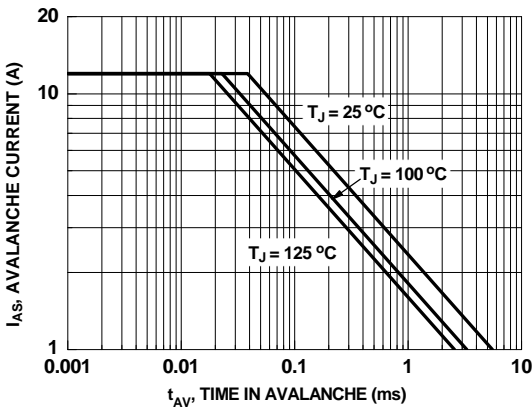
**Typical Characteristics (Q1 N-Channel)**  $T_J = 25^\circ\text{C}$  unless otherwise noted



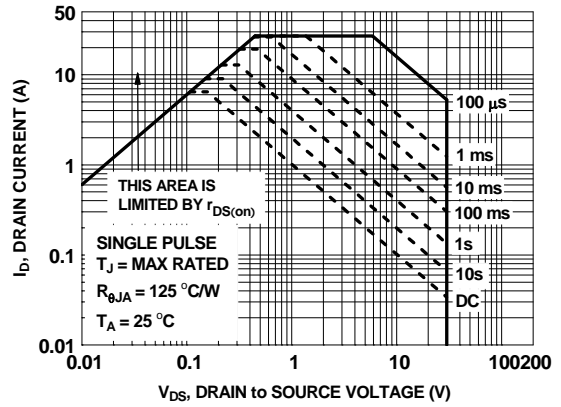
**Figure 7. Gate Charge Characteristics**



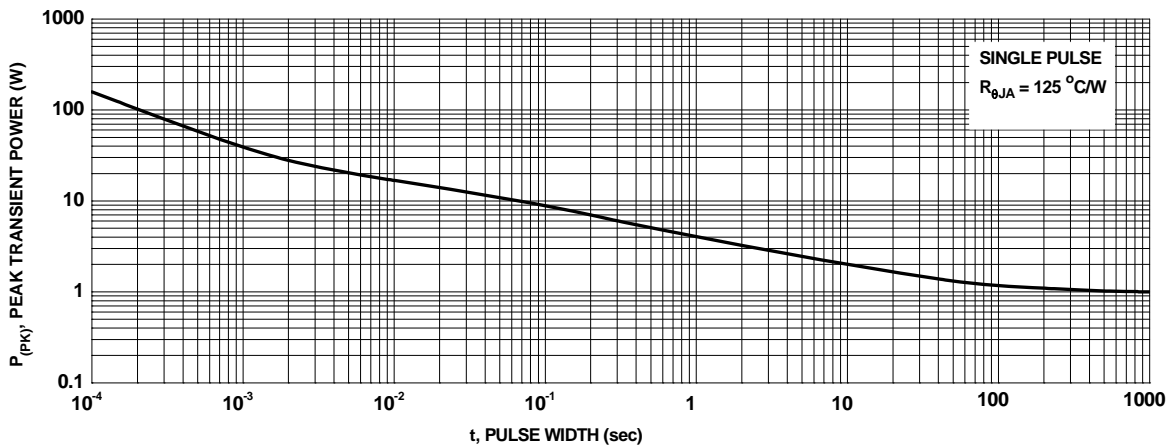
**Figure 8. Capacitance vs Drain to Source Voltage**



**Figure 9. Unclamped Inductive Switching Capability**

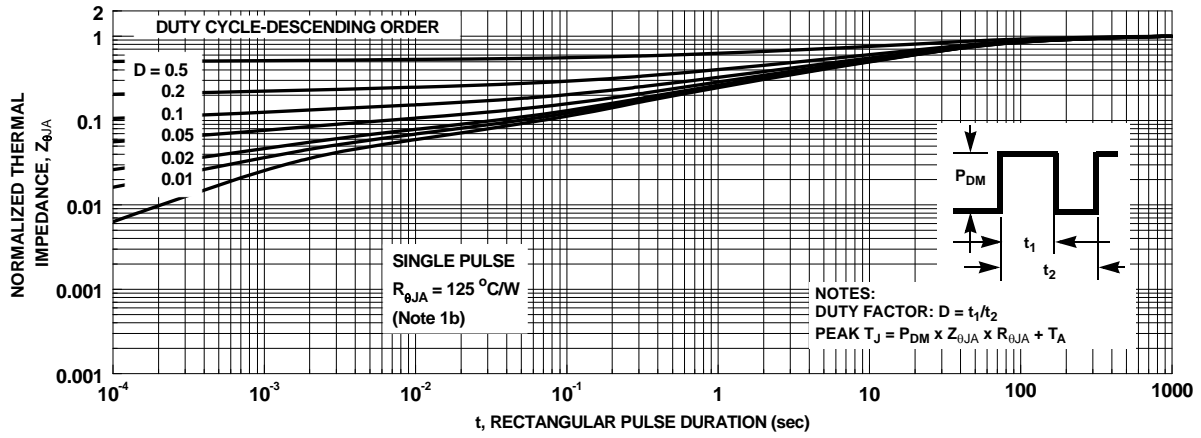


**Figure 10. Forward Bias Safe Operating Area**



**Figure 11. Single Pulse Maximum Power Dissipation**

**Typical Characteristics (Q1 N-Channel)**  $T_J = 25^\circ\text{C}$  unless otherwise noted



**Figure 12. Junction-to-Ambient Transient Thermal Response Curve**

**Typical Characteristics (Q2 N-Channel)**  $T_J = 25\text{ }^\circ\text{C}$  unless otherwise noted

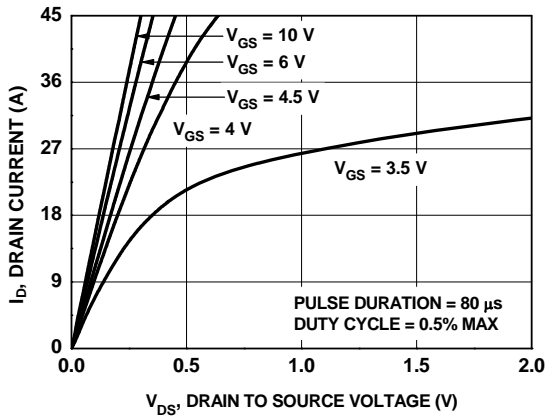


Figure 13. On-Region Characteristics

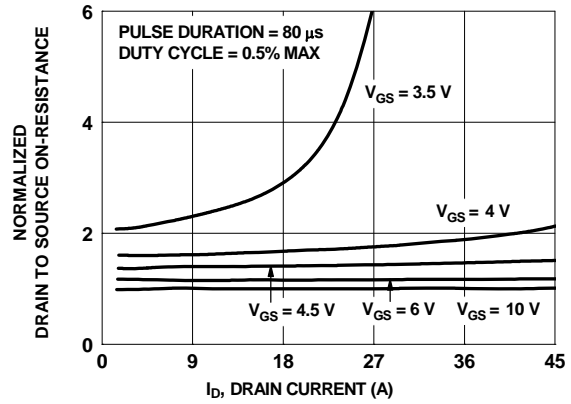


Figure 14. Normalized on-Resistance vs Drain Current and Gate Voltage

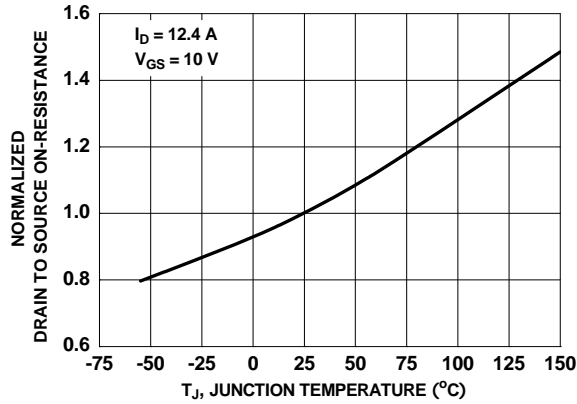


Figure 15. Normalized On-Resistance vs Junction Temperature

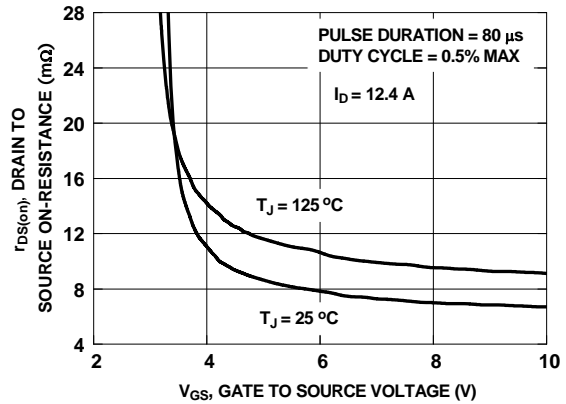


Figure 16. On-Resistance vs Gate to Source Voltage

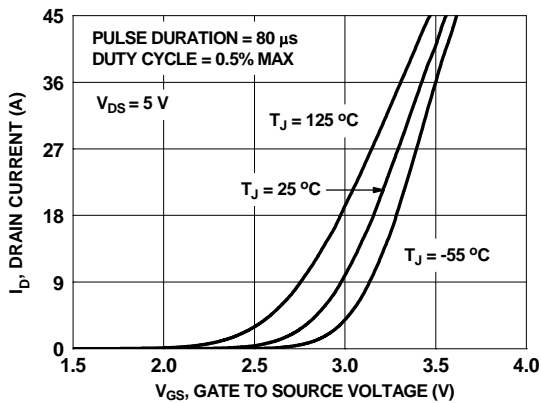


Figure 17. Transfer Characteristics

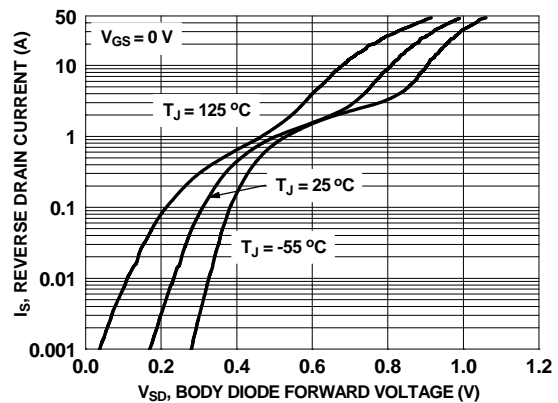
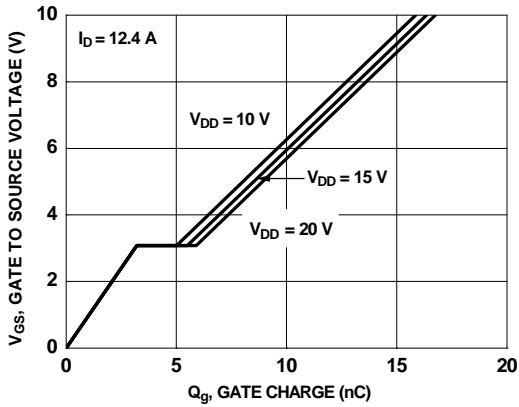


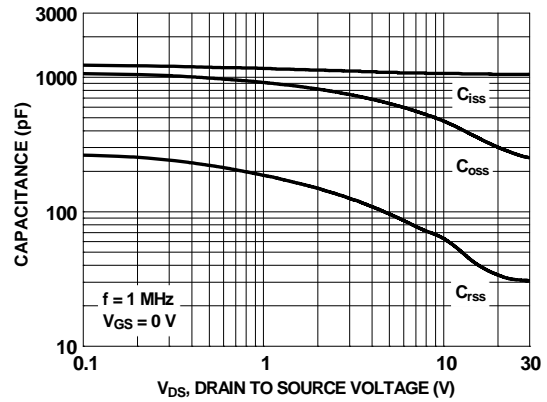
Figure 18. Source to Drain Diode Forward Voltage vs Source Current



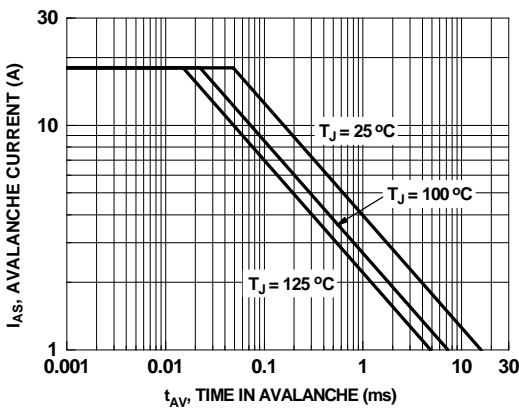
**Typical Characteristics (Q2 N-Channel)**  $T_J = 25^\circ\text{C}$  unless otherwise noted



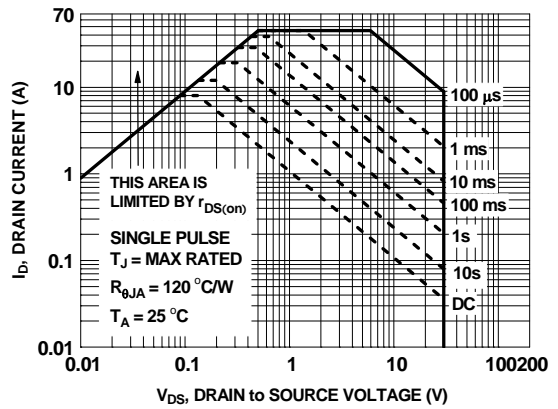
**Figure 19. Gate Charge Characteristics**



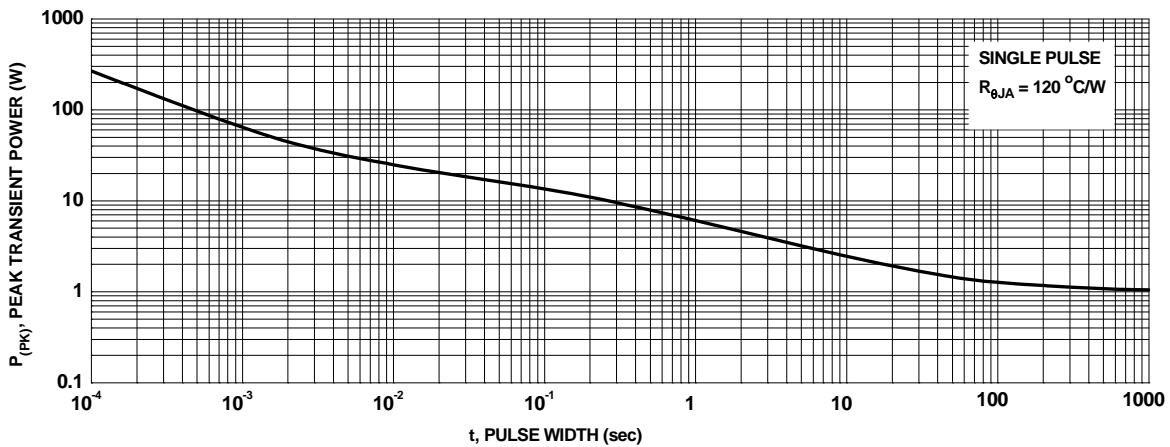
**Figure 20. Capacitance vs Drain to Source Voltage**



**Figure 21. Unclamped Inductive Switching Capability**

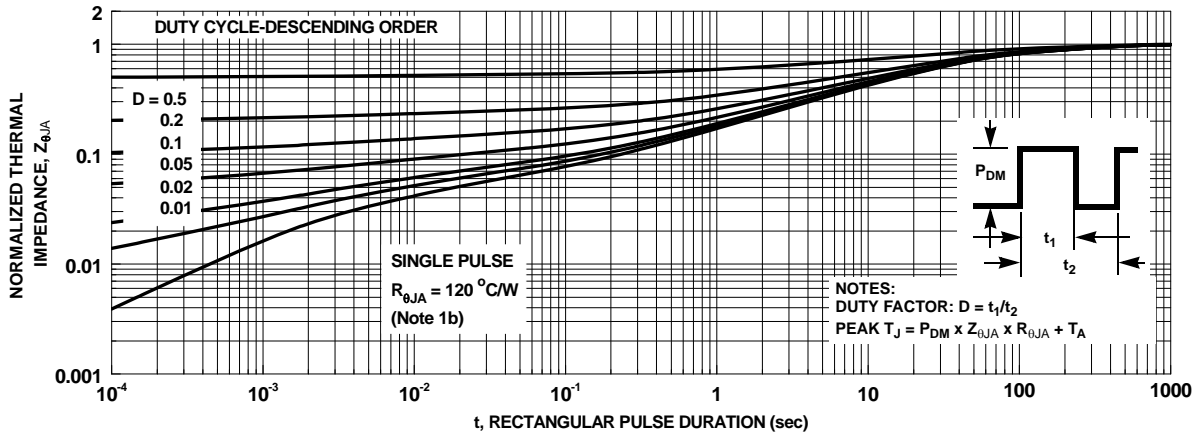


**Figure 22. Forward Bias Safe Operating Area**



**Figure 23. Single Pulse Maximum Power Dissipation**

**Typical Characteristics (Q2 N-Channel)  $T_J = 25\text{ }^\circ\text{C}$  unless otherwise noted**



**Figure 24. Junction-to-Ambient Transient Thermal Response Curve**

## Typical Characteristics (continued)

### SyncFET<sup>™</sup> Schottky body diode Characteristics

Fairchild's SyncFET<sup>™</sup> process embeds a Schottky diode in parallel with PowerTrench<sup>®</sup> MOSFET. This diode exhibits similar characteristics to a discrete external Schottky diode in parallel with a MOSFET. Figure 26 shows the reverse recovery characteristic of the FDMS7620S.

Schottky barrier diodes exhibit significant leakage at high temperature and high reverse voltage. This will increase the power in the device.

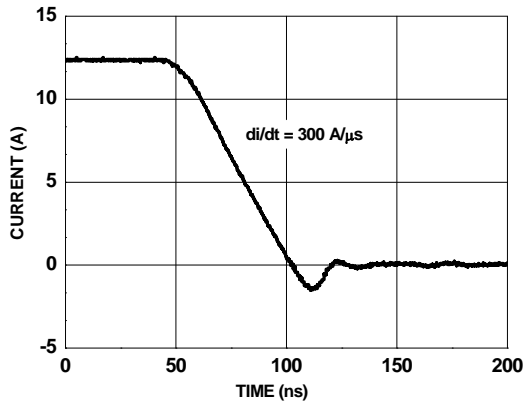


Figure 25. FDMS7620S SyncFET<sup>™</sup> Body Diode Reverse Recovery Characteristic

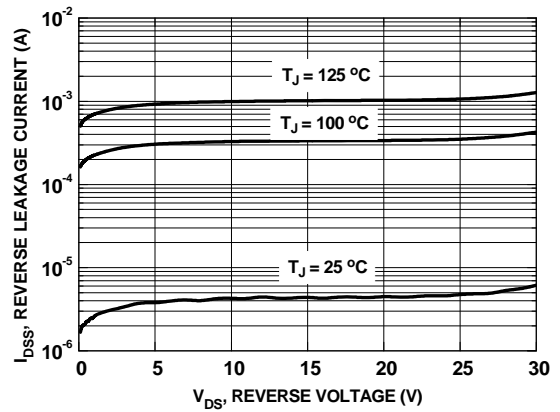
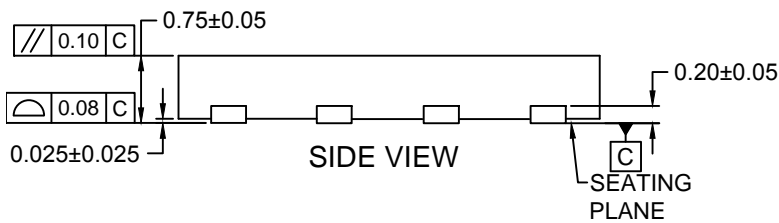
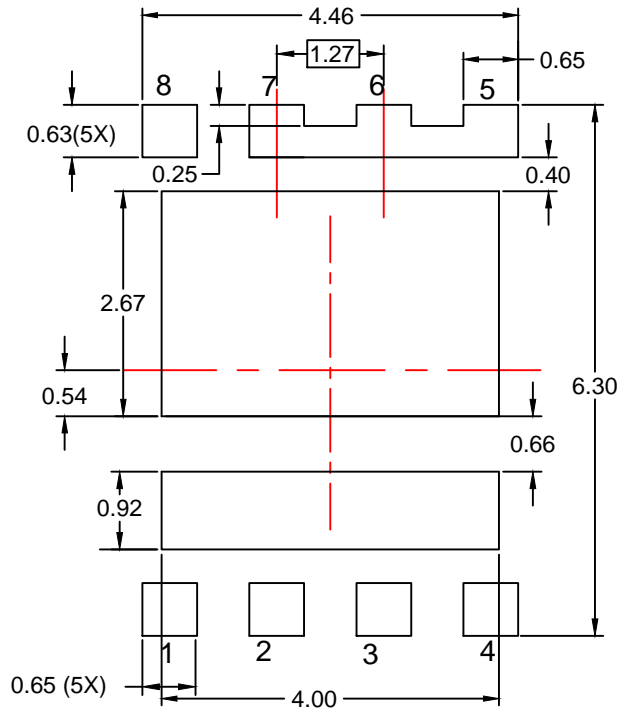
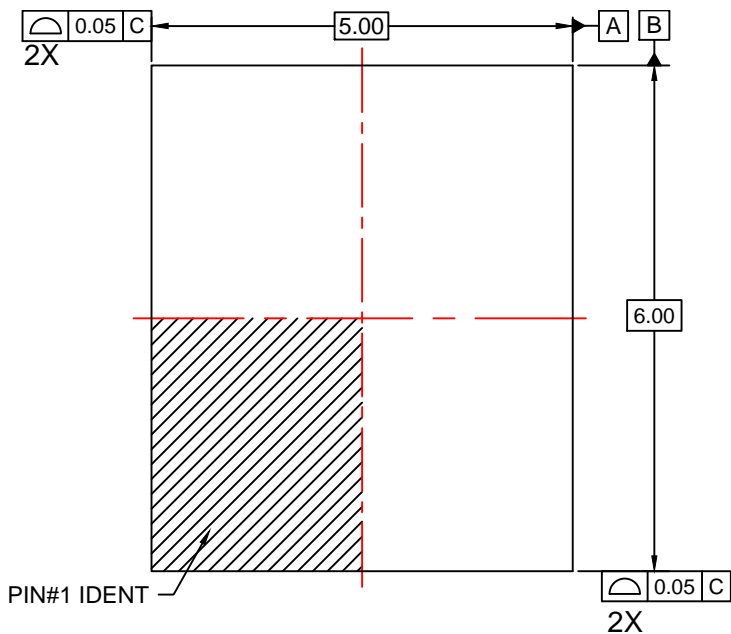
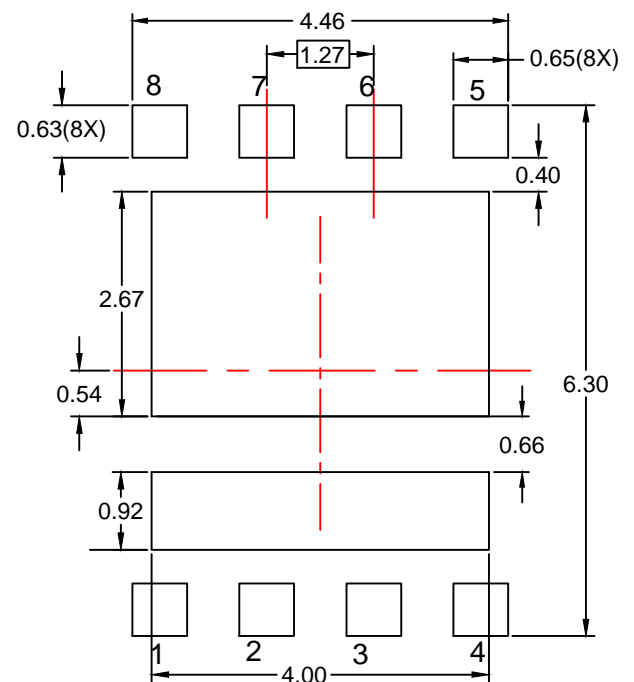
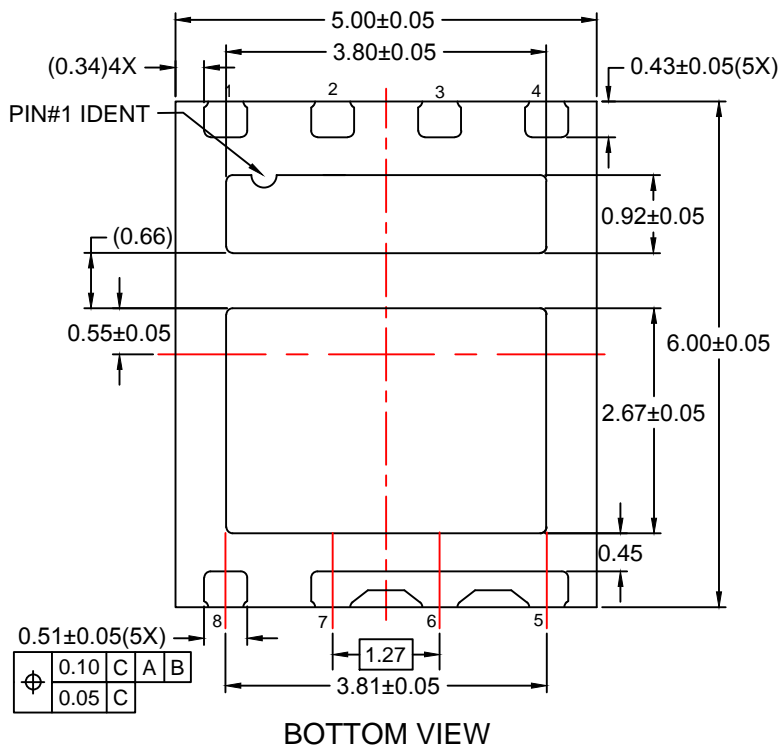


Figure 26. SyncFET<sup>™</sup> Body Diode Reverse Leakage vs. Drain-Source Voltage



RECOMMENDED LAND PATTERN (OPTION 1 - FUSED LEADS 5,6,7)



RECOMMENDED LAND PATTERN (OPTION 2 - ISOLATED LEADS)

**NOTES:**

- A. PACKAGE DOES NOT FULLY CONFORM TO JEDEC STANDARD.
- B. DIMENSIONS ARE IN MILLIMETERS.
- C. DIMENSIONS AND TOLERANCES PER ASME Y14.5M, 2009.
- D. LAND PATTERN RECOMMENDATION IS EXISTING INDUSTRY LAND PATTERN.
- E. DRAWING FILENAME: MKT-MLP08Prev2.



ON Semiconductor and  are trademarks of Semiconductor Components Industries, LLC dba ON Semiconductor or its subsidiaries in the United States and/or other countries. ON Semiconductor owns the rights to a number of patents, trademarks, copyrights, trade secrets, and other intellectual property. A listing of ON Semiconductor's product/patent coverage may be accessed at [www.onsemi.com/site/pdf/Patent-Marking.pdf](http://www.onsemi.com/site/pdf/Patent-Marking.pdf). ON Semiconductor reserves the right to make changes without further notice to any products herein. ON Semiconductor makes no warranty, representation or guarantee regarding the suitability of its products for any particular purpose, nor does ON Semiconductor assume any liability arising out of the application or use of any product or circuit, and specifically disclaims any and all liability, including without limitation special, consequential or incidental damages. Buyer is responsible for its products and applications using ON Semiconductor products, including compliance with all laws, regulations and safety requirements or standards, regardless of any support or applications information provided by ON Semiconductor. "Typical" parameters which may be provided in ON Semiconductor data sheets and/or specifications can and do vary in different applications and actual performance may vary over time. All operating parameters, including "Typicals" must be validated for each customer application by customer's technical experts. ON Semiconductor does not convey any license under its patent rights nor the rights of others. ON Semiconductor products are not designed, intended, or authorized for use as a critical component in life support systems or any FDA Class 3 medical devices or medical devices with a same or similar classification in a foreign jurisdiction or any devices intended for implantation in the human body. Should Buyer purchase or use ON Semiconductor products for any such unintended or unauthorized application, Buyer shall indemnify and hold ON Semiconductor and its officers, employees, subsidiaries, affiliates, and distributors harmless against all claims, costs, damages, and expenses, and reasonable attorney fees arising out of, directly or indirectly, any claim of personal injury or death associated with such unintended or unauthorized use, even if such claim alleges that ON Semiconductor was negligent regarding the design or manufacture of the part. ON Semiconductor is an Equal Opportunity/Affirmative Action Employer. This literature is subject to all applicable copyright laws and is not for resale in any manner.

## PUBLICATION ORDERING INFORMATION

### LITERATURE FULFILLMENT:

Literature Distribution Center for ON Semiconductor  
19521 E. 32nd Pkwy, Aurora, Colorado 80011 USA  
**Phone:** 303-675-2175 or 800-344-3860 Toll Free USA/Canada  
**Fax:** 303-675-2176 or 800-344-3867 Toll Free USA/Canada  
**Email:** [orderlit@onsemi.com](mailto:orderlit@onsemi.com)

**N. American Technical Support:** 800-282-9855 Toll Free  
USA/Canada  
**Europe, Middle East and Africa Technical Support:**  
Phone: 421 33 790 2910  
**Japan Customer Focus Center**  
Phone: 81-3-5817-1050

**ON Semiconductor Website:** [www.onsemi.com](http://www.onsemi.com)  
**Order Literature:** <http://www.onsemi.com/orderlit>  
For additional information, please contact your local  
Sales Representative