

Oct.1.2018 Copyright 2018 HIROSE ELECTRIC CO., LTD. All Rights Reserved.  
 In case that the application demands a high level of reliability, such as automotive,  
 please contact a company representative for further information.

△ ELV, RoHS COMPLIANT

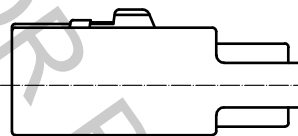
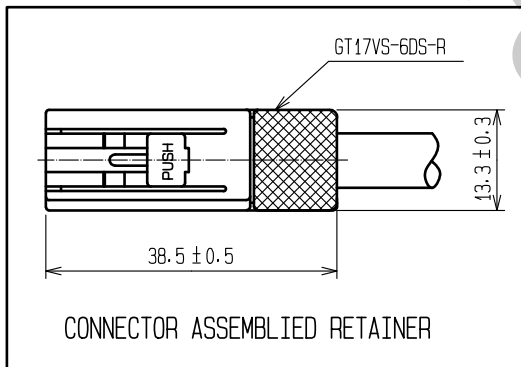
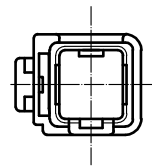
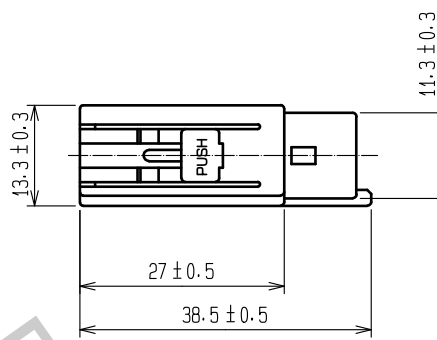
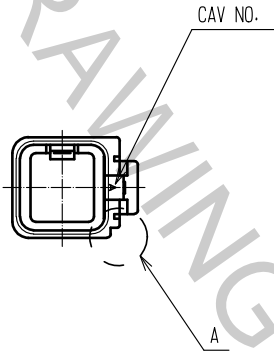
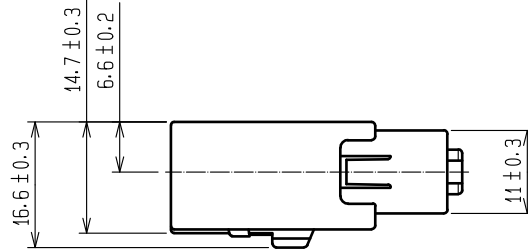
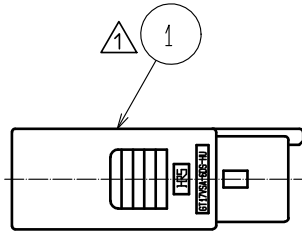
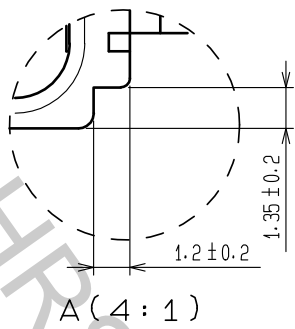

NOTE1. THIS CONNECTOR SHALL BE USED THAT RETAINER (CL767-0053-2) WAS ASSEMBLED.  
 2. APPLICABLE CABLE DIA :  $\phi$  4.8 TO  $\phi$  5.2

1	PBT	△ BLACK						
NO.	MATERIAL	FINISH	REMARKS	NO.	MATERIAL	FINISH	REMARKS	
UNITS mm		SCALE 1 : 1	COUNT △ 3	DESCRIPTION OF REVISIONS DIS-T-00000765		DESIGNED MH. SHOUJI	CHECKED KI. HIROKAWA	DATE 15.12.16
HIROSE ELECTRIC CO., LTD.		APPROVED : KS. SATOH	05.01.05	DRAWING NO.		EDC4-165623-00		
		CHECKED : NH. NAKATA	05.01.05	PART NO.		GT17VSA-6DS-HU		
		DESIGNED : NA. HARUBAYASHI	05.01.05	CODE NO.		CL767-0052-0-00		
		DRAWN : TK. SHISHIKURA	05.01.05			△ 1/1		