

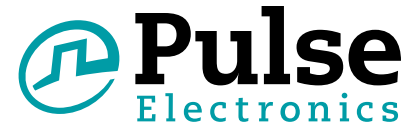



Automotive Chip Choke[®]

EMI Suppression for CAN-Bus Networks

2-Line Common Mode Chokes



-  Meets AEC-Q200 Requirements
-  Suppression of common mode noise without attenuating the signal
-  Magnetically shielded versions for lower Rdc and higher current
-  USB 3.0 and other high speed differential signal lines (IEEE1394, LVDS)

Electrical Specifications @ 25°C - Operating Temperature -40°C to +125°C

Part Number	Common Mode Impedance (10MHZ)		Inductance (uH)	Standard Tolerance	RDC (Ω Max)	IDC (A MAX)
	Min	Typ				
PE-1812ACC110STS	300	600	11	+50/-30%	0.5	0.36
PE-1812ACC220STS	600	1200	22	+50/-30%	0.6	0.31
PE-1812ACC510STS	1500	3500	51	+50/-30%	1.0	0.23
PE-1812ACC101STS	3000	7500	100	+50/-30%	2.0	0.20

Weight120 grams/reel

Tape & Reel150/reel

Mechanical

Schematic

PE-1812ACCXXSTS

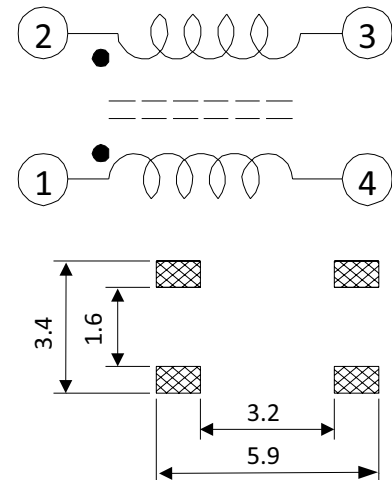
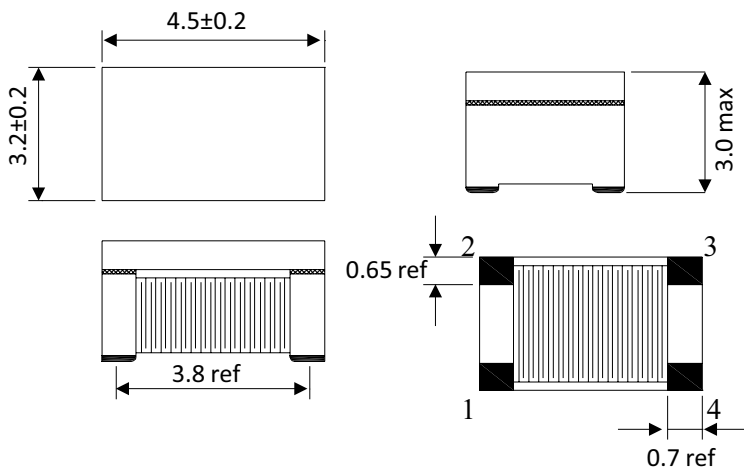

USA 858 674 8100

Germany 49 7032 7806 0

Singapore 65 6287 8998

Shanghai 86 21 62787060

China 86 755 33966678

Taiwan 886 3 4356768

Automotive Chip Choke®

EMI Suppression for CAN-Bus Networks

2-Line Common Mode Chokes



Impedance vs Frequency

Temp vs DC Current

PE-1812ACC110STS

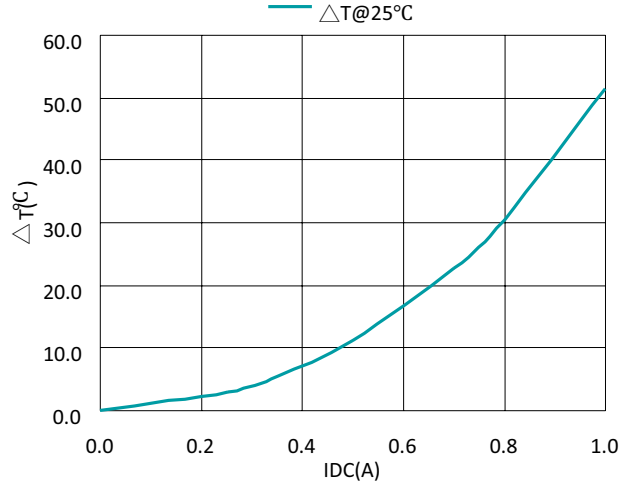
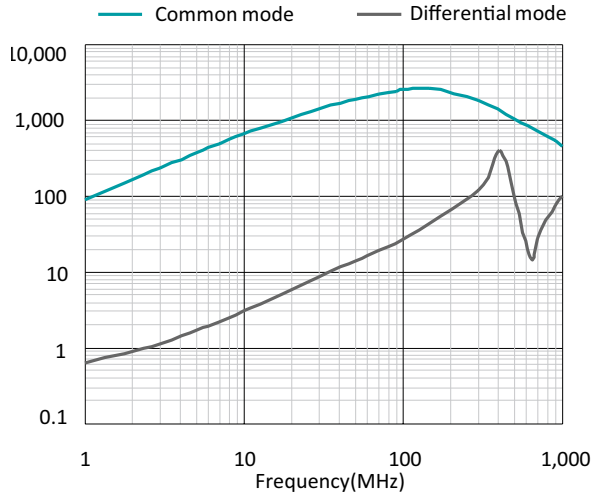

PE-1812ACC220STS

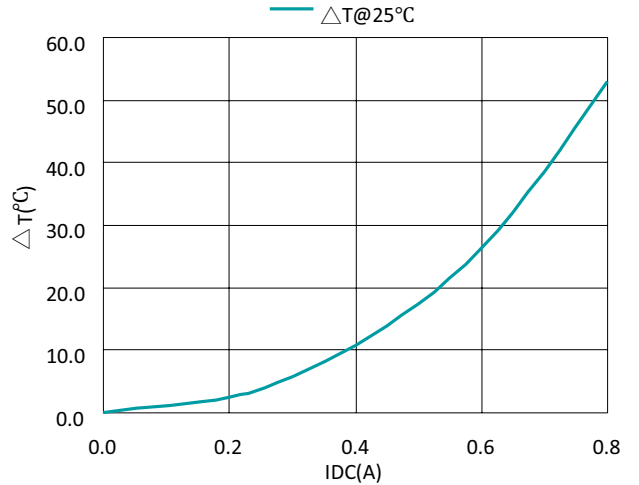
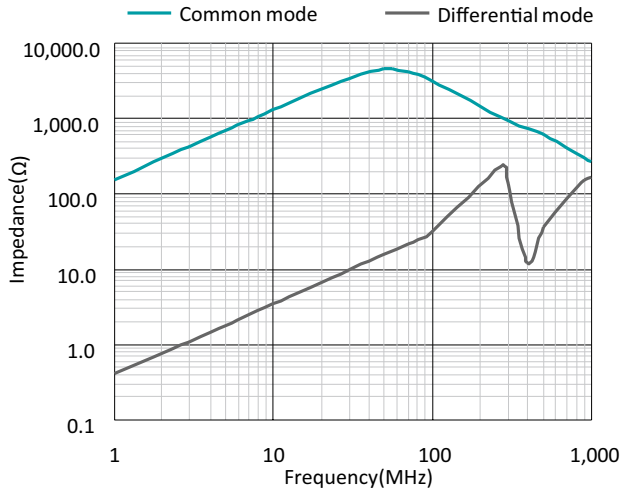

Automotive Chip Choke[®]

EMI Suppression for CAN-Bus Networks

2-Line Common Mode Chokes

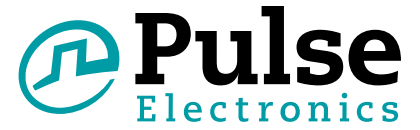

Impedance vs Frequency

Temp vs DC Current

PE-1812ACC510STS

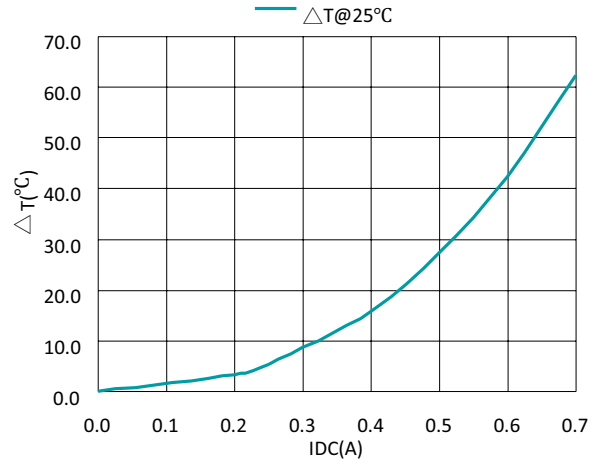
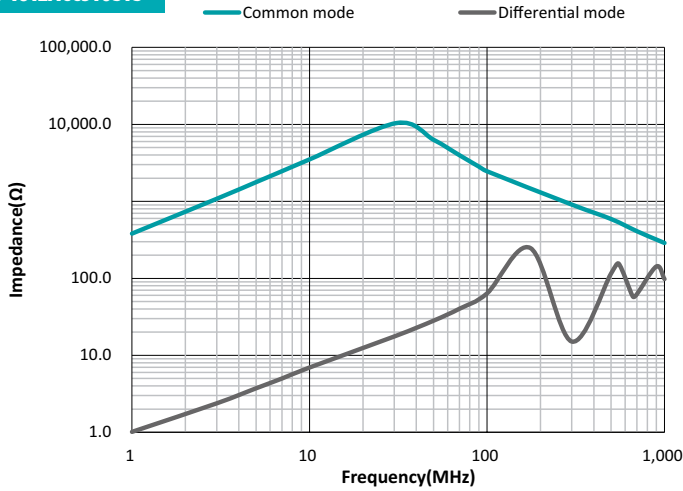

PE-1812ACC101STS

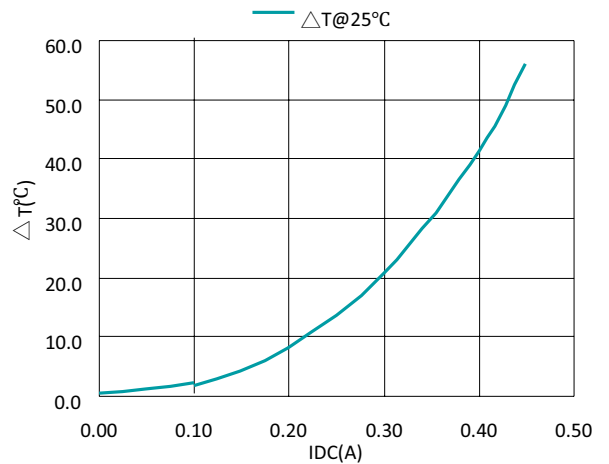
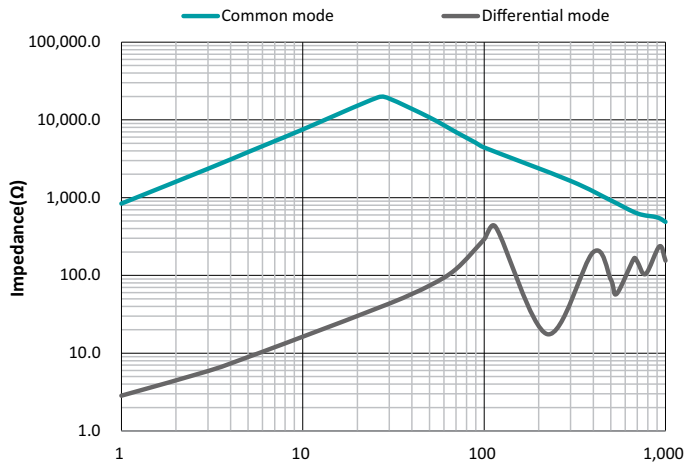

Automotive Chip Choke®

EMI Suppression for CAN-Bus Networks

2-Line Common Mode Chokes

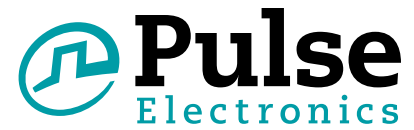

Reliability Test

Item	Reference documents	Test Condition	Test Specification
1. High Temperature Exposure	MIL-STD-202 Method 108	1. Temperature: 125°C 2. Time: 96 hours	1. No mechanical and electrical damage 2. Inductance shall not change more than $\pm 30\%$
2. Temperature Cycling	JESD22 Method JA-104	1. Temperature: 40°C-125°C 2. Number of cycles: 96 cycle 3. Dwell time: 30 minutes	1. No mechanical and electrical damage 2. Inductance shall not change more than $\pm 30\%$
3. Biased Humidity Test	MIL-STD-202 Method 103	1. Temperature: 85 \pm 5°C 2. Time: 96 hours 3. Humidity: 85 \pm 5% RH	1. No mechanical and electrical damage 2. Inductance shall not change more than $\pm 30\%$
4. Operational Life	MIL-PRF-27	1. Temperature: 125°C 2. Time: 96 hours 3. Apply rated current	1. No mechanical and electrical damage 2. Inductance shall not change more than $\pm 30\%$
5. External Visual	MIL-STD-883 Method 2009	Inspect product construction, marking and workmanship	Per product specification standard
6. Physical Dimensions	JESD22 Method JB-100	Verify physical dimensions to the applicable product detail specification	Per product specification standard
7. Resistance to solvents	MIL-STD-202 Method 215	Immerse into solvent for 3 \pm 0.5 minutes & brush 10 times for their cycles.	1. No body change in appearance 2. No marking blurred. 3. Inductance shall not change more than $\pm 30\%$
8. Vibration Test	MIL-STD-202 Method 204	1. Frequency and Amplified: 10-2000-10 Hz, 1.5mm 2. Direction: X, Y, Z 3. Test duration: 2 hours for each direction, 6 hours in total	1. No mechanical and electrical damage 2. Inductance shall not change more than $\pm 30\%$
9. Resistance to Soldering Heat Test	MIL-STD-202 Method 210	1. Temperature: 250 \pm 5°C 2. Time: (temp. \geq 217°C) 60-150 Second 3. IR reflow times: 3 times	1. No mechanical and electrical damage 2. Inductance shall not change more than $\pm 30\%$
10. Rated Current	MIL-STD-202 Method 330	Apply rated current for 5 seconds.	1. No mechanical and electrical damage 2. Inductance shall not change more than $\pm 30\%$
11. Temperature Rise	MIL-PRF-27	Apply rated current for 10 minutes.	1. No mechanical and electrical damage 2. Inductance shall not change more than $\pm 30\%$
12. Over load	MIL-PRF-27	Apply twice as rated current for 5 minutes.	1. No mechanical and electrical damage 2. Inductance shall not change more than $\pm 30\%$
13. Solderability Test	J-STD-002	1. Baking in pre-testing: 155 \pm 5°C / 16Hours \pm 30min. 2. Peak temperature: 240 \pm 5°C 3. Time: (temp. \geq 217°C) 60-150 Second 4. IR reflow times: 1 time	The terminal shall be at least 95% covered with fresh solder.
14. Electrical Characterization	User Spec.	1. Operating temperature: -40°C-125°C 2. Room Temperature: 25°C	1. No mechanical and electrical damage 2. Inductance shall not change more than $\pm 30\%$
15. Withstanding Voltage Test	MIL-STD-202 Method 201	1. DV: 500V 2. Time: 1 minute	1. During the test no breakdown. 2. The characteristic is normal after test.
16. Drop	JESD22-B111	Package & Drop down from 1m. In 1 angle 1 ridge & 2 surfaces orientation	1. No case deformation or change in appearance. 2. Inductance shall not change more than $\pm 30\%$
17. Terminal Strength Test	JIS-C-6429	1. Apply push force to samples mounted on PCB. 2. Force of 1.8 kg for 60 \pm 1 seconds.	After test, inductors shall be on mechanical damage.

Automotive Chip Choke®

EMI Suppression for CAN-Bus Networks

2-Line Common Mode Chokes

Tape and Reel Specifications

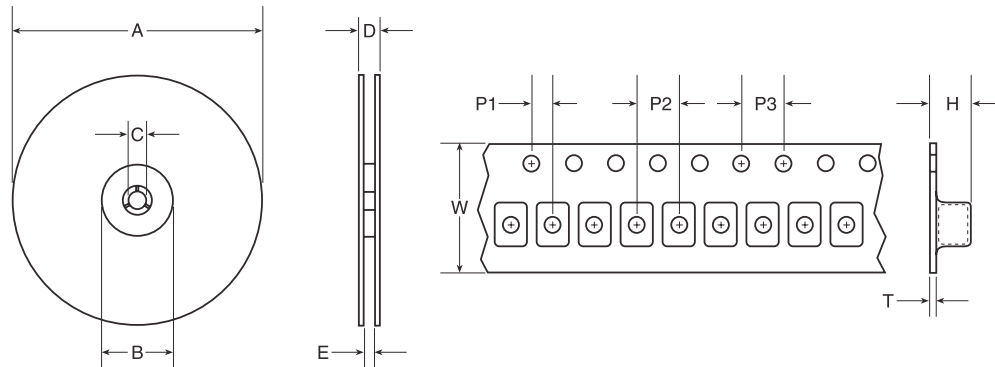

Series	Parts per Reel	Reel Dimensions (mm)					Tape Dimensions (mm)					
		A	B	C	D	E	W	P1	P2	P3	H	T
1812 ACC	500	178	60	13	17	14	12	2	8	4	4	0.35

III. Description:

- Ferrite drum core construction
- Magnetically shielded
- Enameled copper wire: H class
- Product weight: 0.15g (ref.)
- Moisture sensitivity Level 1
- Products comply with RoHS' requirements
- Halogen Free available

IV. General specification:

- Storage temp: -40°C to +125°C
- Operating temp: -40°C to +125°C
(Temp. rise included)
- Resistance to solder heat: 250°C 10 secs.

Recommended Solder Heat Resistance Profile

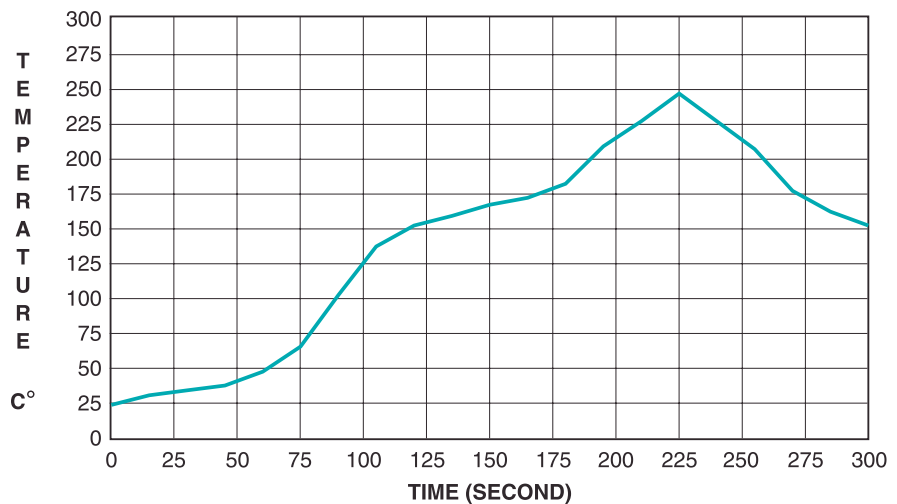

For More Information

Pulse Worldwide Headquarters
12220 World Trade Drive
San Diego, CA
92128
U.S.A.

Tel: 858 674 8100
Fax: 858 674 8262

Pulse Europe
Einsteinstrasse 1
D-71083 Herrenberg
Germany

Tel: 49 7032 78060
Fax: 49 7032 7806 135

Pulse China Headquarters
B402, Shenzhen Academy of
Aerospace Technol-
ogy Bldg.
10th Kejinan Road
High-Tech Zone
Nanshan District
Shenzen, PR China
518057
Tel: 86 755 33966678
Fax: 86 755 33966700

Pulse North China
Room 2704/2705
Super Ocean Finance
Ctr.
2067 Yan An Road
West
Shanghai 200336
China
Tel: 86 21 62787060
Fax: 86 2162786973

Pulse South Asia
135 Joo Seng Road
#03-02
PM Industrial Bldg.
Singapore 368363
Tel: 65 6287 8998
Fax: 65 6287 8998

Pulse North Asia
3F, No. 198
Zhongyuan Road
Zhongli City
Taoyuan County 320
Taiwan R. O. C.
Tel: 886 3 4356768
Fax: 886 3 4356823 (Pulse)
Fax: 886 3 4356820 (FRE)

Performance warranty of products offered on this data sheet is limited to the parameters specified. Data is subject to change without notice. Other brand and product names mentioned herein may be trademarks or registered trademarks of their respective owners. © Copyright, 2015, Pulse Electronics, Inc. All rights reserved.