

Model No: FSL-0818R01-08

Rev: 1

Product Line: Tymphany

Last Update: 2017-04-21 12:39:42

## Product Description

This 8 inch 8 ohm speaker features a FEA optimized ferrite magnet motor, a 1.8 inch high-temperature voice coil, vented yoke for motor colling, and a high strength stamped steel frame. Kevlar loaded non-pressed paper cone to help dampen and control cone resonance. The multi-roll surround and spider have been optimized to reduce distortion over the excursion range of this transducer.



## Mechanical Drawing

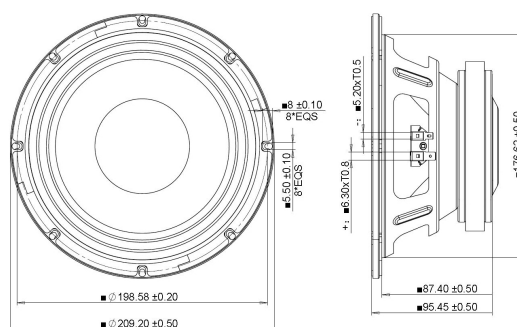

## Specifications

DC Resistance	Revc	Ohms	5.56	5.0%	Energy Bandwidth Product	EBP	(1/Qes)*fs
Minimum Impedance	Zmin	Ohms	7.32	7.5%	Moving Mass	Mms	g
Voice Coil Inductance	Le	mH	0.48		Suspension Compliance	Cms	um/N
Resonant Frequency	Fs	Hz	73.93	15%	Effective Cone diameter	D	cm
Mechanical Q Factor	Qms		3.03		Effective Piston Area	Sd	cm <sup>2</sup>
Electrical Q Factor	Qes		0.4		Effective Volume	Vas	L
Total Q Factor	Qts		0.35		Motor Force Factor	BL	Tm
Ratio Fs/Qts	F	Fs/Qts	210.62		Motor Efficiency Factor	$\beta$	(T*M <sup>2</sup> )/Ohms
Half Space Sensitivity @2.83V	db@2.83V/1M	dB	94.82	+/- 1.0db	Voice coil former Material	VCfm	KSV
Half Space Sensitivity @1W/1M	db@1W/1M	dB	94.4	+/- 1.0db	Voice coil inner diameter	VCd	mm
Gap Height	Gh	mm	6		Rated Noise Power	P	W
Maximum Linear Excursion	Xmax	mm	2.2		Test Spectrum Bandwidth		70Hz-700Hz
Ferrofluid Type	FF				Driver Size	Inch	8 in
Driver Mass	Kg		2.4				

## Frequency and Impedance Response

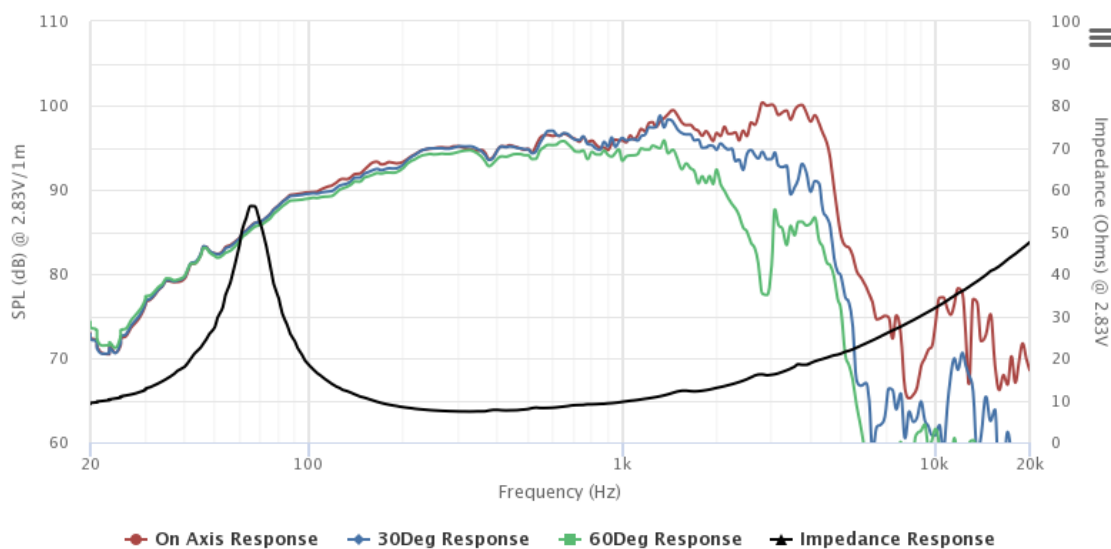

Highcharts.com