

ISL85413EVAL1Z, ISL85412EVAL1Z Evaluation Boards

Description

The ISL85413EVAL1Z, ISL85412EVAL1Z kits are intended for use in point-of-load applications sourcing from 3.5V to 40V. The kits are used to demonstrate the performance of the ISL85413, ISL85412 Wide V_{IN} Low Quiescent Current High Efficiency Synchronous Buck Regulator with 300mA or 150mA output current.

The ISL85413, ISL85412 are offered in a 3mmx3mm 8 Ld DFN package with 1mm maximum height.

Specifications

The evaluation boards are designed to operate at the following operating conditions:

- Input voltage rating from 3.5V to 40V
- Fixed 3.3V output voltage
- Up to 300mA output current (ISL85413), up to 150mA output current (ISL85412)
- 700kHz switching frequency
- Operating junction temperature range: -40°C to +125°C

Key Features

- Small, compact design
- Switch selectable EN (enable/disabled)
- Switch selectable MODE (auto PFM/forced PWM)
- Connectors, test points and jumpers for easy probing

References

- Reference [ISL85413](#) and [ISL85412](#) datasheets for efficiency and typical performance curves

Ordering Information

PART NUMBER	DESCRIPTION
ISL85413EVAL1Z	Evaluation Board (300mA Output Current)
ISL85412EVAL1Z	Evaluation Board (150mA Output Current)



FIGURE 1. FRONT OF EVALUATION BOARD ISL85413EVAL1Z



FIGURE 2. BACK OF EVALUATION BOARD ISL85413EVAL1Z

Functional Description

The ISL85413EVAL1Z, ISL85412EVAL1Z provide simple platforms to demonstrate the features of the ISL85413, ISL85412 wide input synchronous buck regulator. The ISL85413EVAL1Z is for 300mA output current and ISL85412EVAL1Z is for 150mA output current. The evaluation boards have been functionally optimized for best performance of the ISL85413, ISL85412 ICs.

The ISL85413EVAL1Z board is shown in [Figures 1](#) and [2](#). The evaluation board contains an S1 switch that enables or disables the part, thus allowing low quiescent current state. The MODE function is controlled by a S2 switch that allows different mode operation. Default board configuration has $R_6 = 200k$ to V_{CC} , which defaults to PWM operation mode. If this pin is tied to GND, the IC will operate in PFM mode.

The schematic of the ISL85413EVAL1Z evaluation board is shown on [page 3](#). The PCB layout images for top and bottom layers are shown in [Figures 3](#) and [4](#). The Bill of Materials of the ISL85413EVAL1Z and ISL85412EVAL1Z is shown on [page 3](#).

Operating Range

The V_{IN} range of the boards is 3.5V to 40V. The V_{OUT} range is 0.6V to 12V. The operating junction temperature range is -40°C to $+125^{\circ}\text{C}$.

Recommended Equipment

The following materials are recommended to perform testing:

- 0V to 50V power supply with at least 2A source current capability
- Electronic loads capable of sinking current up to 1.5A
- Digital Multimeters (DMMs)
- 100MHz quad-trace oscilloscope
- Signal generator

TABLE 1. EXTERNAL COMPONENT SELECTION (REFER TO [Figure 1](#))

V_{OUT} (V)	C_4 (pF)	C_8 (μF)	L_1 (μH)	R_1 (k Ω)	R_2 (k Ω)
1.0	100	2x22	10	90.9	137
1.2	100	2x22	10	90.9	90.9
1.5	100	2x22	16	90.9	60.4
1.8	100	2x22	16	90.9	45.3
2.5	100	22	22	90.9	28.7
3.3	100	22	33	90.9	20.0
5.0	100	22	47	90.9	12.4
12	100	22	100	90.9	4.75

Quick Setup Guide

1. Ensure that the circuit is correctly connected to the supply and loads prior to applying any power.
2. Connect the bias supply to VIN, the plus terminal to VIN and the negative return to GND1.
3. Verify that the position is ON for S1.
4. Turn on the power supply.
5. Verify the output voltage is 3.3V for V_{OUT} .

Evaluating the Other Output Voltage

The ISL85413VAL1Z and ISL85412VAL1Z kit outputs are preset to 3.3V; however, output voltages can be adjusted from 0.6V to 12V. The output voltage programming resistor, R_2 , will depend on the desired output voltage of the regulator. The value for the feedback resistor is typically between 0Ω and $50k\Omega$ as shown in [Equation 1](#).

$$R_2 = R_1 \left(\frac{0.6}{V_{OUT} - 0.6} \right) \quad (\text{EQ. 1})$$

If the output voltage desired is 0.6V, then R_1 is shorted.

[Table 1](#) shows the component selection that should be used for the respective V_{OUT} .

ISL85413EVAL1Z Schematic

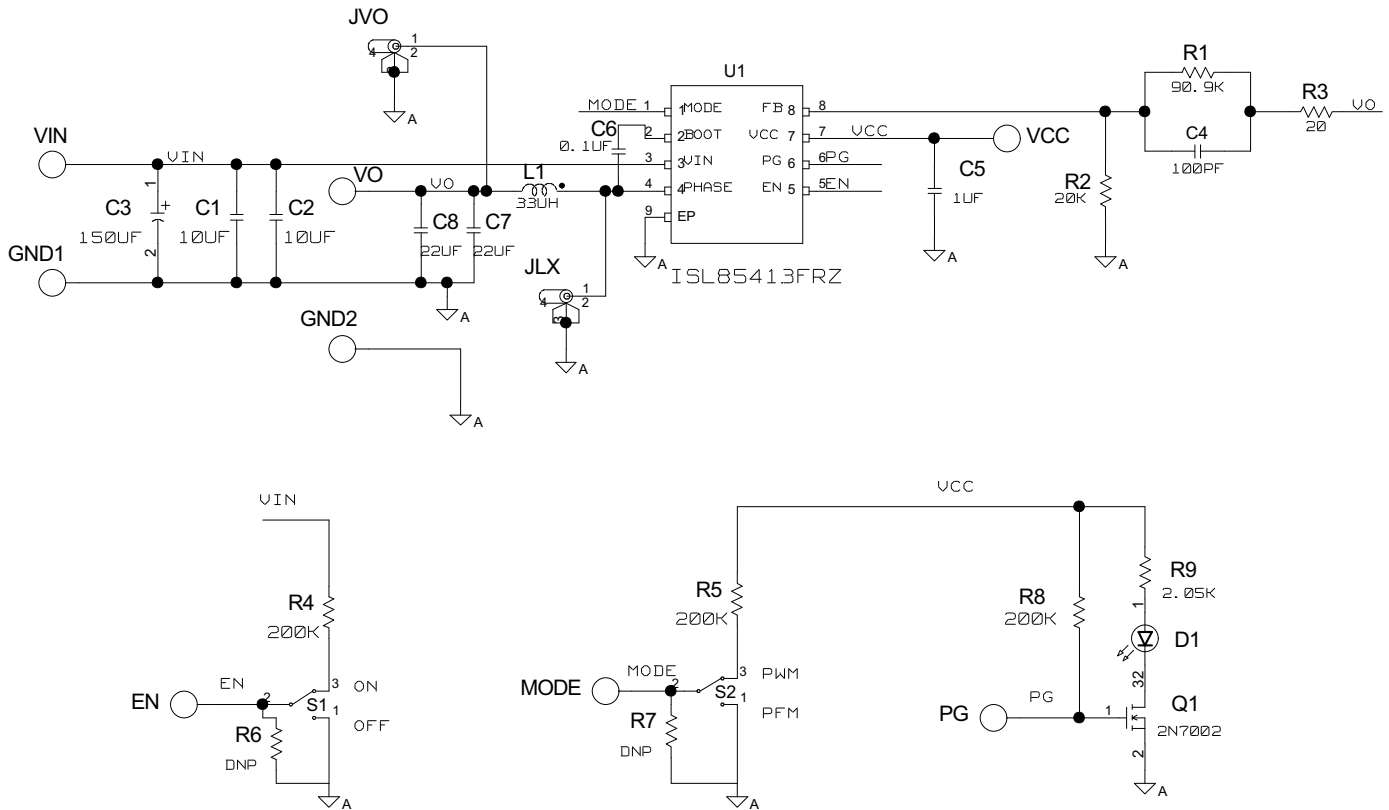

ISL85413EVAL1Z, ISL85412EVAL1Z Bill of Materials

MANUFACTURER PART	QTY	UNITS	REFERENCE DESIGNATOR	DESCRIPTION	MANUFACTURER
ISL85413EVAL1ZREVAPCB	1	ea	SEE LABEL- RENAME BOARD	PWB-PCB, ISL85413EVAL1Z, REVA, ROHS	TBD
C1608X7R1C105K	1	ea	C5	CAP, SMD, 0603, 1.0µF, 16V, 10%, X7R, ROHS	TDK
EEE-FK1H151P	1	ea	C3	CAP, SMD, 10.3mm, 150µF, 50V, 20%, ROHS, ALUM.ELEC.	PANASONIC
06035C104KAT2A	1	ea	C6	CAP, SMD, 0603, 0.1µF, 50V, 10%, X7R, ROHS	AVX
ECJ-1VC1H331J	1	ea	C4	CAP, SMD, 0603, 100pF, 50V, 5%, NP0, ROHS	PANASONIC
C3216X5R1H106K	2	ea	C1, C2	CAP, SMD, 1206, 10µF, 50V, 10%, X5R, ROHS	TDK
GRM31CR60J226KE19L	1	ea	C7	CAP, SMD, 1206, 22µF, 6.3V, 10%, X5R, ROHS	MURATA
	0	ea	C8	CAP, SMD, 1206, DNP-PLACE HOLDER, ROHS	
DR73-330-R	1	ea	L1	COIL-PWR INDUCTOR, SMD, 7.6mm, 33µH, 20%, 1.31A, ROHS	COOPER/ COILTRONICS
131-4353-00	2	ea	JLX, JVO	CONN-SCOPE PROBE TEST PT, COMPACT, PCB MNT, ROHS	TEKTRONIX

Application Note 1929

ISL85413EVAL1Z, ISL85412EVAL1Z Bill of Materials (Continued)

MANUFACTURER PART	QTY	UNITS	REFERENCE DESIGNATOR	DESCRIPTION	MANUFACTURER
1514-2	4	ea	VO, VIN, GND1, GND2	CONN-TURRET, TERMINAL POST, TH, ROHS	KEYSTONE
5000	4	ea	EN, PG, VCC, SYNC	CONN-MINI TEST PT, VERTICAL, RED, ROHS	KEYSTONE
LTST-C190KGKT	1	ea	D1	LED, SMD, 0603, GREEN CLEAR, 2V, 20mA, 571nm, 35mcd, ROHS	LITEON/VISHAY
ISL85412FRZ for ISL85412EVAL1Z	1	ea	U1	IC-150mA BUCK REGULATOR, 12P, DFN, 3X3, ROHS	INTERSIL
ISL85413FRZ for ISL85413EVAL1Z	1	ea	U1	IC-300mA BUCK REGULATOR, 12P, DFN, 3X3, ROHS	INTERSIL
2N7002-7-F	1	ea	Q1	TRANSISTOR, N-CHANNEL, 3LD, SOT-23, 60V, 115mA, ROHS	DIODES, INC.
	0	ea	R6, R7	RESISTOR, SMD, 0603, 0.1%, MF, DNP-PLACE HOLDER	
ERJ-3EKF20R0V	1	ea	R3	RES, SMD, 0603, 20Ω, 1/10W, 1%, TF, ROHS	PANASONIC
CR0603-10W-2002FT	1	ea	R2	RES, SMD, 0603, 20k, 1/10W, 1%, TF, ROHS	VENKEL
CR0603-10W-2003FT	3	ea	R4, R5, R8	RES, SMD, 0603, 200k, 1/10W, 1%, TF, ROHS	VENKEL
CR0603-10W-2051FT	1	ea	R9	RES, SMD, 0603, 2.05k, 1/10W, 1%, TF, ROHS	VENKEL
ERJ-3EKF9102V	1	ea	R1	RES, SMD, 0603, 91k, 1/10W, 1%, TF, ROHS	PANASONIC
GT11MSCBE	2	ea	S1, S2	SWITCH-TOGGLE, SMD, 6PIN, SPDT, 2POS, ON-ON, ROHS	ITT INDUSTRIES/ C&K DIVISION

Intersil Corporation reserves the right to make changes in circuit design, software and/or specifications at any time without notice. Accordingly, the reader is cautioned to verify that the document is current before proceeding.

For information regarding Intersil Corporation and its products, see www.intersil.com

ISL85413EVAL1Z Board Layout

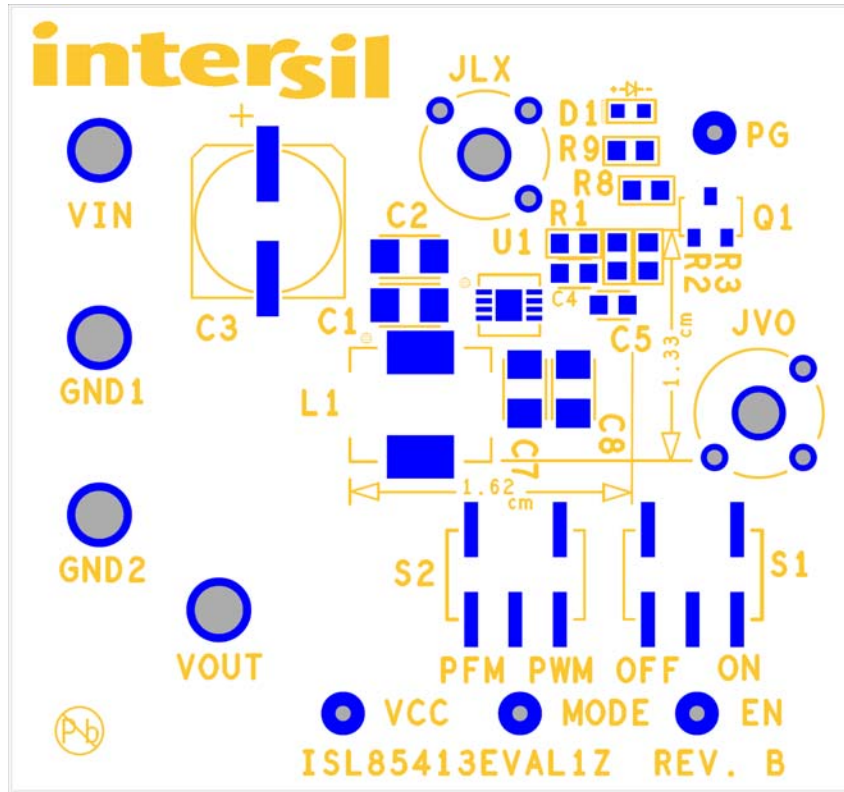

FIGURE 3. SILK SCREEN TOP

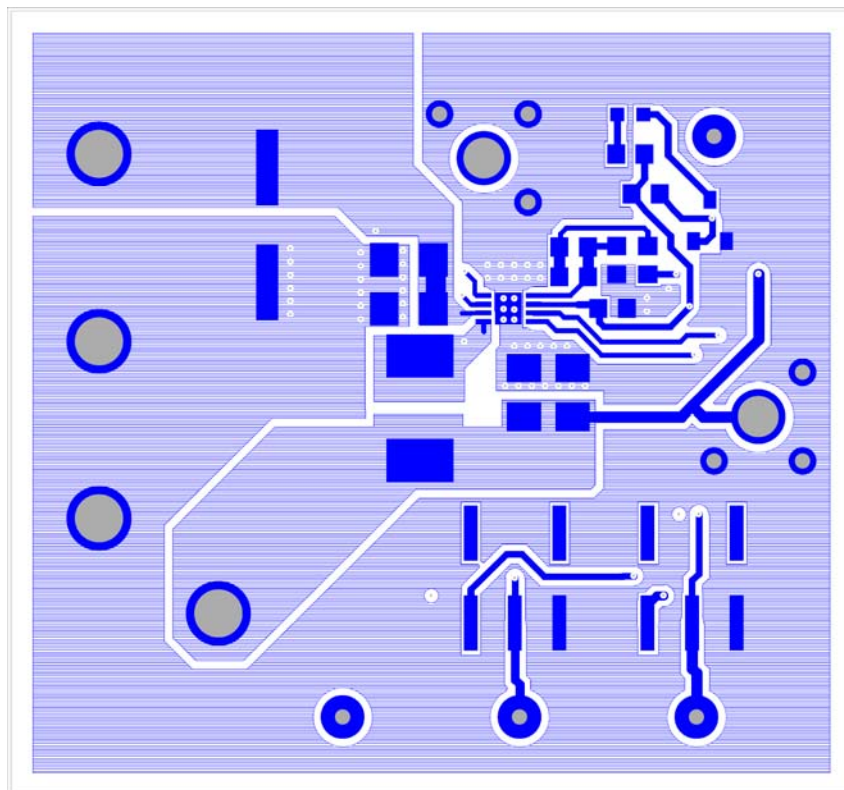

FIGURE 4. TOP LAYER COMPONENT SIDE

ISL85413EVAL1Z Board Layout (continued)

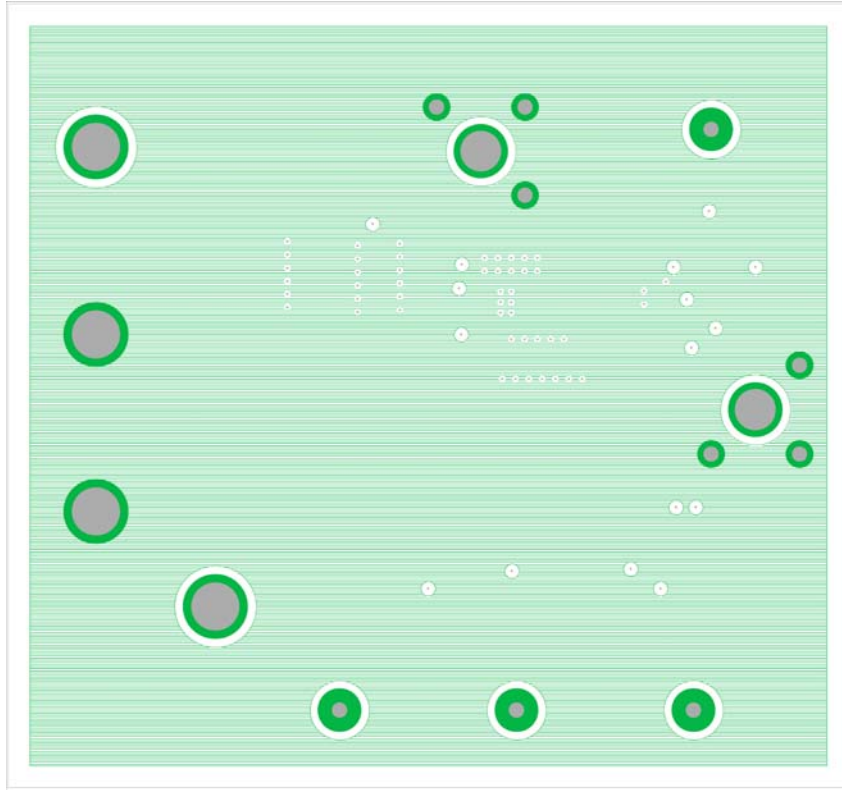

FIGURE 5. LAYER 2

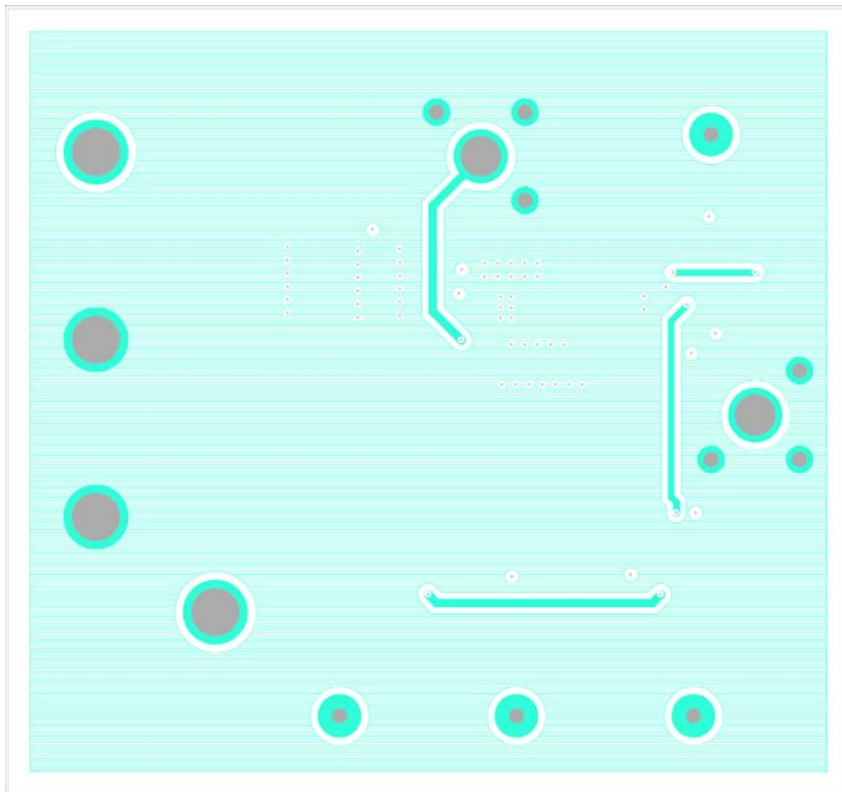

FIGURE 6. LAYER 3

ISL85413EVAL1Z Board Layout (continued)

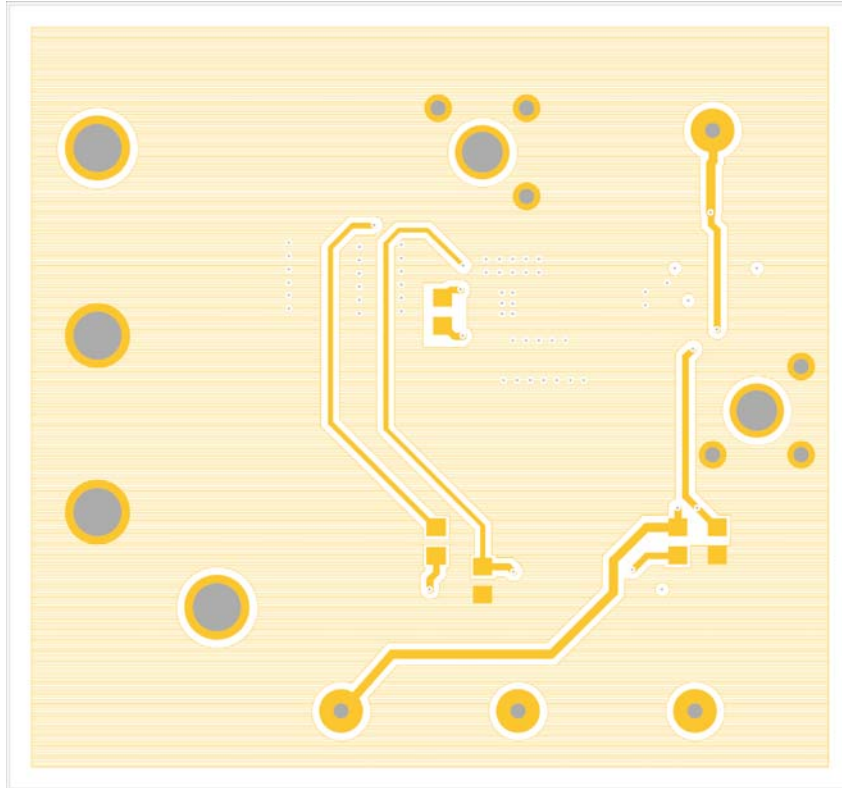

FIGURE 7. LAYER 4

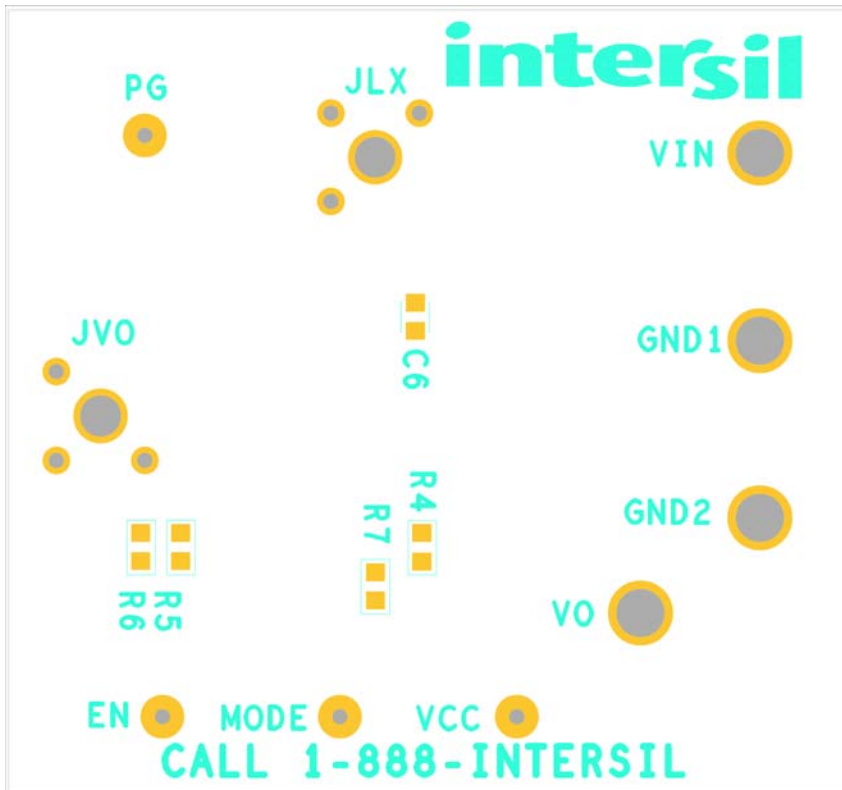

FIGURE 8. SILK SCREEN BOTTOM