



Memory Products

Serial EEPROM • Serial SRAM • NOR Flash



Memory Products

Microchip's Memory Products

Memory products are at the heart of electronic devices and systems we use every day. Virtually all consumer electronics, communication, computing, automotive and medical devices require certain types of memory to store software code, data and parameters. Microchip has been a leading supplier of memory products for over 25 years. Microchip's broad portfolio of memory products includes:

- Serial EEPROM
- Serial SRAM
- Serial Flash
- Parallel Flash

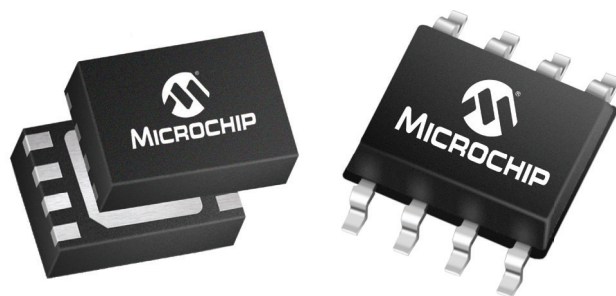

Microchip's Memory Portfolio

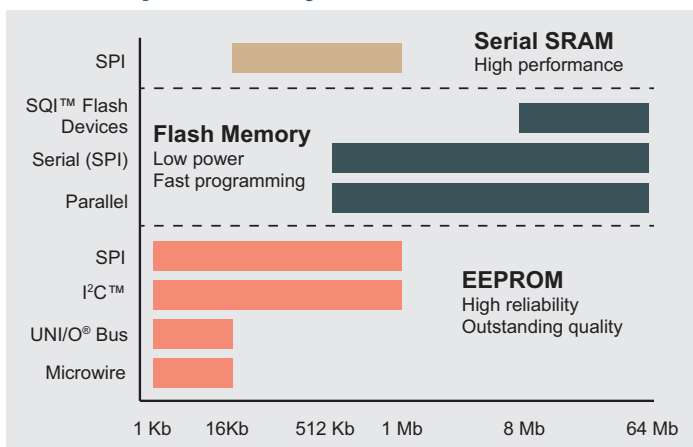

Quality Comes First

Microchip has been a leader in non-volatile memory products for over 25 years.

- “Quality Comes First” is at the top of the list of our Guiding Values, which provide the core principles that define our culture and the way we do business.
- As an ISO/TS-16949-certified supplier since 2003, Microchip's aggregate system uniquely supports our commitment to exceptional quality.
- Our EEPROM products are built in Microchip-owned Fabs.
- Our EEPROM products are also tested in house, which enables better planning and inventory management.
- Our “No Obsolescence Policy” allows us to have the industry's longest product lifecycles.
- Our lead times are among the shortest in the industry, providing fast and reliable supply to our customers.

Here to Help Throughout Your Product Lifecycle

Reliable Product

- Robust EEPROM technology
 - < 1 PPM fails
 - ~ Zero infant mortality
- SuperFlash® technology memory cell
 - Fastest erases
 - Longest retention
- Specialty memory products

Reliable Support

- Global technical support
- 1000+ design partners
- 80+ distributors
- Global training network

Reliable Supply

- > 99% on-time delivery
- Longest product lifecycles
- Over 25 years NVM experience
- Seamless internal and sub-contractor operations

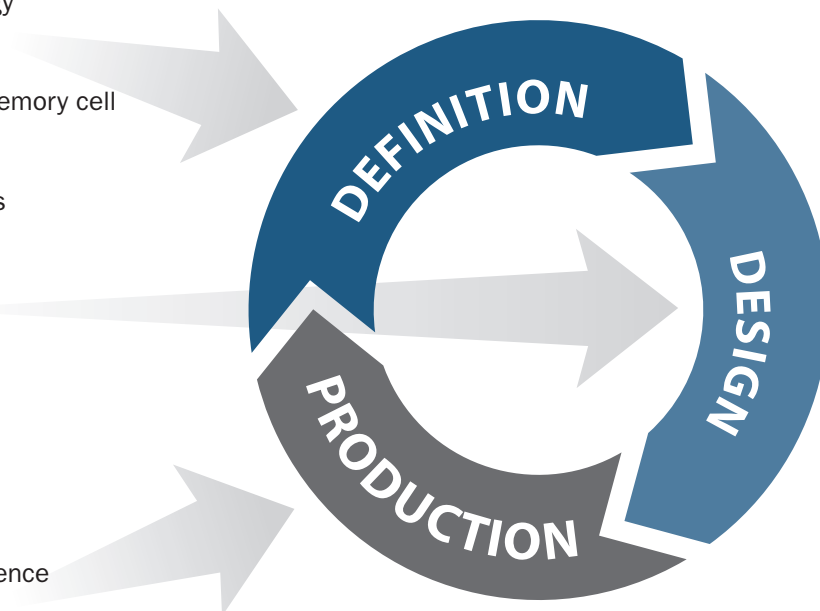

Serial EEPROM

Microchip offers the broadest range of Serial EEPROM devices. Our Serial EEPROMs are low-power, non-volatile memory devices with robust operating ranges, small-size and byte-alterability, making them ideal for data and program storage. Serial EEPROMs can be written more than 1 million times. Innovative low-power designs and extensive testing have ensured industry-leading endurance and best-in-class quality.

Key Features

- Broad range of densities: 128 bits to 1 Mbit
- Serial architecture: I²C™, SPI, UNI/O® bus, Microwire
- Tiny 3-, 5-, 6- and 8-pin packages; die and wafer
- Innovative, low-power designs
- Industry-leading endurance
- Wide temperature and voltage range
 - Operating voltage: 1.7 to 5.5 V
 - Temperature range: up to 150°C
- Fast read and write times
- Flexible
 - Byte-write capability
 - Multiple package options
 - Custom programming options
 - Application-specific serial memory
- ISO/TS16949-compliant

Robust Design

- ESD protection
 - > 4000V Human Body Model (HBM)
 - > 400V Machine Model (MM)
 - > 1000V charged device model
- Latch-up protection > 200 mA on all pins
- ESD-induced latch-up > 100 V (MM) on V_{DD}; > 400 V on all I/O; > 1 M cycles endurance and > 200 years data retention
- Up to 150°C operation (read and write)
- Power-On Reset (POR) and Brown-Out Reset (BOR)
 - Effective protection against noisy automotive environments
 - Eliminates false writes
- Schmitt Trigger input filters for noise reductions
- Complete traceability including die location on wafer



Industry-Leading Testing

Microchip's best-in-class field performance is the combined result of world-class manufacturing, wafer-level burn-in and wafer probe quality screens. Microchip's Triple-Test Flow is currently the most robust testing procedure for Serial EEPROM devices in the industry. It tests each cell of each die three times and performs extensive endurance and data retention tests to ensure quality and reliability. Infant mortality of Microchip Serial EEPROMs is among the lowest in the industry due to this extensive testing, excellent fabrication and highly-reliable memory cell design.

Triple-Test Flow

Microchip tests every cell in wafer form twice, then performs a final test after assembly.

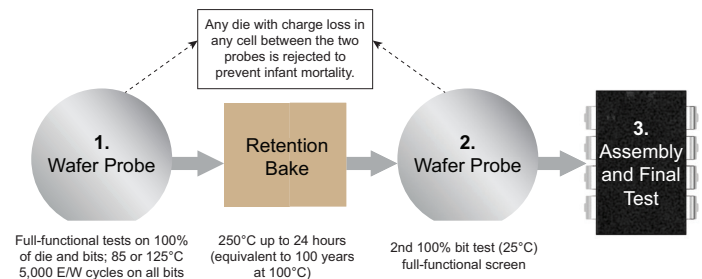

Main Goal: Zero Defects

- Full verification of datasheet parameters for functional compliance at die and package level
- Removal of manufacturing defects to ensure highest quality and reliability
- Screening out of functional devices that may fail in the future

Serial EEPROM

Serial EEPROM Bus Comparison

Parameter	I ² C™	Microwire	UNI/O® Bus	SPI
Density Range	128 bits–1 Mbit	1 Kbit–16 Kbits	1 Kbit–16 Kbits	1 Kbit–1 Mbit
Speed	Up to 1 MHz	Up to 3 MHz	Up to 100 kHz	Up to 20 MHz
I/O Pins	2: Clock, Data	4: Clock, CS, DI, DO	1: Clock/Data	4: SCK, CS, DI, DO
Package Options	PDIP, SOIC, SOIJ, TSSOP, MSOP, 2 × 3 TDFN, 6 × 5 DFN, SOT-23, SC70, WLCSP	PDIP, SOIC, TSSOP, MSOP, 2 × 3 TDFN, SOT-23	PDIP, SOIC, TSSOP, MSOP, 2 × 3 TDFN, SOT-23, TO92, WLCSP	PDIP, SOIC, SOIJ, TSSOP, MSOP, 2 × 3 TDFN, 6 × 5 DFN, SOT-23
Security Options	Hardware	Hardware	Software	Hardware/Software
Pricing	Fewest features/lowest cost			Most features/highest cost

Microchip's best-in-class field performance is the combined result of Wafer Level Burn-In and Wafer Probe-Quality Screens.

Microchip Serial EEPROM Field Return Data

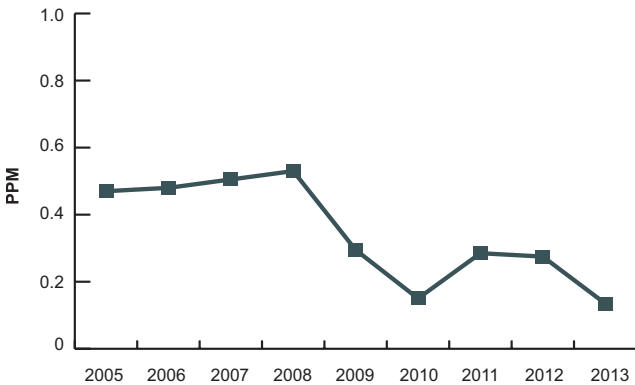

- Industry's lowest field return numbers, best suited for automotive applications

Microchip Serial EEPROM Endurance

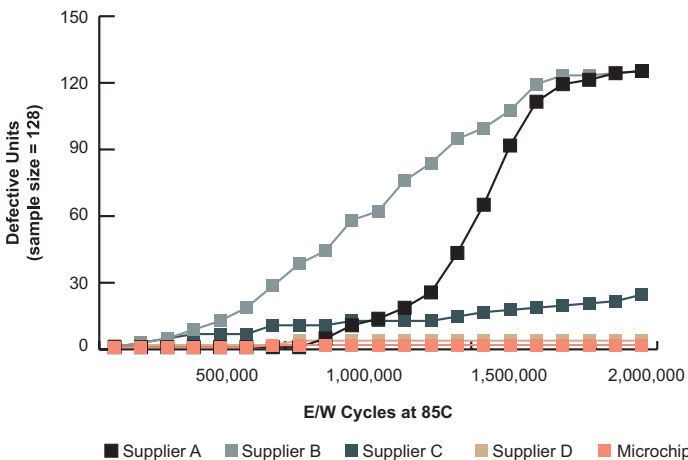

- All devices from supplier A and B failed before 2 million E/W cycles at 85°C
- Testing shows zero Microchip EEPROM fails even at 2 million E/W cycles at 85°C

Standard and Specialty/Application-Specific EEPROMs

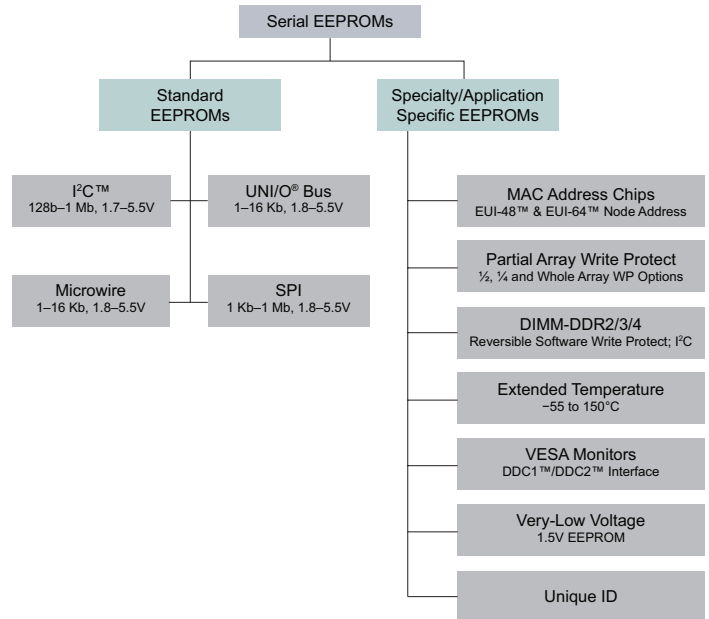

Total Endurance™ Software Model

Total Endurance Software Model provides a comprehensive model that helps estimate the endurance and reliability of Microchip Serial EEPROM devices. By providing operating conditions based on your application, all design trade-offs affecting reliability can be accurately estimated both graphically and numerically in PPM, FIT and MTBF modes, saving time and ensuring a truly robust design. The Total Endurance Software Model is available for free online at www.microchip.com/EEPROM.

Specialty EEPROM

EUI-48™/EUI-64™ MAC Address Chips

Need fast, easy and inexpensive access to MAC addresses? Microchip's pre-programmed MAC address chips have a unique ID and require no serialization.

EUI-48™ programmed Serial EEPROMs provide low cost and easy access to IEEE MAC addresses. These plug-and-play devices allow you to quickly add a MAC address to your networking application eliminating the need for programming and serialization on the MCU—helping you save cost and get to market faster. For more information visit www.microchip.com/MAC.

I ² C™	24AA02E48/E64	100 kHz
SPI	25AA02E48/E64	10 MHz
UNI/O® Bus	11AA02E48/E64	100 kHz
Microwire	93AA46AE48	2 MHz

Plug-and-Play Devices

EUI-48 address embedded in a 2 Kbit Serial EEPROM

- Quick and easy access to IEEE MAC address, read code directly off Serial EEPROM
- Available in SPI, I²C and UNI/O bus
- At least 1.5 Kbit of Serial EEPROM memory
- Available in SOIC and SOT-23 packages
- Write-protected codes
- EUI-48 and EUI-64™ compatible
 - EUI-48: networking, Ethernet, Wi-Fi® (IEEE 802.11), Bluetooth®
 - EUI-64: ZigBee® (IEEE 802.15.4), MiWi™ Protocol, FireWire, IPv6
- Can be custom programmed in any memory density

Contact Microchip sales for more information.

Partial Array Write-Protect I²C EEPROMs

Microchip's family of partial array Write-Protect (WP) EEPROMs offers hardware write-protect capability for only a part of the memory array. These I²C EEPROM devices are available from 1 Kbit–64 Kbit.

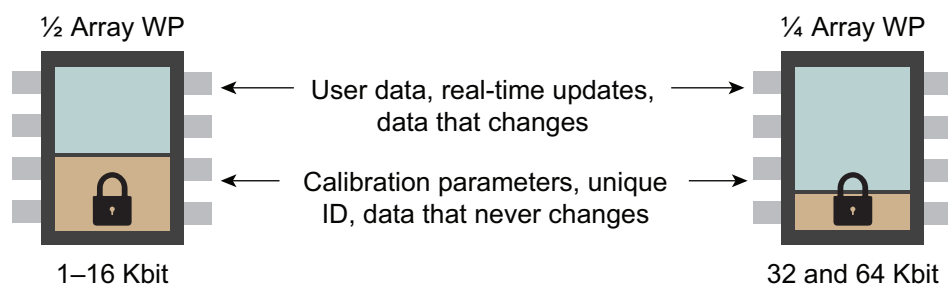

I²C and SPI Serial EEPROMs with Options Ranging From –55°C to +150°C

- Automotive turbo chargers and exhaust gas recirculation
- Automotive fan motors, air valves, flaps and spark plugs
- Aerospace
- Mining (certifications for use in explosive atmospheres available)



Flexibility and Easy to Manage

Quickly add EUI-48 to your networking application and get to market faster.

- Buy code only when needed
- No added programming and serialization costs, reduce system costs
- Code with no volume restrictions
- Unique ID

Serial EEPROM Products

I²C™ Memory Products

Device	Density (Organization)	Max. Clock Frequency	Operating Voltage (AA, LC, C)	Temperature (I, E, H) (°C)	Endurance (E/W Cycles)	Data Retention	Write-Protect (Hardware)	Packages
24XX00	128 bits (×8)	400 kHz	1.7–5.5 V	–40 to 125	1 M	200 years	–	PDIP, SOIC, TSSOP, SOT-23, 2 × 3 TDFN
24XX01/014	1 Kbit (×8)	400 kHz	1.7–5.5 V	–40 to 125	1 M	200 years	W, ½	PDIP, SOIC, TSSOP, SOT-23, 2 × 3 TDFN, MSOP, SC70
24XX02/024	2 Kbits (×8)	400 kHz	1.7–5.5 V	–40 to 125	1 M	200 years	W, ½	PDIP, SOIC, TSSOP, SOT-23, 2 × 3 TDFN, MSOP, SC70
24XX04	4 Kbits (×8)	400 kHz	1.7–5.5 V	–40 to 125	1 M	200 years	W, ½	PDIP, SOIC, TSSOP, SOT-23, 2 × 3 TDFN, MSOP, WLCSOP
24XX08	8 Kbits (×8)	400 kHz	1.7–5.5 V	–40 to 125	1 M	200 years	W, ½	PDIP, SOIC, TSSOP, SOT-23, 2 × 3 TDFN, MSOP
24XX16	16 Kbits (×8)	400 kHz	1.7–5.5 V	–40 to 125	1 M	200 years	W, ½	PDIP, SOIC, TSSOP, SOT-23, 2 × 3 TDFN, MSOP, WLCSOP
24XX32	32 Kbits (×8)	400 kHz	1.7–5.5 V	–40 to 125	1 M	200 years	W, ¼	PDIP, SOIC, TSSOP, SOT-23, 2 × 3 TDFN, MSOP, WLCSOP
24XX64/65	64 Kbits (×8)	1 MHz	1.7–5.5 V	–40 to 125	1 M/10 M	200 years	W, ¼	PDIP, SOIC, TSSOP, SOT-23, 2 × 3 TDFN, MSOP, WLCSOP
24XX128	128 Kbits (×8)	1 MHz	1.7–5.5 V	–40 to 125	1 M	200 years	✓	PDIP, SOIC, TSSOP, 2 × 3 TDFN, 6 × 5 DFN, WLCSOP
24XX256	256 Kbits (×8)	1 MHz	1.7–5.5 V	–40 to 125	1 M	200 years	✓	PDIP, SOIC, TSSOP, 6 × 5 DFN, MSOP, WLCSOP
24XX512	512 Kbits (×8)	1 MHz	1.7–5.5 V	–40 to 125	1 M	200 years	✓	PDIP, SOIC, TSSOP, 6 × 5 DFN, WLCSOP
24XX1024	1 Mbit (×8)	1 MHz	1.7–5.5 V	–40 to 125	1 M	200 years	✓	PDIP, SOIC, SOIJ, 6 × 5 DFN

UNI/O® Bus EEPROM Products

Device	Density (Organization)	Max. Clock Frequency	Operating Voltage (AA, LC, C)	Temperature (I, E) (°C)	Endurance (E/W Cycles)	Data Retention	Write-Protect (Software)	Packages
11XX010	1 Kbit (×8)	100 kHz	1.8–5.5 V	–40 to 125	1 M	200 years	W, ½, ¼	PDIP, SOIC, TSSOP, SOT-23, 2 × 3 TDFN, MSOP, TO92, WLCSOP
11XX020	2 Kbits (×8)	100 kHz	1.8–5.5 V	–40 to 125	1 M	200 years	W, ½, ¼	PDIP, SOIC, TSSOP, SOT-23, 2 × 3 TDFN, MSOP, TO92, WLCSOP
11XX040	4 Kbits (×8)	100 kHz	1.8–5.5 V	–40 to 125	1 M	200 years	W, ½, ¼	PDIP, SOIC, TSSOP, SOT-23, 2 × 3 TDFN, MSOP, TO92, WLCSOP
11XX080	8 Kbits (×8)	100 kHz	1.8–5.5 V	–40 to 125	1 M	200 years	W, ½, ¼	PDIP, SOIC, TSSOP, SOT-23, 2 × 3 TDFN, MSOP, TO92, WLCSOP
11XX160	16 Kbits (×8)	100 kHz	1.8–5.5 V	–40 to 125	1 M	200 years	W, ½, ¼	PDIP, SOIC, TSSOP, SOT-23, 2 × 3 TDFN, MSOP, TO92, WLCSOP

Microwire EEPROM Products

Device	Density (×8 or ×16)	Max. Clock Frequency	Operating Voltage (AA, LC, C)	Temperature (I, E) (°C)	Endurance (E/W Cycles)	Data Retention	Write-Protect (Hardware)	Read Current	Packages
93XX46A/B/C	1 Kbit	3 MHz	1.8–5.5 V	–40 to 125	1 M	200 years	–	1 mA	PDIP, SOIC, TSSOP, SOT-23, 2 × 3 TDFN, MSOP
93XX56A/B/C	2 Kbits	3 MHz	1.8–5.5 V	–40 to 125	1 M	200 years	–	1 mA	PDIP, SOIC, TSSOP, SOT-23, 2 × 3 TDFN, MSOP
93XX66A/B/C	4 Kbits	3 MHz	1.8–5.5 V	–40 to 125	1 M	200 years	–	1 mA	PDIP, SOIC, TSSOP, SOT-23, 2 × 3 TDFN, MSOP
93XX76A/B/C	8 Kbits	3 MHz	1.8–5.5 V	–40 to 125	1 M	200 years	✓	1 mA	PDIP, SOIC, TSSOP, SOT-23, 2 × 3 TDFN, MSOP
93XX86A/B/C	16 Kbits	3 MHz	1.8–5.5 V	–40 to 125	1 M	200 years	✓	1 mA	PDIP, SOIC, TSSOP, SOT-23, 2 × 3 TDFN, MSOP

A: ×8 Organization, B: ×16 Organization, C: Selectable ×8 or ×16 Organization

SPI EEPROM Products

Device	Density (Organization)	Max. Clock Frequency	Operating Voltage (AA, LC, C)	Temperature (I, E, H) (°C)	Endurance (E/W Cycles)	Data Retention	Write-Protect (Software)	Packages
25XX010A	1 Kbit (×8)	10 MHz	1.8–5.5 V	–40 to 125	1 M	200 years	W, ½, ¼	PDIP, SOIC, TSSOP, 2 × 3 TDFN, MSOP, SOT-23
25XX020A	2 Kbits (×8)	10 MHz	1.8–5.5 V	–40 to 125	1 M	200 years	W, ½, ¼	PDIP, SOIC, TSSOP, 2 × 3 TDFN, MSOP, SOT-23
25XX040A	4 Kbits (×8)	10 MHz	1.8–5.5 V	–40 to 125	1 M	200 years	W, ½, ¼	PDIP, SOIC, TSSOP, 2 × 3 TDFN, MSOP, SOT-23
25XX080C/D	8 Kbits (×8)	10 MHz	1.8–5.5 V	–40 to 125	1 M	200 years	W, ½, ¼	PDIP, SOIC, TSSOP, 2 × 3 TDFN, MSOP
25XX160C/D	16 Kbits (×8)	10 MHz	1.8–5.5 V	–40 to 125	1 M	200 years	W, ½, ¼	PDIP, SOIC, TSSOP, 2 × 3 TDFN, MSOP
25XX320A	32 Kbits (×8)	10 MHz	1.8–5.5 V	–40 to 125	1 M	200 years	W, ½, ¼	PDIP, SOIC, TSSOP, 2 × 3 TDFN, MSOP
25XX640A	64 Kbits (×8)	10 MHz	1.8–5.5 V	–40 to 125	1 M	200 years	W, ½, ¼	PDIP, SOIC, TSSOP, 2 × 3 TDFN, MSOP
25XX128	128 Kbits (×8)	10 MHz	1.8–5.5 V	–40 to 125	1 M	200 years	W, ½, ¼	PDIP, SOIC, TSSOP, 6 × 5 DFN
25XX256	256 Kbits (×8)	10 MHz	1.8–5.5 V	–40 to 125	1 M	200 years	W, ½, ¼	PDIP, SOIC, TSSOP, 6 × 5 DFN
25XX512	512 Kbits (×8)	20 MHz	1.8–5.5 V	–40 to 125	1 M	200 years	W, ½, ¼	PDIP, SOIC, 6 × 5 DFN
25XX1024	1 Mbit (×8)	20 MHz	1.8–5.5 V	–40 to 125	1 M	200 years	W, ½, ¼	PDIP, SOIJ, 6 × 5 DFN

1. Voltage Range: AA = 1.7–5.5 V, LC = 2.5–5.5 V, C = 4.5–5.5 V
2. I = –40°C to 85°C, E = –40°C to 125°C, H = –40°C to 150°C
3. All devices are RoHS-compliant

4. Write Protect: W = Whole Array, ½ = Half Array, ¼ = Quarter Array
5. ESD Protection > 4 kV (HBM), > 400 V (MM) on all pins
6. H temperature is SOIC only

Serial EEPROM Packages

More Memory in Less Space!

Serial EEPROM devices from Microchip are available in a wide variety of tiny, innovative packages to help minimize your design, save board space and reduce cost.

- WLCSP: die-sized packages, smallest form factor EEPROM package in the world
- SC-70: among the smallest 5-lead EEPROM package
- 5-pin SOT-23 available up to 64 Kbit, 8-pin TDFN up to 128 Kbit, 8-pin SOIC up to 1 Mbit (I²C)

Density	Max. Speed	SOIC (SN)	SOT-23 (OT/TT)	TSSOP (TS)	TDFN (MNY/MC)	PDIP (P)	MSOP (MS)	SOIJ (SM)	DFN (MF)	SC70 (LT)	T092 (TO)	Wafer (W/S/WF)
		5 × 6	3 × 3	3 × 6.5	2 × 3	8 × 9.5	3 × 5	5 × 8	5 × 6	2 × 2		Die
I²C™ Bus 1.75.5 V												
128bit-2 K	400 kHz	✓	5	✓	✓	✓	✓	-	-	5	-	✓
4-32 K	400 kHz	✓	5	✓	✓	✓	✓	-	-	-	-	✓
64 K	1 MHz	✓	5	✓	✓	✓	✓	✓	-	-	-	✓
128 K	1 MHz	✓	-	✓	✓	✓	✓	✓	✓	-	-	✓
256 K	1 MHz	✓	-	✓	-	✓	✓	✓	✓	-	-	✓
512 K	1 MHz	✓	-	✓	-	✓	-	✓	✓	-	-	✓
1 Mbit	1 MHz	✓	-	-	-	✓	-	✓	-	-	-	-
Microwire Bus 1.8-5.5 V												
1-16 K	3 MHz	✓	6	✓	✓	✓	✓	-	-	-	-	✓
SPI Bus 1.8-5.5 V												
1-4 K	10 MHz	✓	6	✓	✓	✓	✓	-	-	-	-	✓
8-64 K	10 MHz	✓	-	✓	✓	✓	✓	-	-	-	-	✓
128 K, 256 K	10 MHz	✓	-	✓	-	✓	-	✓	✓	-	-	✓
512 K	20 MHz	✓	-	14	-	✓	-	✓	✓	-	-	✓
1 Mbit	20 MHz	-	-	-	-	✓	-	✓	✓	-	-	✓
UNI/I® Single-Wire Bus 1.8-5.5 V												
1-16 K	100 kHz	✓	3	-	✓	✓	✓	-	-	-	✓	✓

Package Sizes

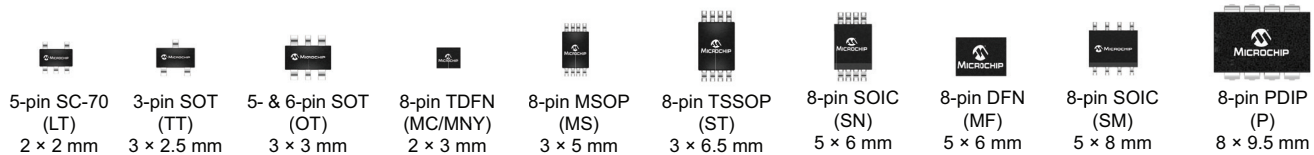

WLCSP: World's Smallest EEPROM Package

The Wafer-Level Chip Scale Package (WLCSP) from Microchip is a bumped die with a redistribution layer to route the bond pads to the bumps.

- True “die-sized” packages
- Industry’s smallest package form factor
- Lowest profile package
- Available in I²C, UNI/O bus
- Compatible with standard surface-mount assembly lines
- Fit a large density into a small space

Typical Applications

- Mobile phones
- Security camera
- Sensors
- Servers
- Networking
- RF
- Medical
- Portable electronics

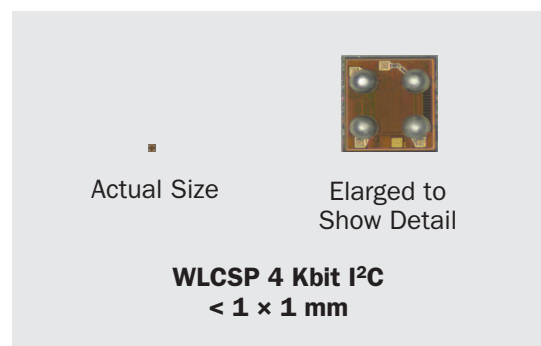

Serial SRAM

Microchip's Serial SRAM family provides a way to easily and inexpensively add external RAM to almost any application. These serial devices use less power and fewer I/O connections than traditional parallel SRAM, and they allow you to use a smaller microcontroller with additional on-board RAM. Microchip's SPI-compatible Serial SRAM devices are available in 64 Kbit, 256 Kbit, 512 Kbit and 1 Mbit options and up to 20 MHz. The 512 Kbit and 1 Mbit parts support data backup via an external battery/coin cell connected V_{BAT} pin. These 8-pin devices have unlimited endurance and zero write times.



	1.5–1.95 V	2.7–3.6 V
1 Mb	23A1024/20 MHz	23LC1024/20 MHz
512 Kb	23A512/20 MHz	23LC512/20 MHz
256 Kb	23A256/16 MHz	23K256/20 MHz
64 Kb	23A640/16 MHz	23K640/20 MHz

Key Features

- SPI Bus, 20 MHz
- Volatile memory
- Operating voltage: 1.5–1.95 V, 2.7–3.6 V
- Infinite endurance
- Zero write speeds
- Low power consumption

Key Benefits

- Lower system costs – innovative products, tiny packages, low-power consumption, fewer I/O pins, small form factor
- Save I/O pins on the MCU – more compact designs, add additional features
- Secure data with write-protect options
- Robust designs with broad operating conditions

Typical Applications

- Metering
- Point-Of-Sale (POS) terminals
- Printers
- Internet radio
- Ethernet
- Wi-Fi
- Replace parallel RAM
- Any application needing low-cost RAM

Flexible RAM Expansion

Add features to your current microcontroller and get to market faster.

- Add functionality to your current design
- No need to buy a larger microcontroller just for the RAM
- Familiar 4-pin SPI interface
- Reduce cost in your current design
- Scratchpad, buffering, high-endurance applications

The Serial SRAM Advantage

Feature	Traditional Parallel SRAM	Microchip's Serial SRAM
I/O Connection to MCU	16–20	4
Standby Current	3 mA	1 μA
Active Current	50 mA	1–10 mA
Lowest Operating Voltage	3.0 V	1.7 V
Footprint	100 mm ²	20 mm ²
Smallest Packages	28-pin TSSOP, 28-pin SOIC	8-pin TSSOP, 8-pin SOIC
		<p>Stand-alone Serial SRAM offering greater design flexibility and the opportunity for RAM expansion</p>

Serial SRAM Products

Device	Density (Organization)	Max. Clock Frequency	Operating Voltage (A, K)	Temperature (I, E) (°C)	Read Current (mA)	Max. Standby Current	Packages	Battery Back-Up
23X640	8 KB (64 Kbits)	20 MHz	1.8 V, 3 V	–40 to 125	3 mA	4 μA	PDIP, SOIC, TSSOP	No
23X256	32 KB (256 Kbits)	20 MHz	1.8 V, 3 V	–40 to 125	3 mA	4 μA	PDIP, SOIC, TSSOP	No
23X512	64 KB (512 Kbits)	20 MHz	1.8 V, 3 V, 5 V	–40 to 125	3 mA	4 μA	PDIP, SOIC, TSSOP	Yes
23X1024	125 KB (1 Mbit)	20 MHz	1.8 V, 3 V, 5 V	–40 to 125	3 mA	4 μA	PDIP, SOIC, TSSOP	Yes

1. Voltage Range: A = 1.5–1.95 V, K = 2.7–3.6 V

2. All devices are RoHS-compliant

NOR Flash

What Is SuperFlash Technology?

Microchip's SuperFlash technology is an innovative, highly reliable and versatile type of NOR Flash memory. SuperFlash technology memory is much more flexible and reliable than competing non-volatile memories. This technology utilizes a split-gate cell architecture which uses a robust thick-oxide process that requires fewer mask steps resulting in a lower-cost nonvolatile memory solution with extremely fast erase time, excellent data retention and higher reliability.

SuperFlash Technology Advantages

- Fast, fixed program and erase times
 - ~ 40 ms for SuperFlash technology vs. more than a minute for conventional 64 Mb
 - Results in improved manufacturing efficiency and lower costs
- No pre-programming or verification required prior to erase
 - Results in significantly lower power consumption
- Superior reliability
 - 100 K cycles and 100 years data retention
- Inherent small-sector size
 - 4 KB erase sector vs. 64 KB
 - Results in faster re-write operations and contributes to lowering overall power consumption

Flash Performance Comparison

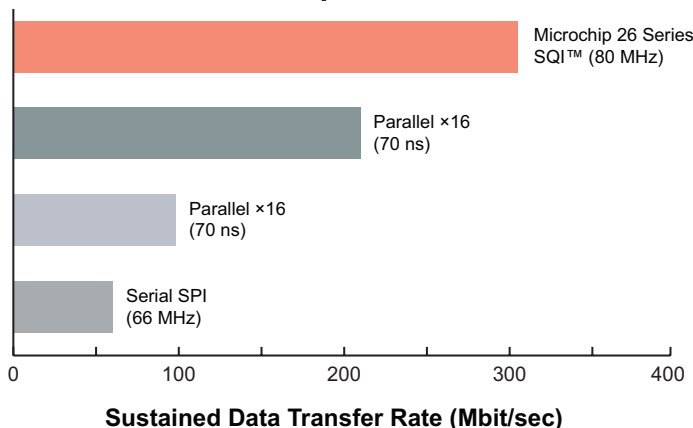

Serial and Parallel Flash

Serial Flash (25 and 26 Series) are designed for a wide variety of applications in consumer electronics, computing, networking and industrial spaces. Small form factor, standard pinouts and command sets make Serial Flash easy to design in and cost competitive.

Our Parallel Flash (39 and 38 Series) are ideal for GPS/navigation and other mobile devices that require execute-in-place (XIP) performance and for demanding industrial and automotive applications.

Memory Cell Structure Comparison

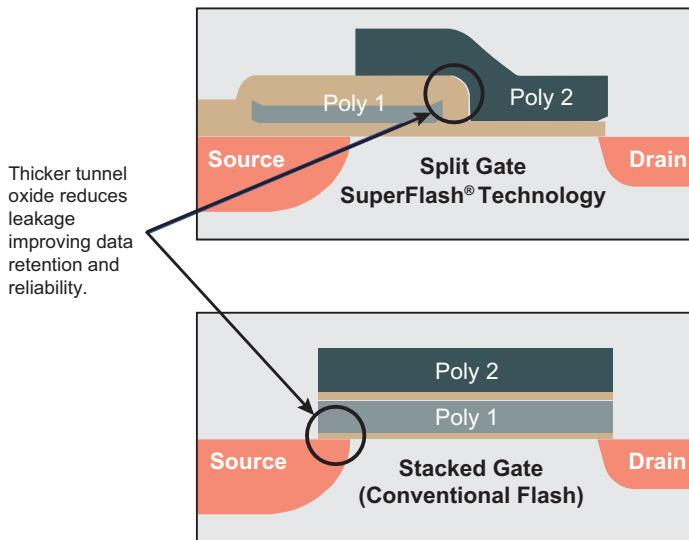

100× Times Faster Erase Times Than Competitors and Chip Erase Time Remains the Same Across All Densities

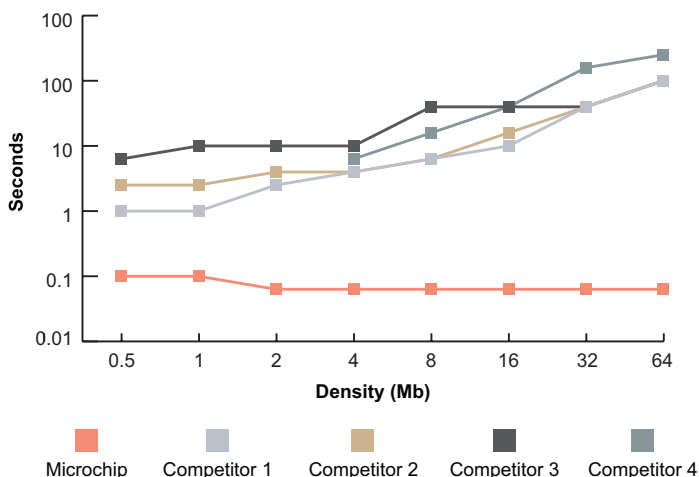

8 Mb and 16 Mb Firmware Flash

Microchip is the sole remaining supplier of 8 Mb and 16 Mb Firmware Flash. These SuperFlash technology memory devices are compliant with the Intel Low Pin Count (LPC) Interface Specification and are intended to store system BIOS in applications such as PCs, point-of-sale systems, set-top boxes, network boards and other embedded CPU applications.

- FWH devices (49LF008A and 49LF016C) incorporate Intel's proprietary FWH interface protocol used in the Intel 8XX Series Hub Architecture chipsets.
- LPC Flash devices (49LF080A and 49LF160C) comply with the standard Intel Low Pin Count Interface Specification 1.1.

Serial Flash

Serial Flash

Serial Flash Key Features

- Serial peripheral interface: Mode 0 and Mode 3
- Small footprint
 - 8-pin SOIC, low-profile 8-contact WSON, 8-bump XFBGA Z-Scale
- Operating voltage
 - 1.65–1.95V, 2.3–3.6V
- Clock frequency up to 104 MHz
- Flexible erase capability
 - 4 Kbyte uniform sector erase
 - 32/64 Kbyte block erase
 - Chip erase
- Endurance: 100,000 cycles (typical)
- Data retention: 100 years (min)
- Fast sector erase or block erase time: 18 ms (typical)
- Byte program time: 7 μ s (typical)
- Active read current: 10 mA (typical)
- Standby current: 5 μ A (typical) throughput
- Proven technology
 - CMOS SuperFlash technology boosts data retention and endurance, and reduces erase time and power consumption, making Microchip Serial Flash ideal for portable designs.



Serial Flash Applications

- Home networking
- HDTVs
- Bluetooth
- Wearable devices
- DSL and cable modems
- Tablets
- Hard disk drives
- Desktop PCs
- Notebook PCs
- Netbooks
- Printers
- Wireless LAN
- Set-top boxes
- LCD monitors
- Digital radios



Serial SPI Flash

25 Series

Serial SPI Flash is a small, low-power Flash memory that features a Serial Peripheral Interface (SPI) and pin-for-pin compatibility with industry-standard SPI EEPROM devices. Its small footprint reduces ASIC controller pin count and packaging costs, saves board space and keeps system costs down. Offering lower power consumption and fewer wires than Parallel Flash, Serial SPI Flash is the ideal cost-efficient data transfer solution.

Serial SPI Flash-Specific Features

- Densities up to 16 Mb
- Single footprint package up to 32 Mb
- Full SPI protocol compatibility

Serial Quad I/O™ (SQI™) Flash

26 Series

SQI Flash memory uses 4-bit multiplexed I/O serial protocol, boosts performance while maintaining the compact form factor of standard SPI Flash. SQI devices can be used in Quad, Dual or SPI mode so it is backward compatible with SPI devices.

SQI Flash-Specific Features

- 4-bit multiplexed I/O serial protocol
- > 300 Mbps sustained read
- Density: 4 Mb to 64 Mb
- Software parameter and individual block locking
- Security ID
- Page mode programming
- Serial Flash Discoverable Parameters (SFDP)

Parallel Flash

Parallel Flash

Multi-Purpose Flash Devices (MPF™ Devices) Multi-Purpose Flash Plus Devices (MPF+ Devices) 39 Series

Multi-Purpose Flash and Multi-Purpose Flash Plus make up a family of Parallel Flash memory products that deliver high performance, low-power consumption, superior reliability and small sector size. Based on Microchip's SuperFlash technology, MPF and MPF+ provide faster program, erase and read times than conventional Flash, thereby saving power consumption and increasing manufacturing throughput.

In addition to offering 3 V and 5 V memory products, MPF devices and MPF+ devices provide 1.8 V that deliver significant power savings compared to industry standard Flash. Ideal for space-constrained applications, this family offers the industry's smallest standard packages, the XFLGA and WFBGA, both as small as 4 × 6 mm.

Advanced Multi-Purpose Flash Plus Devices (Advanced MPF+ Devices) 38 Series

Advanced MPF+ memory devices incorporate advanced security and protection features, page read access and better write programming into the standard MPF+ family. Currently these devices are available on 64 Mbit only.

Parallel Flash Applications

- Bluetooth
- GPS
- Wi-Fi/WiMax
- Mobile phones
- DSL/cable modems
- Servers and routers
- Set-top boxes
- Digital cameras
- Industrial
- Automotive infotainment



Parallel Flash Key Features

- Densities from 512 Kb through 64 Mb
- Hardware reset/boot block/erase suspend
- Security ID and page read/write on 64 Mb
- Operating voltages:
 - 1.65–1.95 V, 2.7–3.6 V, 4.5–5.5 V
- Low power consumption
 - Active current: 5 mA (typical)
 - Standby current: 3 µA (typical)
- Fast read access times
 - 55 ns and 70 ns (39 series), 25 ns (38 series)
- Fast programming*
 - 7 µs per word (typical, 39 series)
 - 1.75 µs per word (typical, 38 series)
- Flexible erase capability and fast erase times*
 - 2 Kword sector erase: 18 ms (typical)
 - 32 Kword block erase: 18 ms (typical)
 - Chip erase: 70 ms (typical)
- Small uniform sector sizes: 2 Kword and 32 Kword
- Commercial and industrial operating temperatures
- Endurance: 100,000 cycles (typical)
- Data retention: 100 years (min)
- MPF+ devices offer additional features
 - Erase suspend
 - Boot block
 - Hardware reset features
- Advanced protection features (series 38)



*Data varies for different devices, please refer to the datasheet for details.

Automotive Memory Products

Microchip Technology has developed industry-leading processes for each step in the design, manufacturing and testing phases of its serial EEPROMs, and has become one of the most respected leaders in supply of these devices to the automotive industry worldwide.

EEPROM: Robust Design

- ESD protection
 - > 4000 V Human Body Model (HBM)
 - > 400 V Machine Mode (MM)
 - > 1000 V Charged Device Model
- Latch-up protection > 200 mA on all pins
- ESD induced latch-up > 100 V (MM) on V_{DD}; > 400 V on all I/O > 1 M cycles endurance and > 200 years data retention
- Up to 150°C operation (read and writes)
- Power-On Reset (POR) and Brown-Out Reset (BOR)
 - Effective protection against noisy automotive environments
 - Eliminates false writes
- Schmitt Trigger input filters for noise reduction
- Complete traceability including die location on wafer

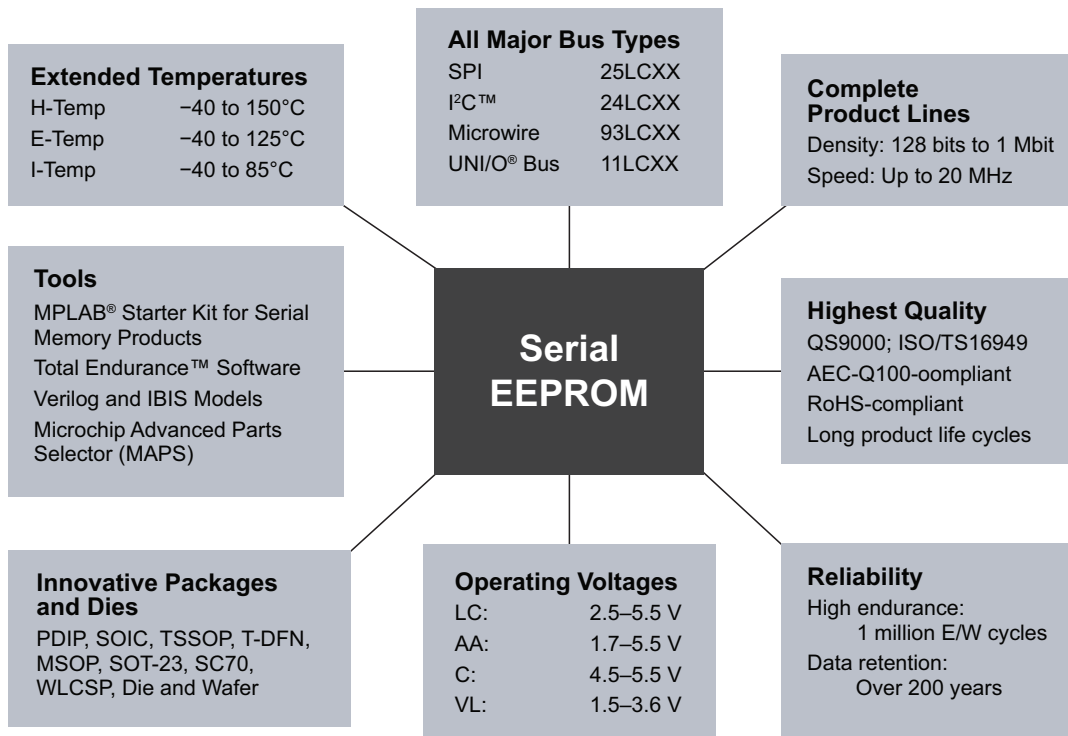

Automotive Memory Products

Automotive Grade*

- ISO TS-16949-compliant (inc. VDA6.1) quality manufacturing systems
- Restricted site assembly
- Production Parts Approval Process (PPAP)
- Exceeds AEC Q-100 product qualification requirements
- Special screening and test methods including Maverick lot testing
- Long product life cycle in support of automotive industry 15 year supply requirement

Temperature Range

Now offering I²C and SPI Serial EEPROMs with optional range from -55 to 150°C.

- Automotive turbo chargers and exhaust gas recirculation
- Automotive fan motors, air valves, flaps and spark plugs
- Areas under the vehicle hood

Serial SRAM

Looking for RAM memory also? Microchip's SPI Serial SRAM products offer:

- A quick and easy way to add external RAM
- 4-pin SPI interface
- 20 MHz clock speed
- No write cycle time

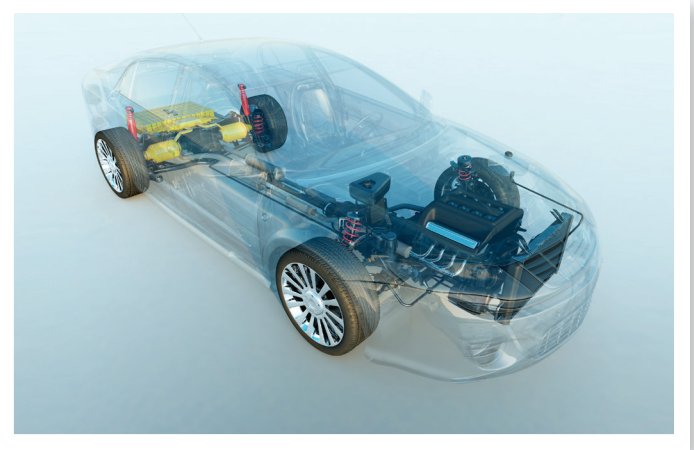

Flash

Unique Flash Cell Design

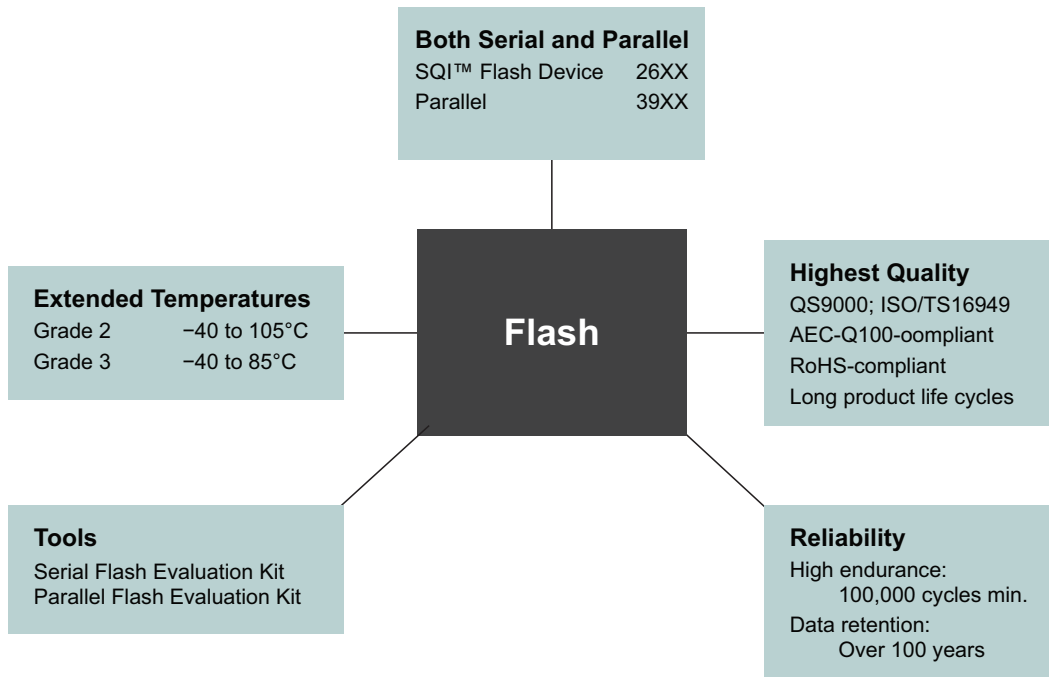
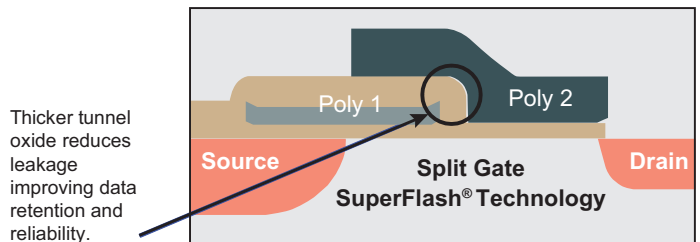

*Automotive grade criteria will evolve as market requirements change.

Resources

Development Tools

Reduce development time and cost with Microchip's development tools. Competitive market conditions force businesses to examine every aspect of their product life cycle to maximize productivity and minimize expense. Easy-to-learn, low-cost common development tools are one way to reduce risk and get to market faster.

MPLAB® Starter Kit for Serial Memory Products (DV243003)



Reduce time to market and create a rock-solid design using the MPLAB Starter Kit for Serial Memory Products. It includes everything necessary to quickly develop a robust and reliable Serial EEPROM design, and

greatly reduces the time required for system integration and hardware/software fine-tuning.

- 3.3 V and 5.0 V on-board voltage selection
- Supports Microchip UNI/O bus, I²C, SPI and Microwire Serial EEPROMs
- 1.8 V to 5.5 V external voltage support
- Includes free copy of MPLAB X IDE
- USB interconnect

UNI/O Bus Parasitic Power Demonstration Board (AC243004)



The UNI/O Bus Parasitic Power Demonstration Board is designed to illustrate how a standard half-wave rectifier and capacitor circuit can be used to parasitically extract power for

a UNI/O device from the Serial Clock, Data Input/Output (SCIO) signal as described in application note AN1213. This reduces the number of connections necessary for adding a UNI/O device to your application down to two: SCIO and Vss.

Serial EEPROM Plug-In Module PICTail™ Board Pack (AC243003)

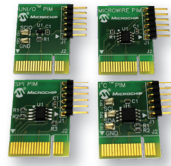

The Serial EEPROM Plug-In Module PICTail Board Pack is a series of boards designs around Microchip's Serial EEPROM devices. The boards are designed to interface with the PICTail Plus connector as well as the MPLAB Starter Kit for Serial Memory

Products and the PICKit™ 3 board, allowing you to get started right out of the box.

- Plug-and-play with PICTail Plus connector and PICKit 3 connector
- Test points for oscilloscope connections for firmware debugging (I²C and UNI/O only)
- Microwire Buses are included for maximum flexibility in development of your application

Serial SuperFlash Technology Kit 1

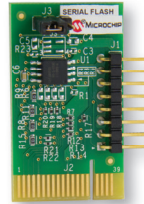

The Serial SuperFlash Technology Kit 1 allows you to evaluate Serial Flash and quickly develop and test firmware using known good hardware. This kit includes three Serial Flash PICTail Plus daughter boards, each having a Serial Flash soldered on it. The Serial Flash devices included are SST25VF016B, SST26VF032 and SST25VF064C.

Parallel SuperFlash Technology Kit 1 (AC243006-1)

The Parallel Flash PICTail Plus Daughter Board is an evaluation board designed to interface with the PICTail Plus connector found on the Explorer 16 Development Board. The Parallel SuperFlash Technology Kit 1 contains two Parallel Flash PICTail Plus Daughter Boards. Each board has a parallel Flash device soldered on it. The parallel Flash devices included are SST38VF6401 and SST39VF1601C.

Support

Microchip is committed to supporting its customers in developing products faster and more efficiently. We maintain a worldwide network of field applications engineers and technical support ready to provide product and system assistance. In addition, the following service areas are available at www.microchip.com:

- **Support** link provides a way to get questions answered fast: <http://support.microchip.com>
- **Sample** link offers evaluation samples of any Microchip device: <http://sample.microchip.com>
- **Forum** link provides access to knowledge base and peer help: <http://forum.microchip.com>
- **Buy** link provides locations of Microchip Sales Channel Partners: www.microchip.com/sales

Sales Office Listing

AMERICAS

Atlanta
Tel: 678-957-9614

Austin
Tel: 512-257-3370

Boston
Tel: 774-760-0087

Chandler
Tel: 480-792-7200

Chicago
Tel: 630-285-0071

Cleveland
Tel: 216-447-0464

Dallas
Tel: 972-818-7423

Detroit
Tel: 248-538-2250

Houston
Tel: 281-894-5983

Indianapolis
Tel: 317-773-8323

Los Angeles
Tel: 949-462-9523

New York
Tel: 631-435-6000

San Jose
Tel: 408-735-9110

Toronto
Tel: 905-673-0699

EUROPE

Austria - Wels
Tel: 43-7242-2244-39

Denmark - Copenhagen
Tel: 45-4450-2828

France - Paris
Tel: 33-1-69-53-63-20

Germany - Dusseldorf
Tel: 49-2129-3766400

Germany - Munich
Tel: 49-89-627-144-0

Germany - Pforzheim
Tel: 49-7231-424750

Italy - Milan
Tel: 39-0331-742611

Italy - Venice
Tel: 39-049-7625286

Netherlands - Drunen
Tel: 31-416-690399

Poland - Warsaw
Tel: 48-22-3325737

Spain - Madrid
Tel: 34-91-708-08-90

Sweden - Stockholm
Tel: 46-8-5090-4654

UK - Wokingham
Tel: 44-118-921-5800

Training

If additional training interests you, then Microchip can help. We continue to expand our technical training options, offering a growing list of courses and in-depth curriculum locally, as well as significant online resources – whenever you want to use them.

- Technical Training Centers and Other Resources: www.microchip.com/training
- MASTERS Conferences: www.microchip.com/masters
- Worldwide Seminars: www.microchip.com/seminars
- eLearning: www.microchip.com/webseminars

ASIA/PACIFIC

Australia - Sydney
Tel: 61-2-9868-6733

China - Beijing
Tel: 86-10-8569-7000

China - Chengdu
Tel: 86-28-8665-5511

China - Chongqing
Tel: 86-23-8980-9588

China - Dongguan
Tel: 86-769-8702-9880

China - Hangzhou
Tel: 86-571-87928115

China - Hong Kong SAR
Tel: 852-2943-5100

China - Nanjing
Tel: 86-25-8473-2460

China - Qingdao
Tel: 86-532-8502-7355

China - Shanghai
Tel: 86-21-5407-5533

China - Shenyang
Tel: 86-24-2334-2829

China - Shenzhen
Tel: 86-755-8864-2200

China - Wuhan
Tel: 86-27-5980-5300

China - Xiamen
Tel: 86-592-2388138

China - Xian
Tel: 86-29-8833-7252

China - Zhuhai
Tel: 86-756-3210040

ASIA/PACIFIC

India - Bangalore
Tel: 91-80-3090-4444

India - New Delhi
Tel: 91-11-4160-8631

India - Pune
Tel: 91-20-3019-1500

Japan - Osaka
Tel: 81-6-6152-7160

Japan - Tokyo
Tel: 81-3-6880-3770

Korea - Daegu
Tel: 82-53-744-4301

Korea - Seoul
Tel: 82-2-554-7200

Malaysia - Kuala Lumpur
Tel: 60-3-6201-9857

Malaysia - Penang
Tel: 60-4-227-8870

Philippines - Manila
Tel: 63-2-634-9065

Singapore
Tel: 65-6334-8870

Taiwan - Hsin Chu
Tel: 886-3-5778-366

Taiwan - Kaohsiung
Tel: 886-7-213-7828

Taiwan - Taipei
Tel: 886-2-2508-8600

Thailand - Bangkok
Tel: 66-2-694-1351

1/27/15

Microcontrollers • Digital Signal Controllers • Analog • Memory • Wireless

Information subject to change. The Microchip name and logo, the Microchip logo, MPLAB, SuperFlash and UNI/O are registered trademarks and MiWi, MPF, PICDEM, PICkit, PICtail, Serial Quad I/O, SQI and Total Endurance are trademarks of Microchip Technology Incorporated in the U.S.A. and other countries. All other trademarks mentioned herein are property of their respective companies. ©2015, Microchip Technology Incorporated. All Rights Reserved. Printed in the U.S.A. 2/15
DS20005356A

MICROCHIP
www.microchip.com

Microchip Technology Inc.
2355 W. Chandler Blvd.
Chandler, AZ 85224-6199