

PROTECTION PRODUCTS

Description

RailClamp® TVS diodes are ultra low capacitance devices designed to protect sensitive electronics from damage or latch-up due to ESD, EFT, and EOS. They are designed for use on high speed ports in applications such as cell phones, notebook computers, and other portable electronics. These devices offer desirable characteristics for board level protection including fast response time, low operating and clamping voltage, and no device degradation.

RClamp®2451ZA is specifically designed for protection of Near Field Communications (NFC) interfaces. It features extremely good ESD protection characteristics including a low typical dynamic resistance of 0.16 Ohms (typical), low peak ESD clamping voltage, and high ESD withstand voltage (+/-14kV contact per IEC 61000-4-2). Low typical capacitance (0.35pF at $V_R=0V$) means that RClamp2451ZA will not create harmonic distortion in the RF signal. This device is bidirectional and has a working voltage of 24V for use on NFC resonator circuits without signal clipping.

RClamp2451ZA is in a 2-pin SLP0603P2X3F package measuring 0.6 x 0.3 mm with a nominal height of 0.25mm. Leads are finished with lead-free NiAu. The combination of working voltage, low dynamic resistance, and low capacitance makes this device ideal for use on NFC antenna circuits, RF signal lines, and FM antennas in portable devices.

Package Dimension

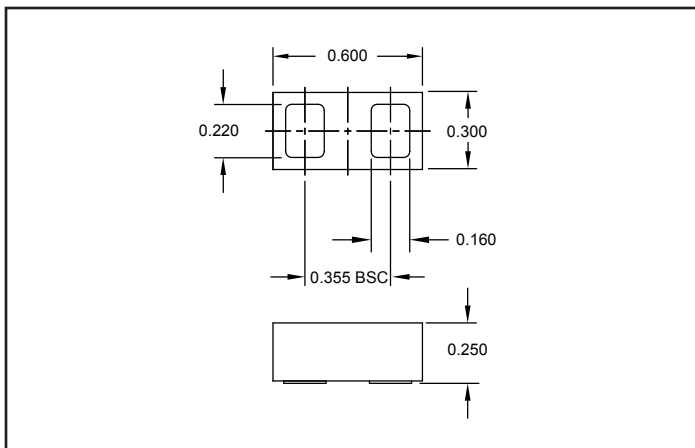

Features

- High ESD withstand voltage: +/-14kV (contact) and +/-18kV (air) per IEC 61000-4-2
- Able to withstand over 1000 ESD strikes per IEC 61000-4-2 Level 4
- Ultra-small 0201 package
- Protects one high speed data line
- Low ESD clamping voltage
- Working voltage: +/- 24V
- Low capacitance: 0.35pF Typical
- Low leakage current
- Low dynamic resistance: 0.16 Ohms Typical
- Solid-state silicon-avalanche technology

Mechanical Characteristics

- SLP0603P2X3F package
- Pb-Free, Halogen Free, RoHS/WEEE compliant
- Nominal Dimensions: 0.6 x 0.3 x 0.25 mm
- Lead Finish: NiAu
- Marking: Marking code
- Packaging: Tape and Reel

Applications

- Near Field Communication (NFC) lines
- RF signal lines
- FM Antenna

Schematic & Pin Configuration

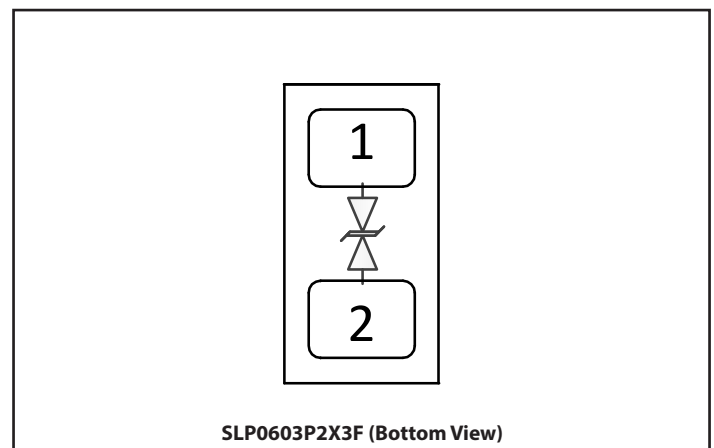

Absolute Maximum Rating

| Rating | Symbol | Value | Units |
|--|-----------|----------------------|-------|
| Peak Pulse Power ($t_p = 8/20\mu s$) | P_{PK} | 32 | W |
| Peak Pulse Current ($t_p = 8/20\mu s$) | I_{PP} | 4 | A |
| ESD per IEC 61000-4-2 (Air) ⁽¹⁾ ESD per IEC 61000-4-2 (Contact) ⁽¹⁾ | V_{ESD} | ± 18 ± 14 | kV |
| Operating Temperature | T_J | -40 to +85 | °C |
| Storage Temperature | T_{STG} | -55 to +150 | °C |

Electrical Characteristics (T=25°C unless otherwise specified)

| Parameter | Symbol | Conditions | Min. | Typ. | Max. | Units |
|-----------------------------------|-----------|--|------|------|------|----------|
| Reverse Stand-Off Voltage | V_{RWM} | Pin 1 to 2 or Pin 2 to 1 | | | 24 | V |
| Breakdown Voltage | V_{BR} | $I_{BR} = 10 \mu A$ | 25.5 | 27.5 | 31 | V |
| Reverse Leakage Current | I_R | $V_{RWM} = 24V$ | | <1 | 50 | nA |
| Clamping Voltage ² | V_C | $I_{PP} = 1A$, $t_p = 1.2/50\mu s$ (Voltage), $8/20\mu s$ (Current) Combination Waveform, $R_s = 12 \Omega$ | | 4.5 | 7 | V |
| Clamping Voltage ² | V_C | $I_{PP} = 4A$, $t_p = 1.2/50\mu s$ (Voltage), $8/20\mu s$ (Current) Combination Waveform, $R_s = 12 \Omega$ | | 5.5 | 8 | |
| ESD Clamping Voltage ³ | V_C | $I = 4A$, $t_p = 0.2/100ns$ | | 5 | | V |
| | | $I = 16A$, $t_p = 0.2/100ns$ | | 7 | | |
| Dynamic Resistance ^{3,4} | R_{DYN} | $t_p = 0.2/100ns$ | | 0.16 | | Ω |
| Junction Capacitance | C_J | $V_R = 0V$, $f = 1MHz$ | | 0.35 | 0.45 | pF |

Notes:

(1) ESD gun return path connected to Ground Reference Plane (GRP)

(2) Measured using a 1.2/50 μs voltage, 8/20 μs current combination waveform, $R_s = 12 \Omega$. Clamping is defined as the peak voltage across the device after the device snaps back to a conducting state.

(3) Transmission Line Pulse Test (TLP) Settings: $t_p = 100ns$, $t_r = 0.2ns$, I_{TLP} and V_{TLP} averaging window: $t_1 = 70ns$ to $t_2 = 90ns$.

(4) Dynamic resistance calculated from $I_{TLP} = 4A$ to $I_{TLP} = 16A$.

Typical Characteristics

ESD Clamping (8kV Contact per IEC 61000-4-2)

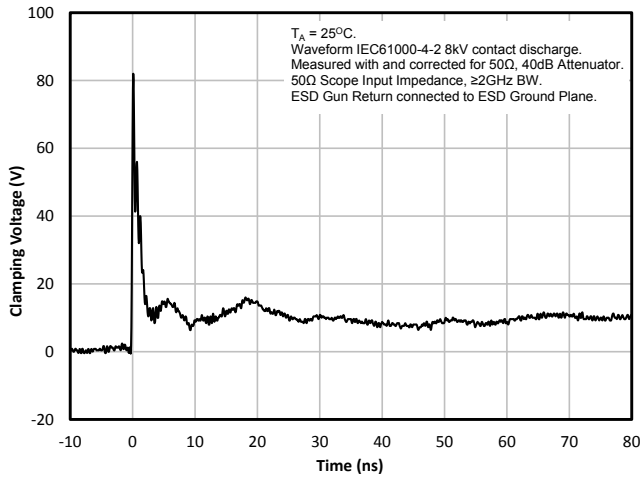

ESD Clamping (-8kV Contact per IEC 61000-4-2)

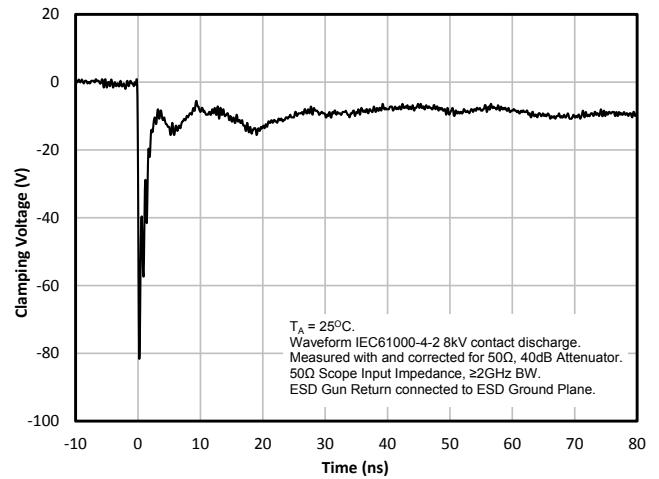

TLP Characteristic (Positive Pulse)

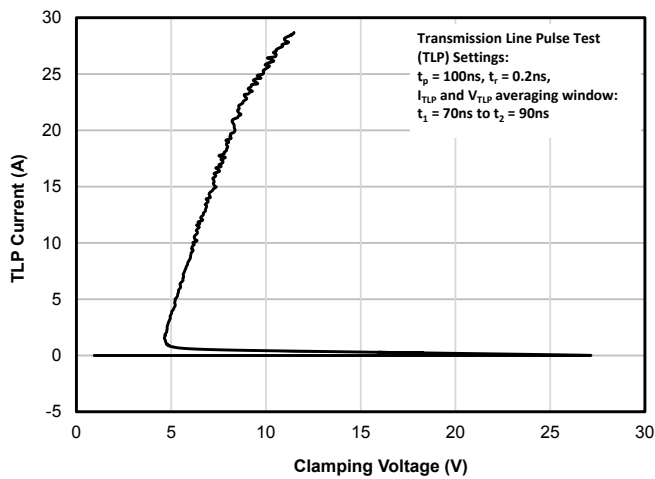

TLP Characteristic (Negative Pulse)

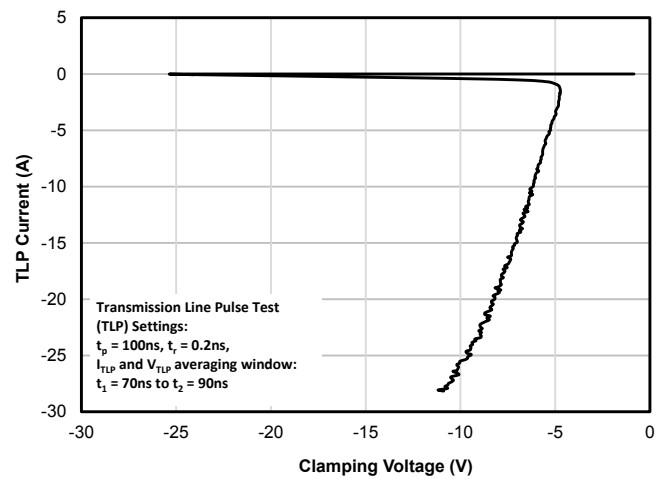

Junction Capacitance vs. Reverse Voltage

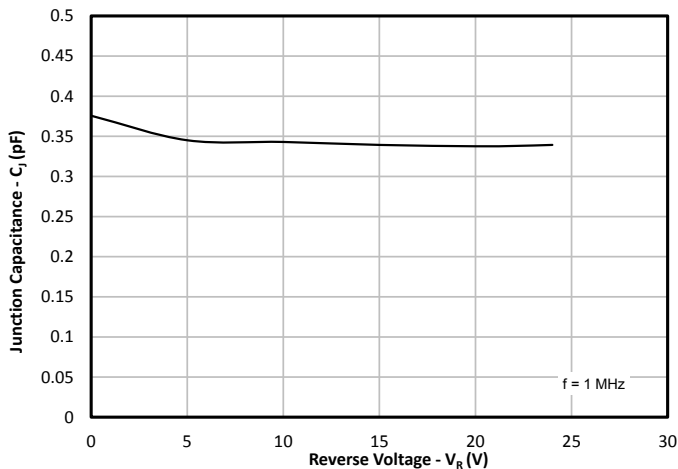

Typical Insertion Loss -S21

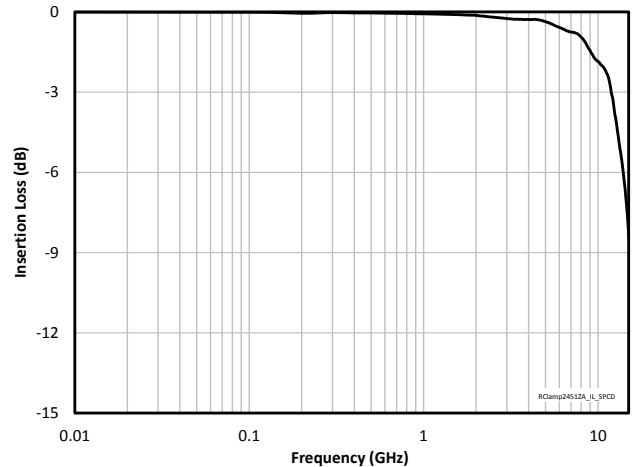

Application Information

ESD Protection of NFC Interfaces

The Near Field Communication (NFC) antenna is usually connected to the NFC controller IC via contact points on the phone. These contact points are user accessible and therefore may be subjected to ESD strikes. External protection (TVS) devices should be placed between the antenna and the NFC chip interface. The working voltage of the TVS should be high enough as not to clip the NFC signal. Additionally, the capacitance of the device should be minimized in

order to avoid harmonic distortion of the RF signal. RClamp2451ZA meets these requirements and also features extremely low dynamic resistance (<0.2 Ohms) resulting in low ESD clamping voltage. The low dynamic resistance also helps insure protection for Schottky diodes that may be used in the NFC circuit. RClamp2451ZA is designed to work on NFC circuits with AC signals as high as 24V. An example protection circuit using RClamp2451ZA is shown below in Figure 1.

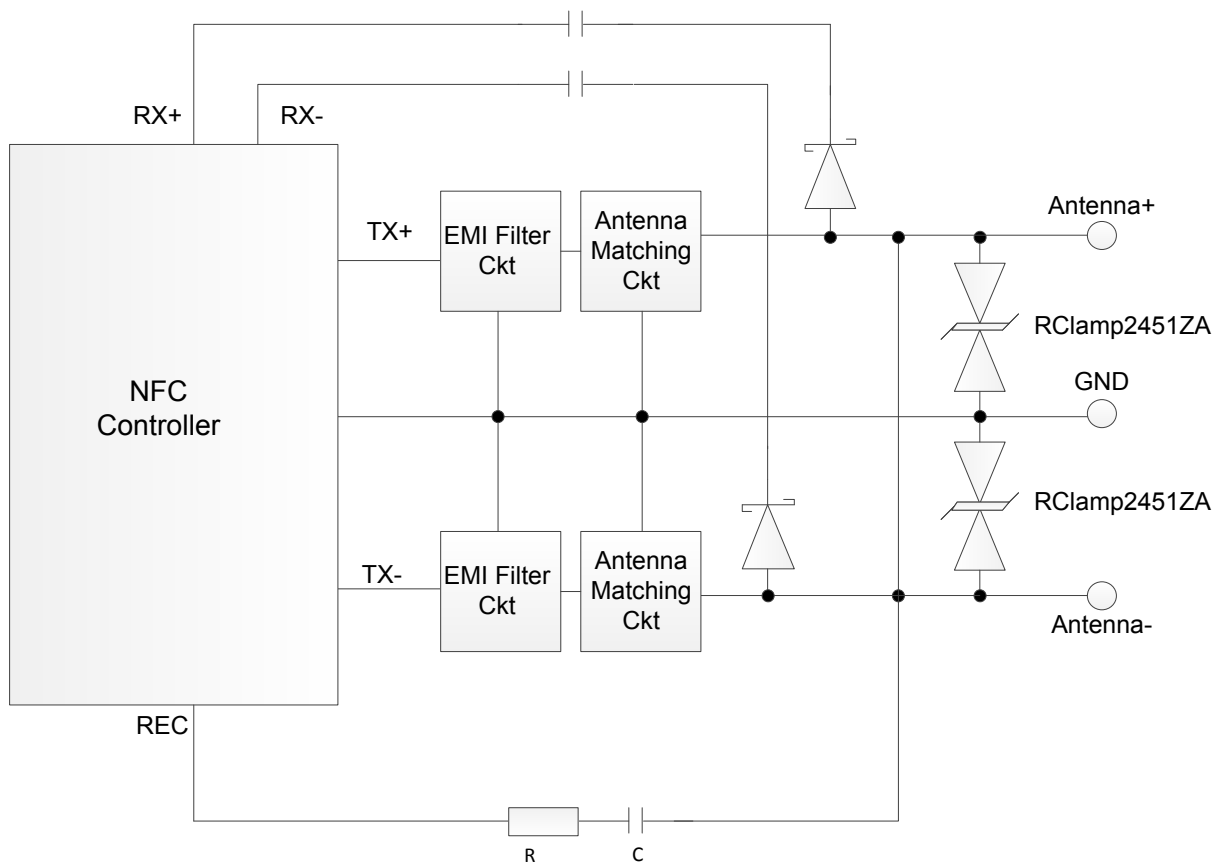

Figure 1 - NFC Protection Example

Application Information

Assembly Guidelines

The small size of this device means that some care must be taken during the mounting process to insure reliable solder joints. The figure at the right details Semtech's recommended mounting pattern. Recommended assembly guidelines are shown in Table 1. Note that these are only recommendations and should serve only as a starting point for design since there are many factors that affect the assembly process. Exact manufacturing parameters will require some experimentation to get the desired solder application.

Solder Stencil

Stencil design is one of the key factors which will determine the volume of solder paste which is deposited onto the land pad. The area ratio of the stencil aperture will determine how well the stencil will print. The area ratio takes into account the aperture shape, aperture size, and stencil thickness. A minimum area ratio of 0.66 is preferred for the subject package. The area ratio of a rectangular aperture is given as:

$$\text{Area Ratio} = (L * W) / (2 * (L + W) * T)$$

Where:

L = Aperture Length

W = Aperture Width

T = Stencil Thickness

Semtech recommends a stencil with square aperture and rounded corners for consistent solder release. The stencil should be laser cut with electropolished finish. A stencil thickness of 0.075mm (0.003") is recommended. A 0.100mm (0.004") stencil may be used, however the stencil opening may need to be increased slightly to achieve the desired area ratio to ensure proper solder coverage on the pad.

Recommended Mounting Pattern

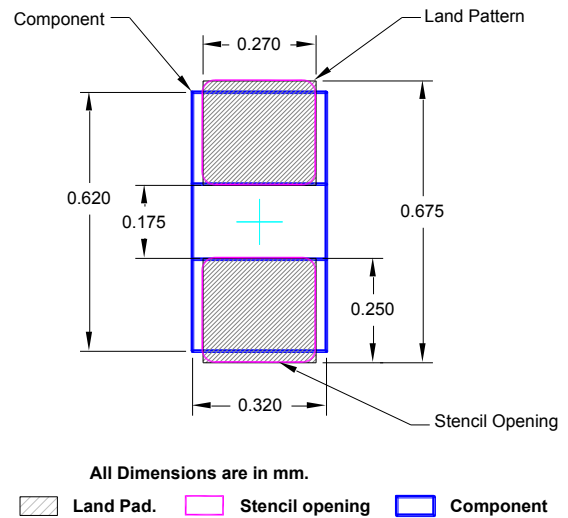
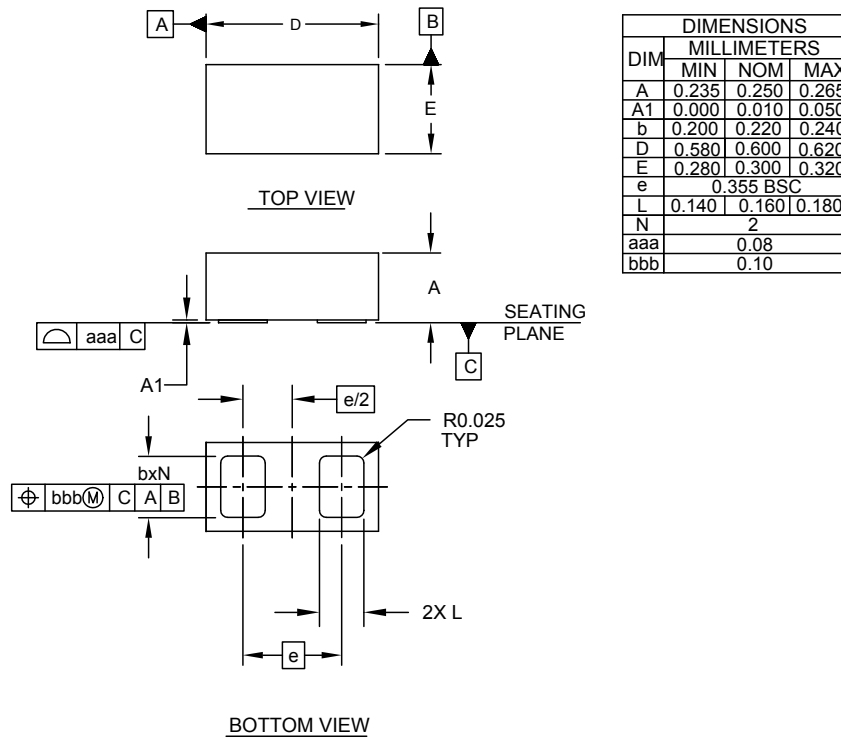

Table 1 - Assembly Guidelines

| Assembly Parameter | Recommendation |
|--------------------------|--------------------------------------|
| Solder Stencil Design | Laser Cut, Electro-Polished |
| Aperture Shape | Rectangular with Rounded Corners |
| Solder Stencil Thickness | 0.075mm (0.003") or 0.100mm (0.004") |
| Solder Paste Type | Type 4 Size Sphere or Smaller |
| Solder Reflow Profile | Per JEDEC J-STD-020 |
| PCB Solder Pad Design | Solder Mask Defined |
| PCB Pad Finish | OSP or NiAu |

Outline Drawing - SLP0603P2X3F



NOTES:
1. CONTROLLING DIMENSIONS ARE IN MILLIMETERS (ANGLES IN DEGREES).

Land Pattern - SLP0603P2X3F

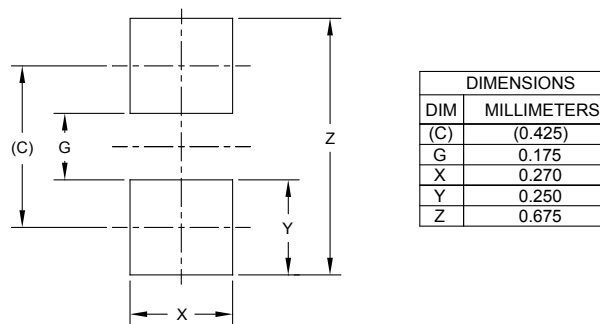

NOTES:
1. CONTROLLING DIMENSIONS ARE IN MILLIMETERS (ANGLES IN DEGREES).
2. THIS LAND PATTERN IS FOR REFERENCE PURPOSES ONLY. CONSULT YOUR MANUFACTURING GROUP TO ENSURE YOUR COMPANY'S MANUFACTURING GUIDELINES ARE MET.

Marking Code

e

Notes: Device is electrically symmetrical.

Tape and Reel Specification

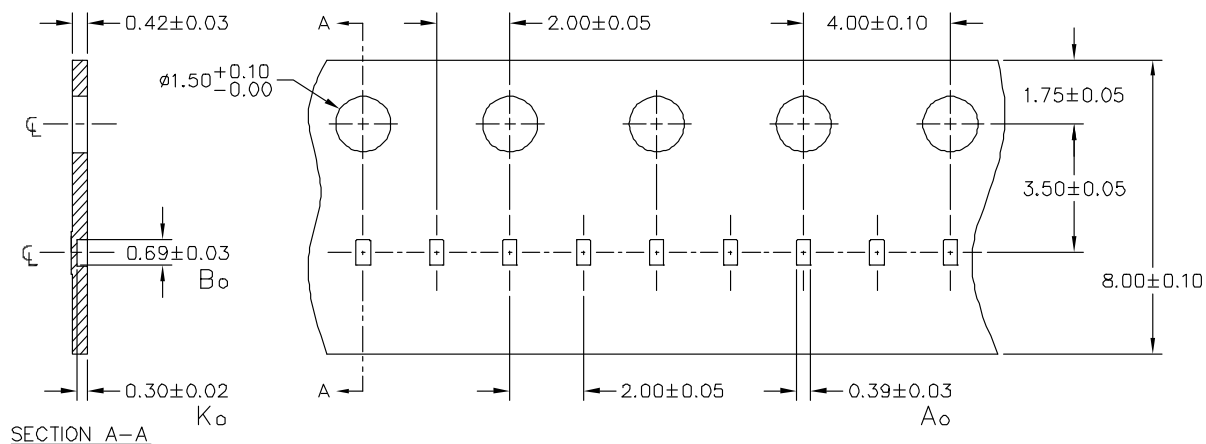

NOTES: ALL DIMENSIONS IN MILLIMETERS UNLESS OTHERWISE SPECIFIED.

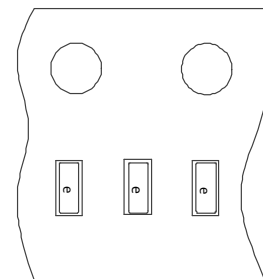

Ordering Information

| Part Number | Qty per Reel | Reel Size |
|--|--------------|-----------|
| RClamp2451ZATFT | 15,000 | 7" |
| RailClamp and RClamp are registered trademarks of Semtech Corporation. | | |



IMPORTANT NOTICE

Information relating to this product and the application or design described herein is believed to be reliable, however such information is provided as a guide only and Semtech assumes no liability for any errors in this document, or for the application or design described herein. Semtech reserves the right to make changes to the product or this document at any time without notice. Buyers should obtain the latest relevant information before placing orders and should verify that such information is current and complete. Semtech warrants performance of its products to the specifications applicable at the time of sale, and all sales are made in accordance with Semtech's standard terms and conditions of sale.

SEMTECH PRODUCTS ARE NOT DESIGNED, INTENDED, AUTHORIZED OR WARRANTED TO BE SUITABLE FOR USE IN LIFE-SUPPORT APPLICATIONS, DEVICES OR SYSTEMS, OR IN NUCLEAR APPLICATIONS IN WHICH THE FAILURE COULD BE REASONABLY EXPECTED TO RESULT IN PERSONAL INJURY, LOSS OF LIFE OR SEVERE PROPERTY OR ENVIRONMENTAL DAMAGE. INCLUSION OF SEMTECH PRODUCTS IN SUCH APPLICATIONS IS UNDERSTOOD TO BE UNDERTAKEN SOLELY AT THE CUSTOMER'S OWN RISK. Should a customer purchase or use Semtech products for any such unauthorized application, the customer shall indemnify and hold Semtech and its officers, employees, subsidiaries, affiliates, and distributors harmless against all claims, costs damages and attorney fees which could arise.

The Semtech name and logo are registered trademarks of the Semtech Corporation. All other trademarks and trade names mentioned may be marks and names of Semtech or their respective companies. Semtech reserves the right to make changes to, or discontinue any products described in this document without further notice. Semtech makes no warranty, representation or guarantee, express or implied, regarding the suitability of its products for any particular purpose. All rights reserved.

© Semtech 2015

Contact Information

Semtech Corporation
200 Flynn Road, Camarillo, CA 93012
Phone: (805) 498-2111, Fax: (805) 498-3804
www.semtech.com