

THIS DRAWING IS UNPUBLISHED. RELEASED FOR PUBLICATION
 © COPYRIGHT - BY TYCO ELECTRONICS CORPORATION. ALL RIGHTS RESERVED.

LOC	DIST	REVISIONS			
P	LTR	DESCRIPTION	DATE	DWN	APVD
H	-	A	DRAWING RELEASED PER ECR-11-017294	22AUG2011	JvdH TdB

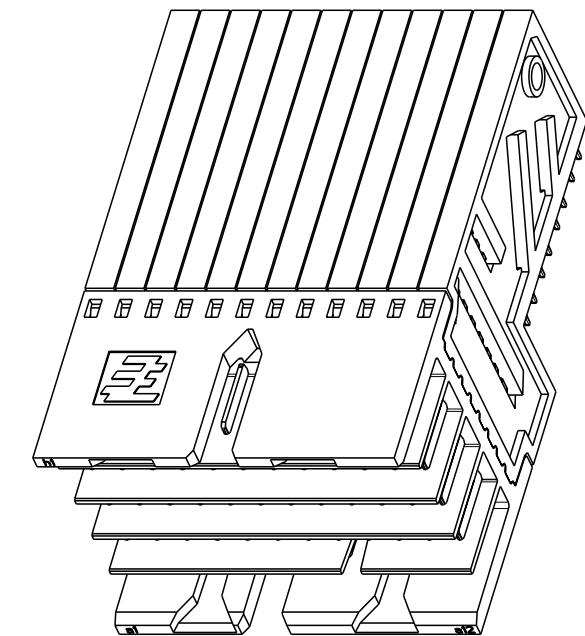

SCALE 3:1

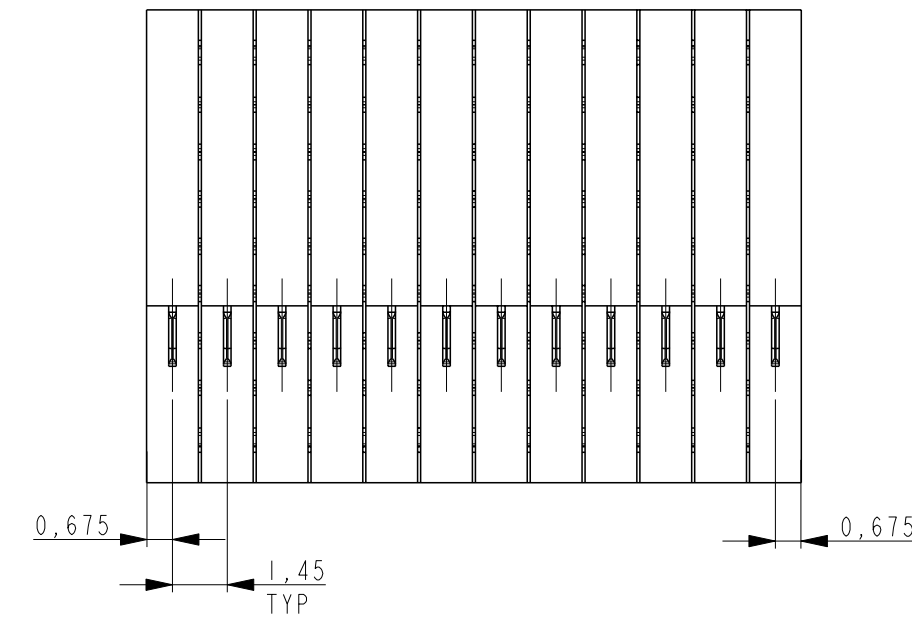
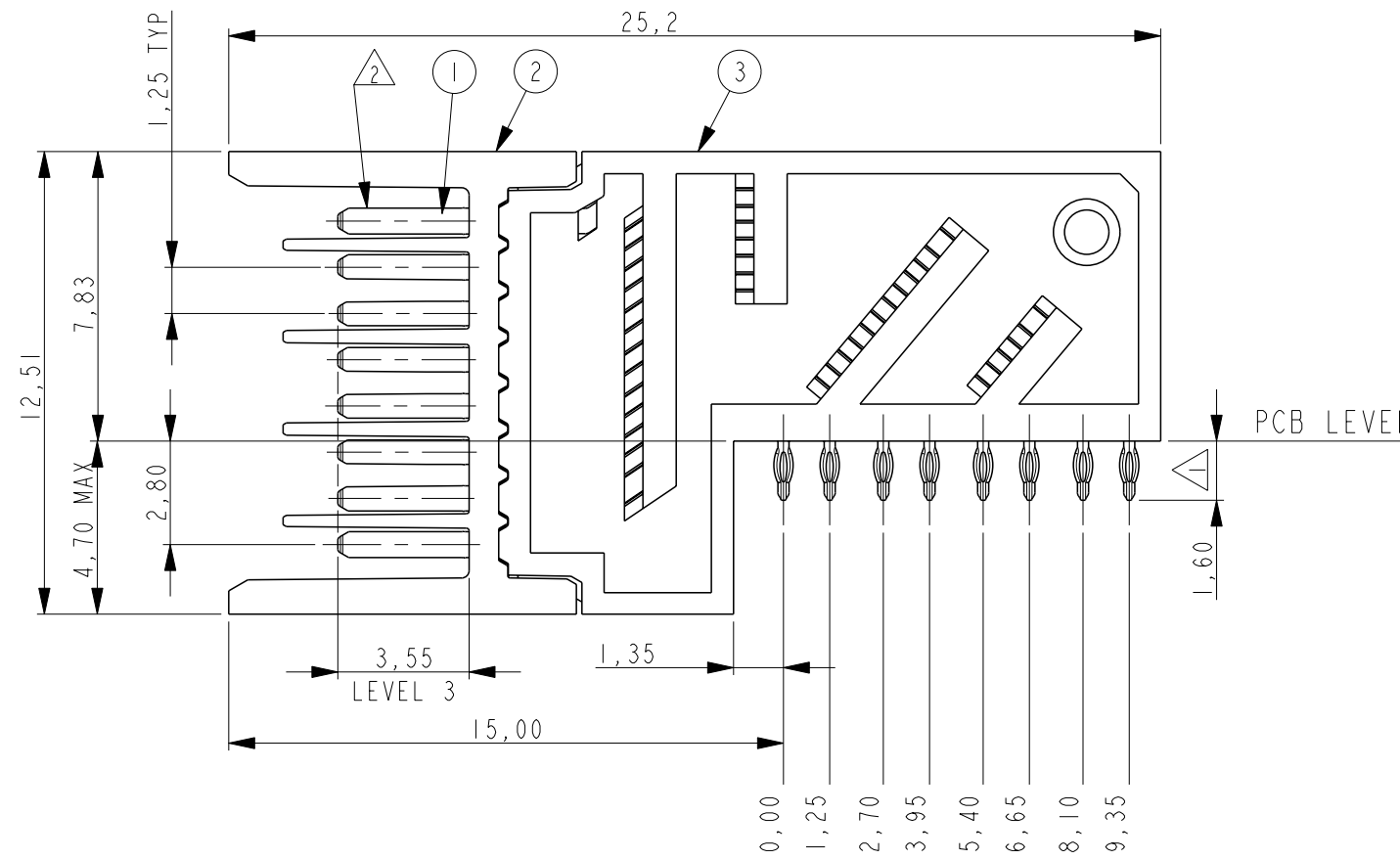
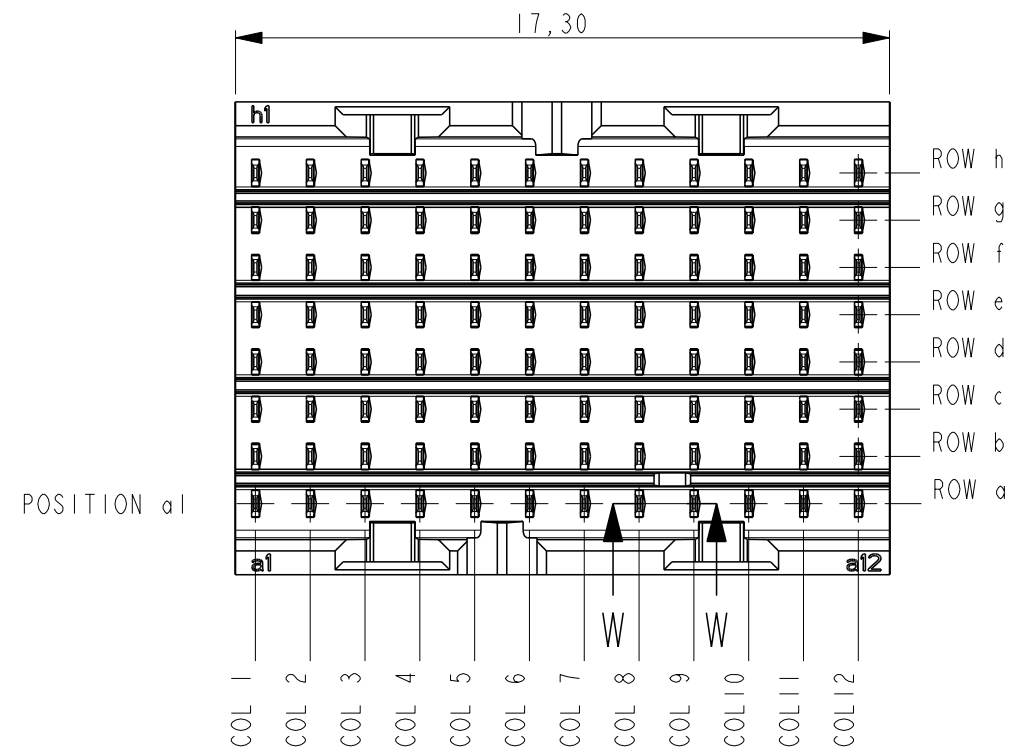
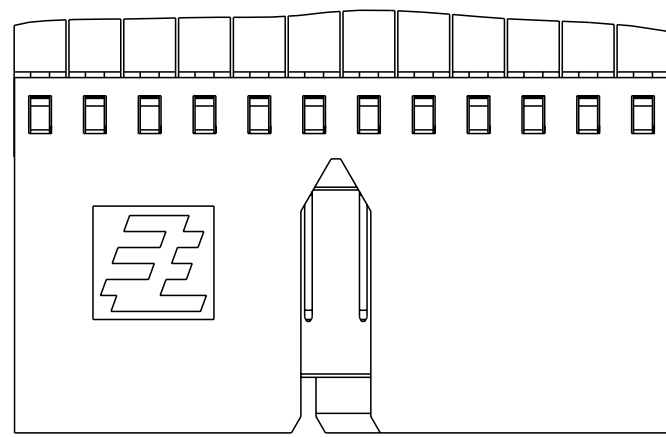
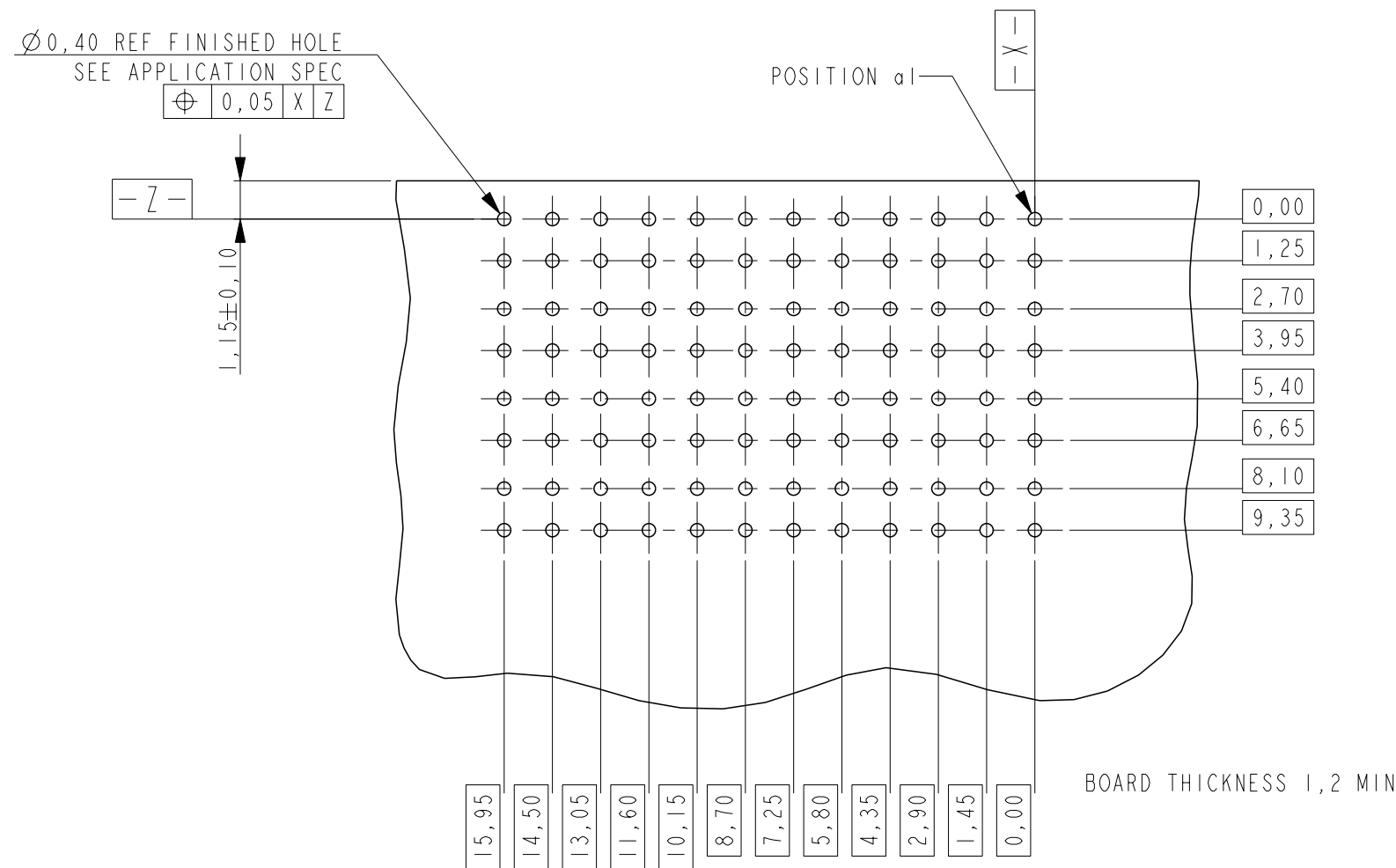
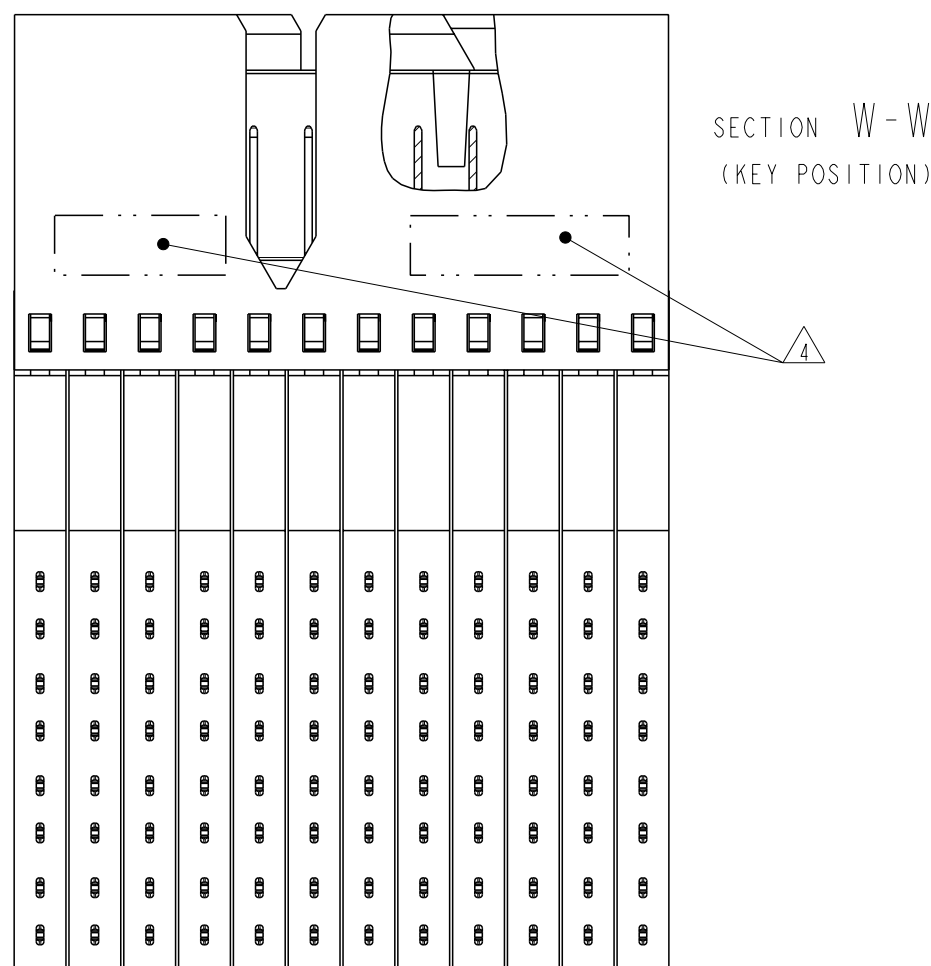

PRODUCT HAS NOT COMPLETED QUALIFICATION TESTING

NOTES:

- △ PLATING: 0,5µm MIN. TIN OVER NICKEL.
- △ PLATING:

PARTNUMBER	PERFORMANCE LEVEL
2042139-1	PERFORMANCE LEVEL 1: CONNECTOR TESTED AND QUALIFIED AGAINST TELCORDIA GR-1217-CORE QUALITY LEVEL 111: UNCONTROLLED ENVIRONMENT APPLICATIONS. SEE PRODUCT SPEC 108-19353
2042139-2	PERFORMANCE LEVEL 2: CONFORMS TO ALL TESTING ACCORDING PRODUCT SPEC 108-19320, -250 MATING CYCLES, 4 DAYS MIXED GAS TEST PER IEC 60068-2-60 METHOD 1

- 3 CONSULT APPLICATION SPEC OR CONTACT TE CONNECTIVITY FOR PERMISSIBLE CONTACT ASSIGNMENTS.
- △ CONNECTOR MARKED WITH PARTNUMBER AND DATE CODE.
- 5 FOR PC-BOARD ROUTING RECOMMENDATIONS SEE SPEC 114-19140

RECOMMENDED PCB LAYOUT (COMPONENT SIDE SHOWN)

THIS DRAWING IS A CONTROLLED DOCUMENT.		DWN RA 15-Apr-09
DIMENSIONS: mm		CHK RA 15-Apr-09
TOLERANCES UNLESS OTHERWISE SPECIFIED:		APVD -
0 PLC	±	PRODUCT SPEC
1 PLC	±	SEE NOTE △
2 PLC	±	APPLICATION SPEC
3 PLC	±	114-19106
4 PLC	±	WEIGHT -
ANGLES	±	CUSTOMER DRAWING
FINISH	±	

3	OVERMOLD	PBT 20% GF GREY
2	HOUSING	LCP 30% GF NATURAL
1	CONTACT	COPPER ALLOY
ITEM NO.	DESCRIPTION	MATERIAL
STE TE Connectivity		
NAME RIGHT ANGLE MALE CONNECTOR Z-PACK Slim UHD Common Speed		
SIZE	CAGE CODE	DRAWING NO
A2	00779	2042139
RESTRICTED TO	SCALE	SHEET
-	5:1	1 OF 1
REV		A