

ZL2102DEMO1Z Demonstration Board Data Sheet

Description

The ZL2102DEMO1Z is an innovative power conversion and management IC that combines an integrated synchronous step-down DC/DC converter with key power and fault management functions in small package, resulting in a flexible and integrated solution. The ZL2102DEMO1Z platform allows quick evaluation of the highly configurable ZL2102DEMO1Z's performance and features in either stand-alone mode or via the SMBus™ interface using Intersil's PowerNavigator GUI software.

Specifications

This board has been configured and optimized for the following operating conditions:

- $V_{IN} = 12V$
- $V_{OUT} = 3.3V$
- $I_{MAX} = 6A$
- $f_{SW} = 600kHz$
- Peak efficiency: >85% at 50% load
- Output ripple: <0.5% at 6A
- Dynamic response: 3.5% (3A to 5A and 5A to 3A steps, $di/dt = 2.5A/\mu s$)
- Board temperature: +25°C

Key Board Features

- Small, compact design
- SMBus™ control interface
- V_{IN} range of 7.5V to 14V
- V_{OUT} adjustable from 0.6 V to 3.6 V
- Convenient power connection
- Onboard enable switch
- Power-good indicator
- Interconnectivity with other intersil demo boards

References

[FN8440 "ZL2102" Data Sheet.](#)

Ordering Information

PART NUMBER	DESCRIPTION
ZL2102DEMO1Z	ZL2102 Evaluation Kit, one channel (EVB, USB Adapter, Cable, Software)

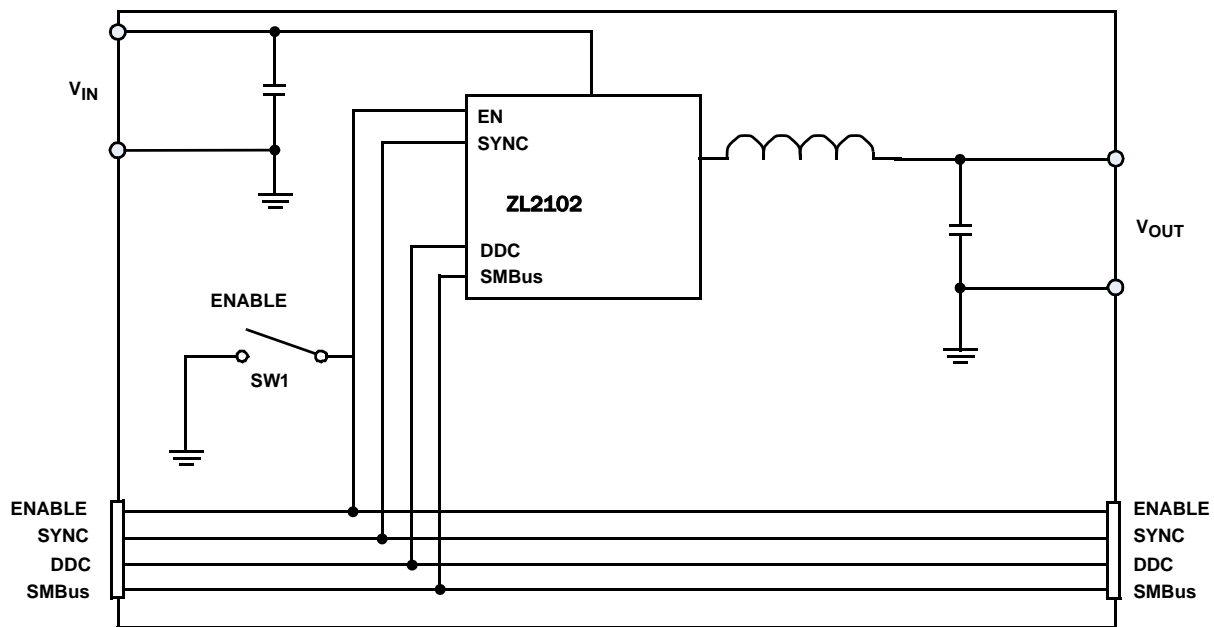

FIGURE 1. ZL2102DEMO1Z BLOCK DIAGRAM

Functional Description

The ZL2102DEMO1Z Demo Board provides a simple platform to demonstrate the features of the ZL2102. The ZL2102DEMO1Z has a functionally optimized ZL2102 circuit layout that allows efficient operation up to the maximum output current. Power and load connections are provided through plug-in sockets. Standalone operation is achieved using a combination of pin-strap settings and stored settings. The pin-strap setting details are described in the ZL2102 data sheet. The stored settings are listed in “Default Configuration Settings” on page 11.

The ZL2102DEMO1Z Demonstration Board is shown in Figure 2 and Figure 3. The hardware enable function is controlled by a toggle switch. The power-good (PG) LED indicates that V_{OUT} is regulating. The right angle headers at opposite ends of the board are for connecting a USB to SMBus control board or for daisy chaining of multiple Intersil evaluation boards.

Connecting multiple Intersil Zilker Lab boards allows the user to setup many shared features such as clock synchronization, controlled sequencing, phase spreading, and fault spreading within Intersil’s Power Navigator software as part of a single power project. The ZL2102DEMO1Z Circuit Schematic (Figure 9) shows the schematic, bill of materials, and PCB layers for reference. Figures 10 through 13 show performance data taken using this hardware in its optimized configuration. The configuration settings that the hardware ships with are shown on Page 11.

Operating Range

By default, the ZL2102DEMO1Z is configured for the operating conditions shown in “USB (PMBus) Operation”. The board can also support a wider operating range, and modifying the operating conditions will change the performance results.

The board V_{IN} range is 7.5V to 14V. The board V_{OUT} setting is fixed at 3.3V by pin strap setting, but the programmable range is 0.54V to 3.6V (including margin high/low). The output voltage can be changed by using the $V_{OUT_COMMAND}$ PMBus command. The board I_{OUT} range is 0 to 6A. For continuous operation at 6A, airflow across the board may be needed.

The switching frequency (f_{SW}) is set to 600kHz by PMBus command, but the f_{SW} setting can be changed by using the $FREQUENCY_SWITCH$ PMBus command (while the device is disabled). The f_{SW} range is 200kHz to 1MHz.

PCB Layout Notes

The ZL2102DEMO1Z PCB layout has been optimized for electrical and thermal performance.

The following key features are:

- The large 5x5 via pattern under the ZL2102 is connected to a large copper plane for effective thermal dissipation.
- SGND and power GND are isolated. The ZL2102’s thermal pad is connected to the isolated SGND plane which is then reconnected to the power GND plane at pin 14 of ZL2102 on inner layer 1.
- The VSEN pin is Kelvin connected to C2 through inner layer 2 for improved noise performance.

Quick Start Guide

Stand Alone Operation

1. Ensure that the board is properly connected to the supply and loads prior to applying any power.
2. Connect the input supply to VIN and GND.
3. Connect the load to VOUT and GND.
4. Set ENABLE switch to “DISABLE”.
5. Turn input power supply ON.
6. Set ENABLE switch to “ENABLE”.
7. Test ZL2102 operation.

USB (PMBus) Operation

1. Follow step 1 through 5 of Stand Alone Operation.
2. Download PowerNavigator software from the Intersil website and install.
3. Connect USB-to-SMBus interface board to J2 of ZL2102DEMO1Z.
4. Set voltage to desired value in GUI.
5. Set ENABLE switch on EVB to “ENABLE”.
6. Monitor and configure EVB using PMBus commands in the evaluation software.
7. Test ZL2102 operation using the evaluation software.

ZL2102DEMO1Z Evaluation Board

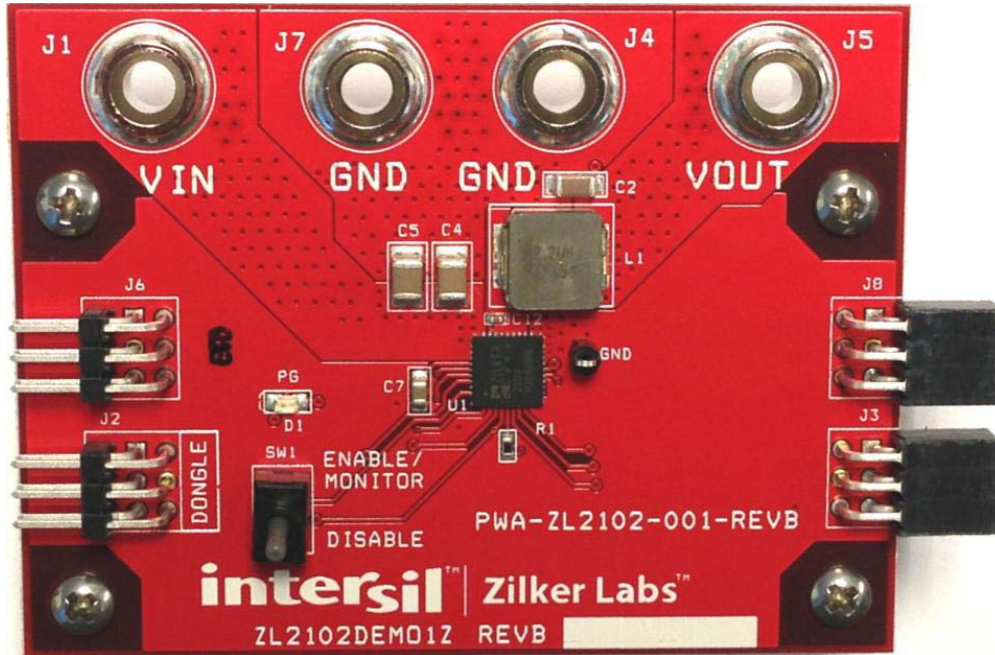

FIGURE 2. TOP SIDE

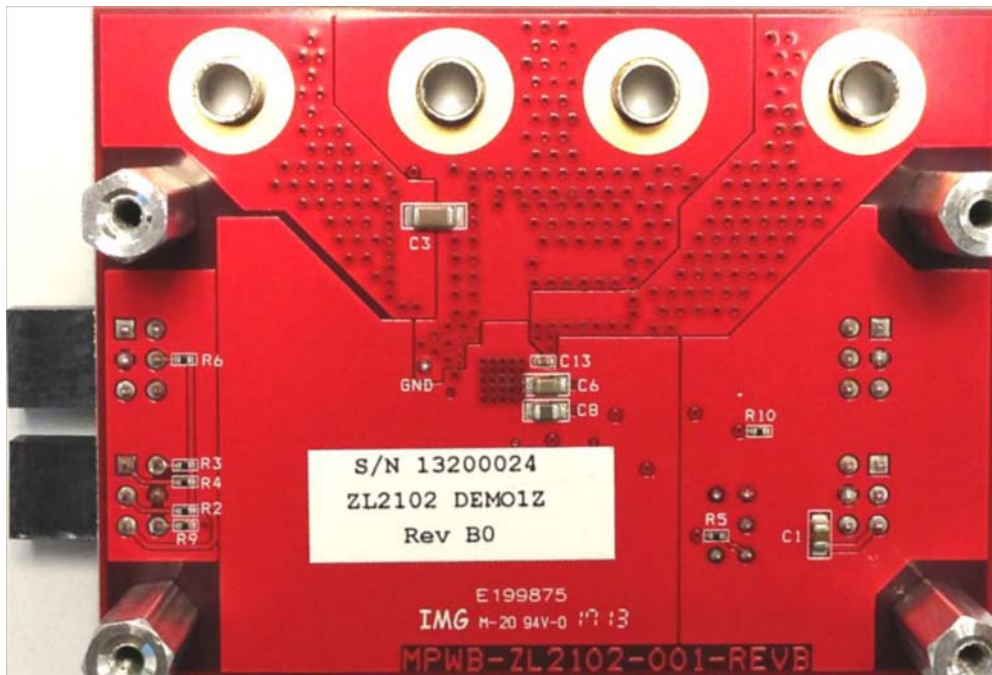

FIGURE 3. BOTTOM SIDE

ZL2102DEMO1Z Circuit Schematic

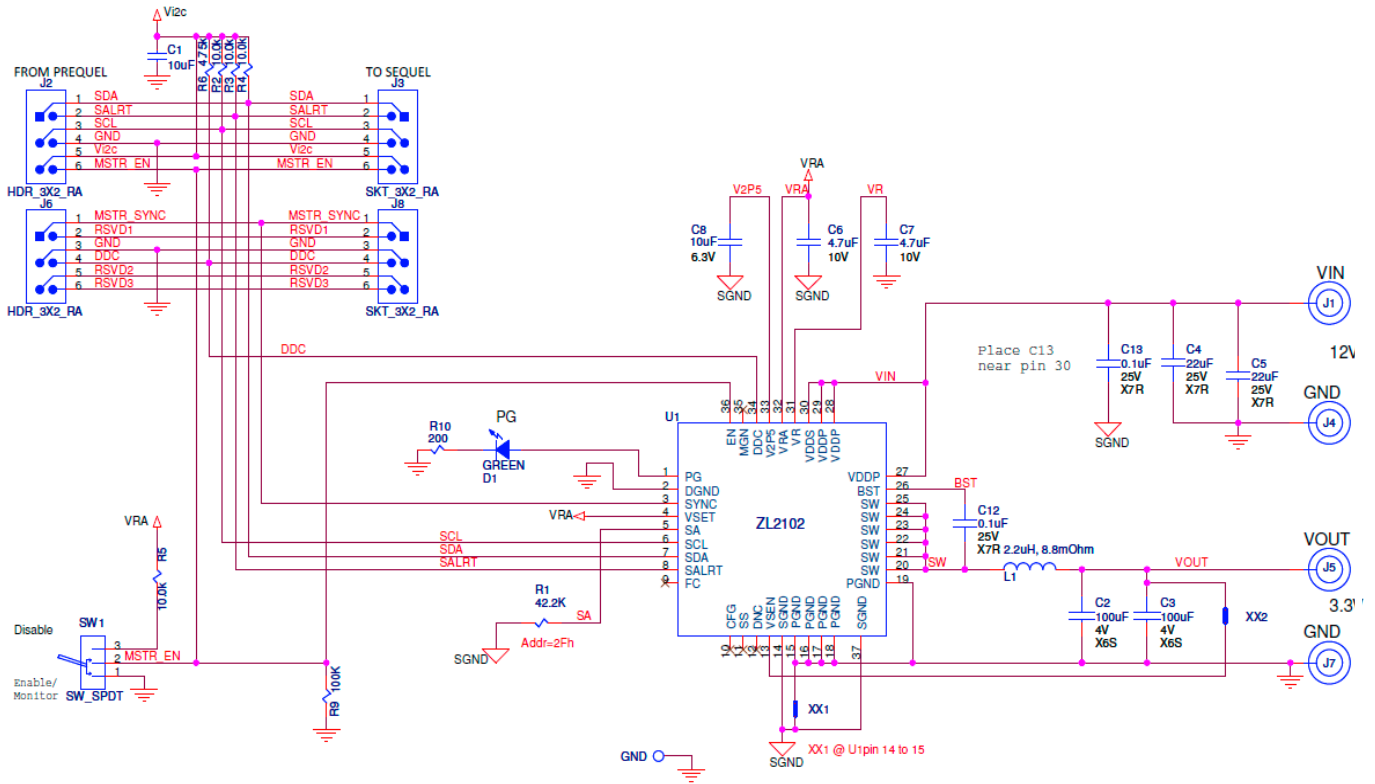

TABLE 1. BILL OF MATERIALS

ZL2102DEMO1Z CIRCUIT RSCH-ZL2102-001 Revision: B									
ITEM	QTY	REFERENCE DESIGNATOR	VALUE	TOL (%)	RATING	TYPE	PCB FOOTPRINT	MANUFACTURER	PART NUMBER
1	1	C1	10µF	10	10V	X7R	SM0805	Taiyo Yuden	LMK212B7106KG-TD
2	2	C2, C3	100µF	20	4V	X6S	SM1206	TDK Corporation	C3216X6S0G107M
3	2	C4, C5	22µF	20	25V	X7R	SM1210	Taiyo Yuden	TMK325B7226MM-TR
4	2	C6, C7	4.7µF	20	10V	X5R	SM0805	PANASONIC-ECG	ECJ-GVB1A475M
5	1	C8	10µF	20	6.3V	X5R	SM0805	MURATA	GRM21BR60J106ME19L
6	2	C12, C13	0.1µF	10	25V	X7R	SM0402	TDK Corporation	C1005X7R1E104K
7	1	D1	GREEN		2V, 20mA	LED	SM0805	CHICAGO MINIATURE	CMD17-21VGC/TR8
8	4	J1, J4, J5, J7	JACK_BANANA			Banana Jack	JACK_KEYSTONE_575-4	Keystone	575-4
9	2	J2, J6	HDR_3X2_RA			RA	HDRM3DUALRA100X100	SAMTEC	TSW-103-08-T-D-RA
10	2	J3, J8	SKT_3X2_RA			RA	HDRF3DUALRA100X100	SAMTEC	SSQ-103-02-T-D-RA
11	1	L1	2.2µH, 8.8mΩ	20	14.5A		8.64mm x 8.18mm	Vishay Dale	IHLP3232DZER2R2M11
12	1	R1	42.2k	1	100mW	THK FILM	SM0603	PANASONIC-ECG	ERJ-3EKF4222V
13	4	R2, R3, R4, R5	10.0k	1	63mW	THK FILM	SM0402	YAGEO	RC0402FR-0710KL
14	1	R6	4.75k	1	100mW	THK FILM	SM0402	PANASONIC-ECG	ERJ-2RKF4751X
15	1	R9	100k	1	63mW	THK FILM	SM0402	Stackpole Electronics Inc	RMCF0402JT100K
16	1	R10	200	1	100mW	THK FILM	SM0402	Panasonic-ECG	ERJ-2RKF2000XR
17	1	SW1	SW_SPDT			PCB VERT	SW_TOG_ULTRAMIN_SPDT	NKK	G12AP
18	1	TP1	GND				TP_036H_SVAL2S		
19	1	U1	ZL2102				MLF36	INTERSIL	ZL2102ALAF
20	NS	XX1, XX2	TIEPT/10WIDE				TIEPT/10WIDE		
21	4	XX3, XX4, XX5, XX6	STANDOFF_#4-40.75LG				STANDOFF_4-40_NDH		
22	4	XX7, XX8, XX9, XX10	SCREW_#4-40x0.25"			PHL	SCREW_40-40	BUILDING FASTENERS	PMS4400025PH
23	1	XX11	PCB				BDOTLN3.0HX4.0L	INTERSIL	MPWB-ZL2102-001

Board Layout - 4 Layers

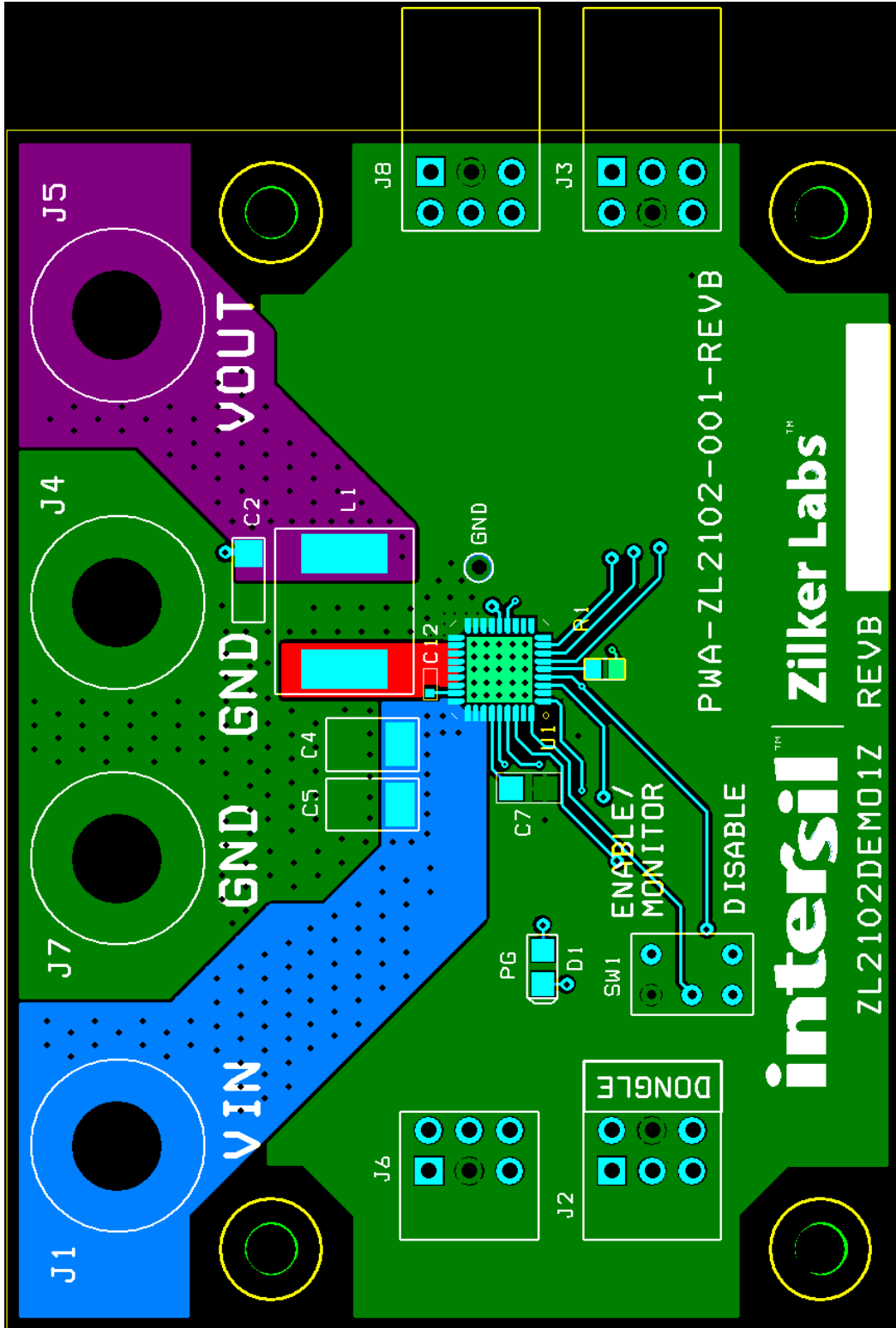

FIGURE 4. TOP LAYER

Board Layout - 4 Layers (Continued)

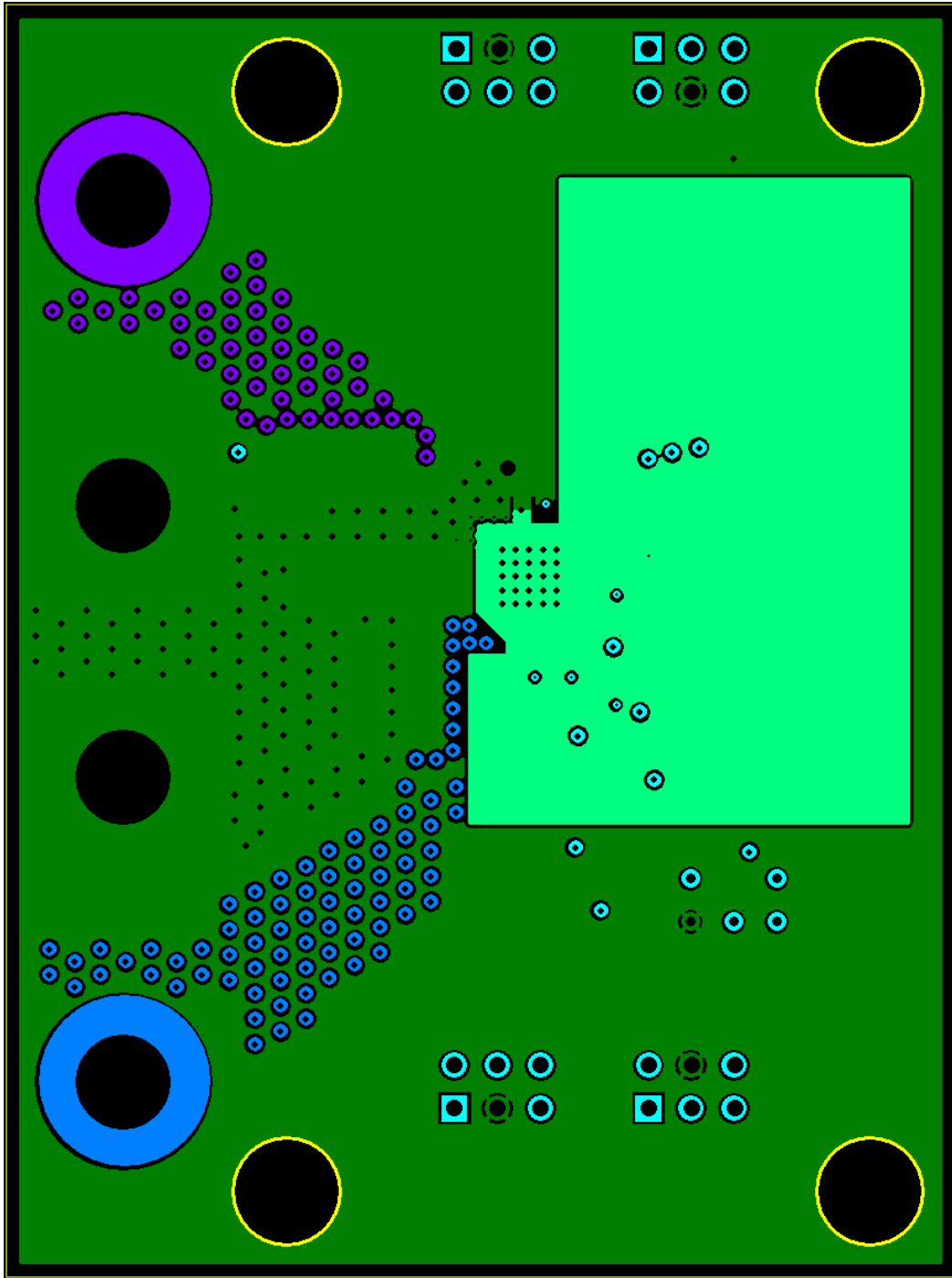

FIGURE 5. PCB - INNER LAYER 1 (VIEWED FROM TOP)

Board Layout - 4 Layers (Continued)

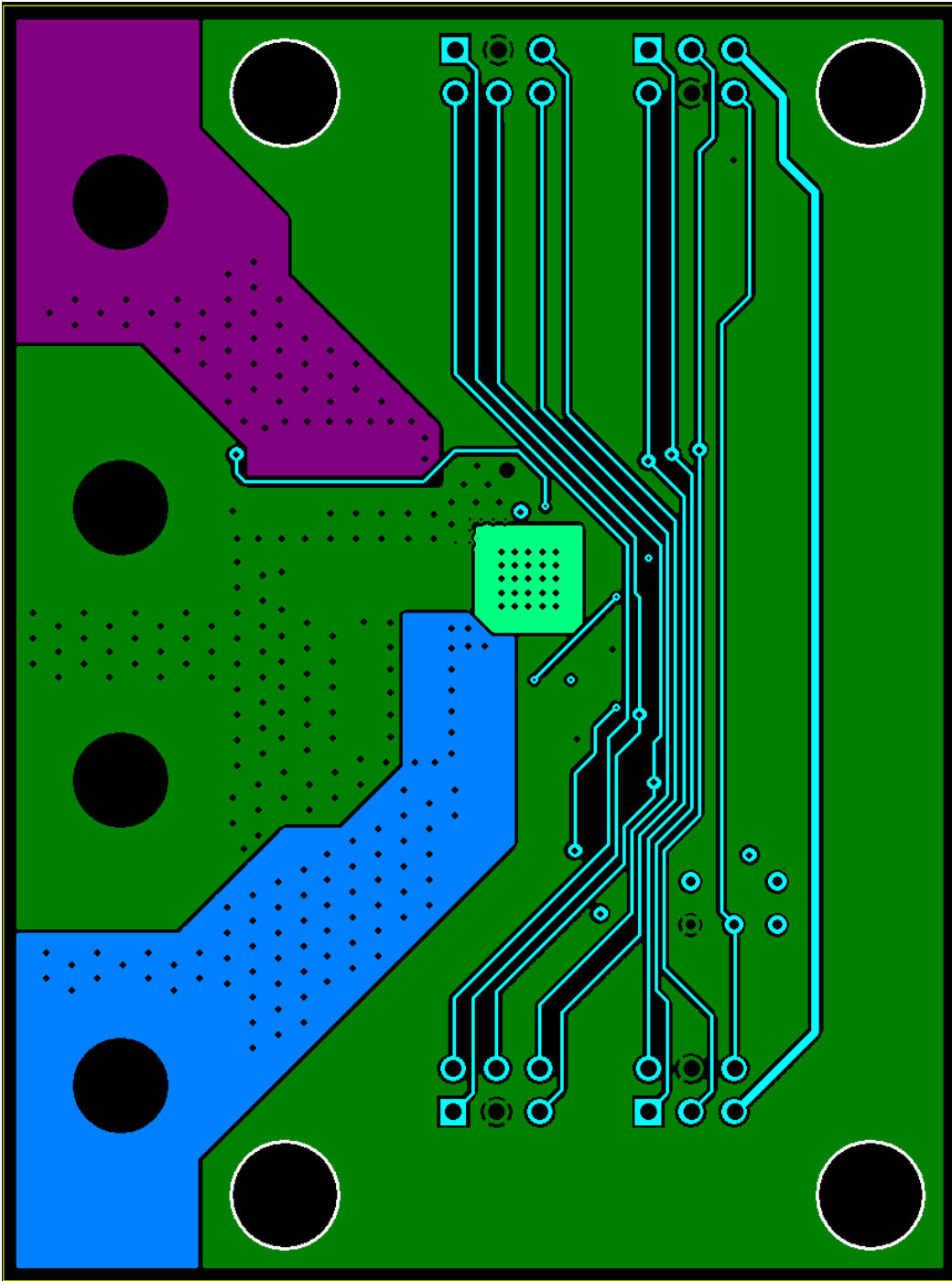

FIGURE 6. PCB - INNER LAYER 2 (VIEWED FROM TOP)

Board Layout - 4 Layers (Continued)

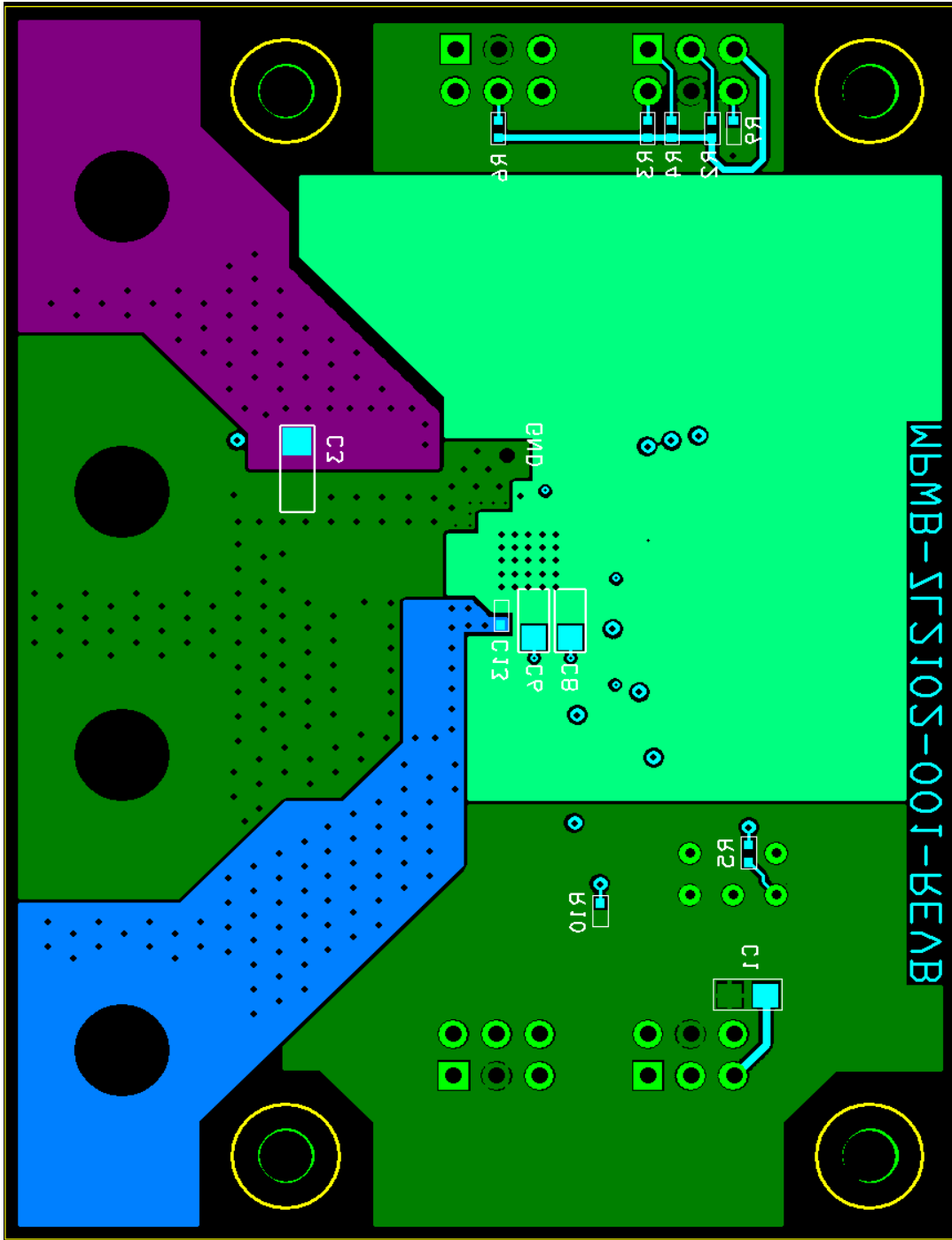

FIGURE 7. PCB - BOTTOM LAYER (VIEWED FROM TOP)

Application Note 1874

Typical Performance Curves

Unless noted: $V_{IN} = 12\text{ V}$, $V_{OUT} = 3.3\text{ V}$, $f_{SW} = 400\text{ kHz}$, $T_A = 25\text{ }^\circ\text{C}$

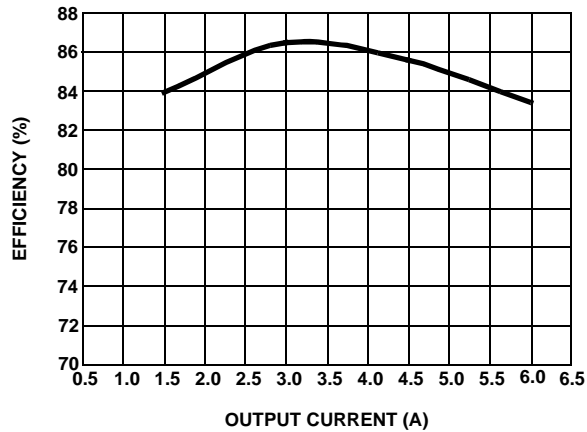

FIGURE 8. MEASURED EFFICIENCY $V_{IN} = 12\text{ V}$, $V_{OUT} = 3.3\text{ V}$

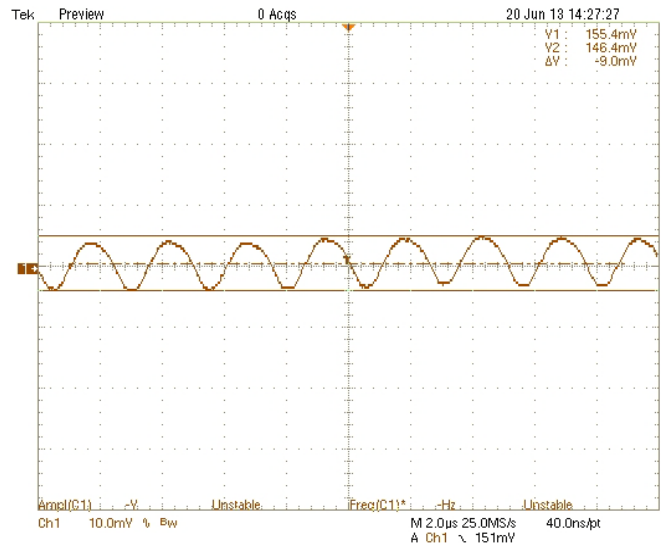

FIGURE 9. OUTPUT RIPPLE MEASURED ACROSS C3

Dynamic Response

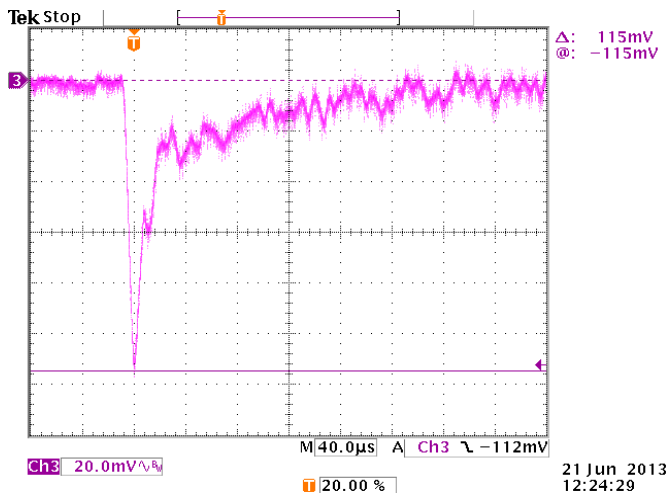

FIGURE 10. (3 - 5 A) LOAD STEP, $di/dt = 2.5\text{ A}/\mu\text{s}$

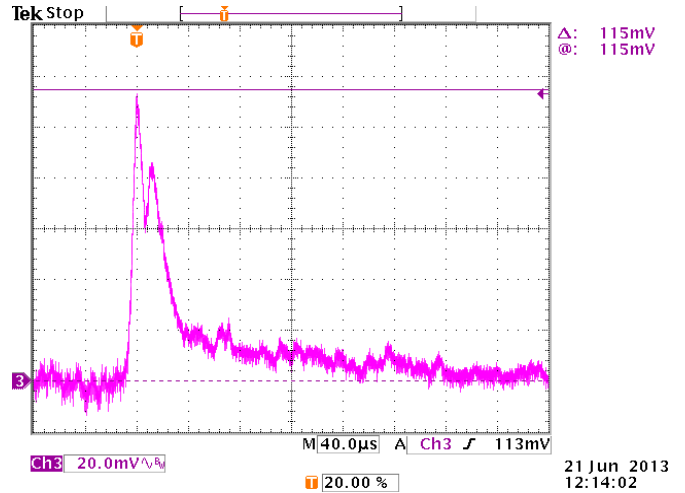

FIGURE 11. (5 - 3 A) LOAD STEP, $di/dt = 2.5\text{ A}/\mu\text{s}$

Dynamic Response (Continued)

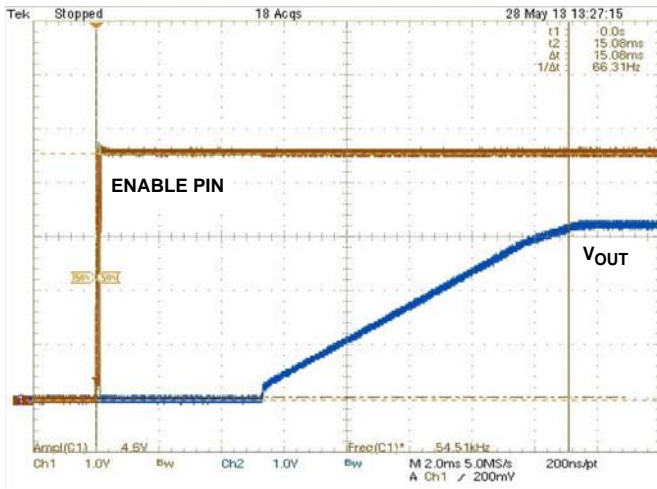

FIGURE 12. DEFAULT RAMP-UP TIME SETTING OF 5ms DELAY, 10ms RISE

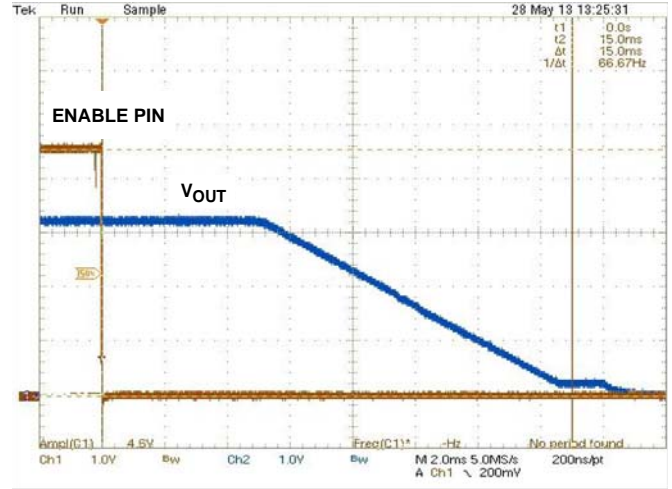

FIGURE 13. RAMP-DOWN TIME SETTING OF 5ms Delay, 10ms FALL

Default Configuration Settings

Most configuration settings for this design set by pin strap or are the factory defaults. The following configuration settings are loaded into the ZL2102DEM01Z for additional performance optimization.

- (Set PG pin to push-pull for demo board LED operation)
MFR_CONFIG: x4803

- (Set switching frequency to 600 kHz)
FREQUENCY_SWITCH: 0x0258

The following additional settings should be used for best transient performance:

- (Set switching frequency to 800 kHz)
FREQUENCY_SWITCH: 0x0320

- (Set Auto Comp for 100% gain)
AUTO_COMP_CONFIG: 0x99

Intersil Corporation reserves the right to make changes in circuit design, software and/or specifications at any time without notice. Accordingly, the reader is cautioned to verify that the Application Note or Technical Brief is current before proceeding.

For information regarding Intersil Corporation and its products, see www.intersil.com