

# MOS FET Relays

# G3VM-354C/C1/F/F1

## Analog-switching MOS FET Relay with DPST-NC Contacts. General-purpose models added.

- Switches minute analog signals.
- Switching AC and DC.
- General-purpose models (high ON resistance) added.
- RoHS Compliant.

### Application Examples

- Electronic automatic exchange systems
- Security systems
- Datacom (modem) systems
- FA systems and Measurement devices

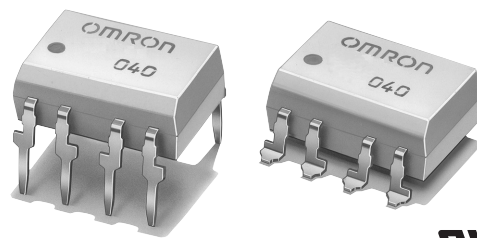

**Note:** The actual product is marked differently from the image shown here.

### List of Models

Contact form	Terminals	Load voltage (peak value)	Model	Number per stick	Number per tape	
DPST-NC	PCB terminals	350 VAC	G3VM-354C	50	---	
			G3VM-354C1			
			G3VM-354F			
			G3VM-354F1			
	Surface-mounting terminals		G3VM-354F(TR)	---		1,500
			G3VM-354F1(TR)			

### Dimensions

**Note:** All units are in millimeters unless otherwise indicated.

#### G3VM-354C/C1

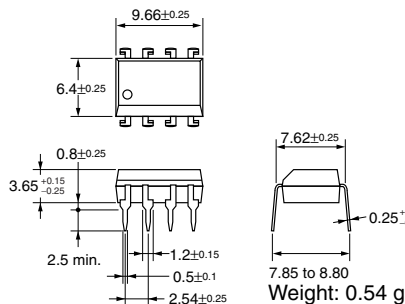
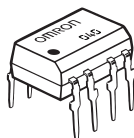

**Note:** The actual product is marked differently from the image shown here.

#### G3VM-354F/F1

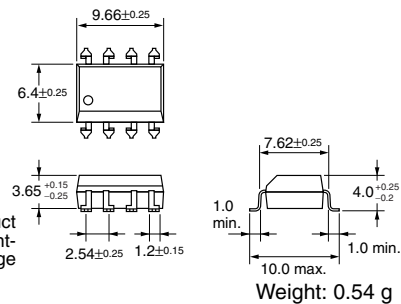
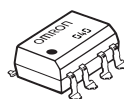

**Note:** The actual product is marked differently from the image shown here.

### Terminal Arrangement/Internal Connections (Top View)

#### G3VM-354C/C1

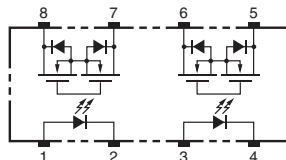

#### G3VM-354F/F1

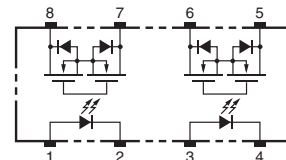

### PCB Dimensions (Bottom View)

#### G3VM-354C/C1

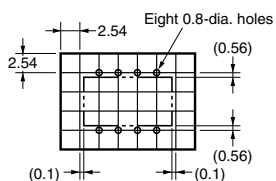

### Actual Mounting Pad Dimensions (Recommended Value, Top View)

#### G3VM-354F/F1

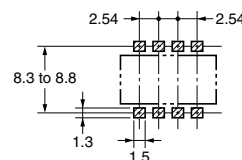

■ Absolute Maximum Ratings (Ta = 25°C)

Item		Symbol	Rating	Unit	Measurement conditions
Input	LED forward current	$I_F$	50	mA	
	Repetitive peak LED forward current	$I_{FP}$	1	A	100 $\mu$ s pulses, 100 pps
	LED forward current reduction rate	$\Delta I_F/^\circ\text{C}$	-0.5	mA/°C	Ta $\geq$ 25°C
	LED reverse voltage	$V_R$	5	V	
	Connection temperature	$T_j$	125	°C	
Output	Load voltage (AC peak/DC)	$V_{OFF}$	350	V	
	Continuous load current (AC peak/DC)	$I_O$	150 (100)	mA	
	ON current reduction rate	$\Delta I_{ON}/^\circ\text{C}$	-1.5 (-1)	mA/°C	Ta $\geq$ 25°C
	Connection temperature	$T_j$	125	°C	
Dielectric strength between input and output (See note 1.)		$V_{I-O}$	2,500	$V_{rms}$	AC for 1 min
Operating temperature		$T_a$	-40 to +85	°C	With no icing or condensation
Storage temperature		$T_{stg}$	-55 to +125	°C	With no icing or condensation
Soldering temperature (10 s)		---	260	°C	10 s

Note: 1. The dielectric strength between the input and output was checked by applying voltage between all pins as a group on the LED side and all pins as a group on the light-receiving side.

Values in parentheses are for the G3VM-354C1/F1

■ Electrical Characteristics (Ta = 25°C)

Item		Symbol	Minimum	Typical	Maximum	Unit	Measurement conditions
Input	LED forward voltage	$V_F$	1.0	1.15	1.3	V	$I_F = 10$ mA
	Reverse current	$I_R$	---	---	10	$\mu$ A	$V_R = 5$ V
	Capacity between terminals	$C_T$	---	30	---	pF	$V = 0, f = 1$ MHz
	Trigger LED forward current	$I_{FT}$	---	1	3	mA	$I_{OFF} = 10$ $\mu$ A
Output	Maximum resistance with output ON	$R_{ON}$	---	15 (30)	25 (50)	$\Omega$	$I_O = 150$ mA
	Current leakage when the relay is open	$I_{LEAK}$	---	0.0105 (0.003)	1.0	$\mu$ A	$I_F = 5$ mA, $V_{OFF} = 350$ V
	Capacity between terminals	$C_{OFF}$	---	85 (30)	---	pF	$V = 0, f = 1$ MHz, $I_F = 5$ mA
Capacity between I/O terminals		$C_{I-O}$	---	0.8	---	pF	$f = 1$ MHz, $V_s = 0$ V
Insulation resistance		$R_{I-O}$	1,000	---	---	M $\Omega$	$V_{I-O} = 500$ VDC, $R_{OH} \leq 60\%$
Turn-ON time		$t_{ON}$	---	0.1 (0.25)	1.0 (0.5)	ms	$I_F = 5$ mA, $R_L = 200$ $\Omega$ , $V_{DD} = 20$ V (See note 2.)
Turn-OFF time		$t_{OFF}$	---	1.0 (0.5)	3.0(0.1)	ms	

Values in parentheses are for the G3VM-354C1/F1

■ Recommended Operating Conditions

Use the G3VM under the following conditions so that the Relay will operate properly.

Item	Symbol	Minimum	Typical	Maximum	Unit
Load voltage (AC peak/DC)	$V_{DD}$	---	---	280	V
Operating LED forward current	$I_F$	5	---	25	mA
Continuous load current (AC peak/DC)	$I_O$	---	---	150 (100)	mA
Operating temperature	$T_a$	-20	---	65	°C

Values in parentheses are for the G3VM-354C1/F1

Note: 2. Turn-ON and Turn-OFF Times

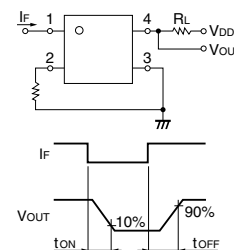

■ Engineering Data

G3VM-354C/F

LED forward current vs. Ambient temperature  
IF - Ta

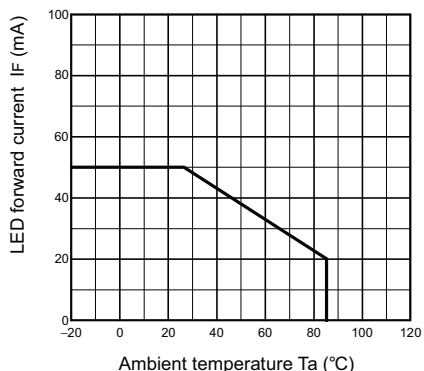

Continuous load current vs. Ambient temperature  
IO - Ta

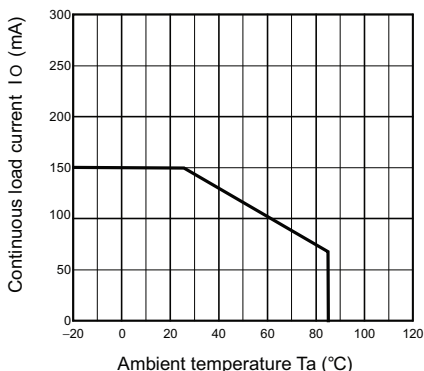

LED forward current vs. LED forward voltage  
IF - VF

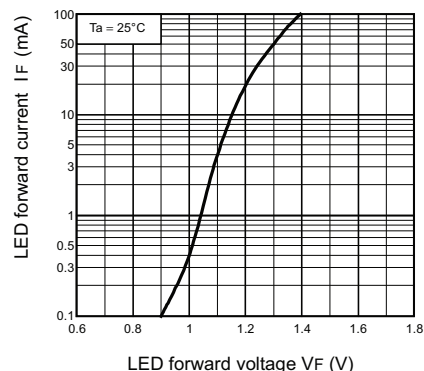

Continuous load current vs. On-state voltage  
IO - VON

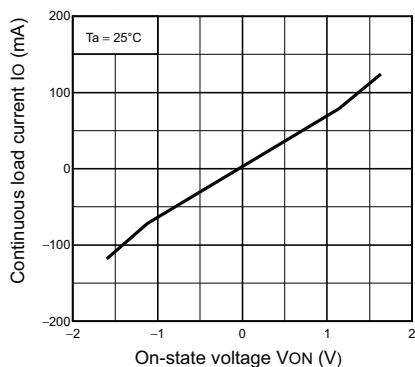

On-state resistance vs. Ambient temperature  
RON - Ta

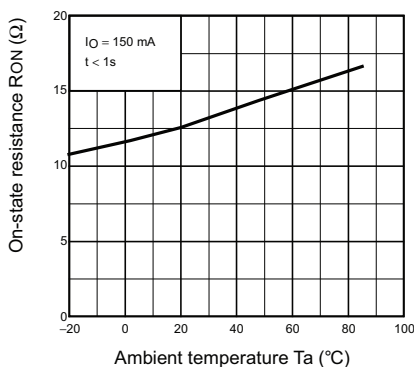

Trigger LED forward current vs. Ambient temperature  
IFC - Ta

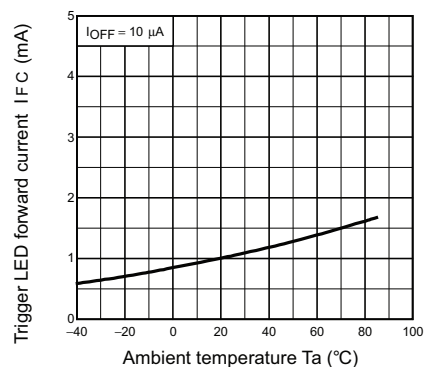

Turn ON, Turn OFF time vs. LED forward current  
tON, tOFF - IF

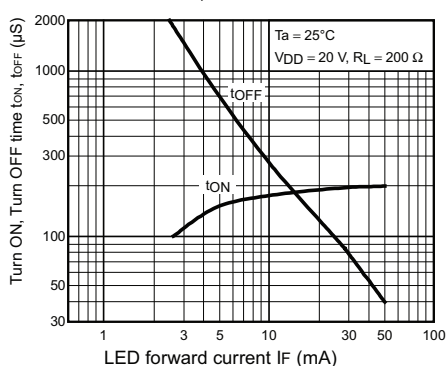

Turn ON, Turn OFF time vs. Ambient temperature  
tON, tOFF - Ta

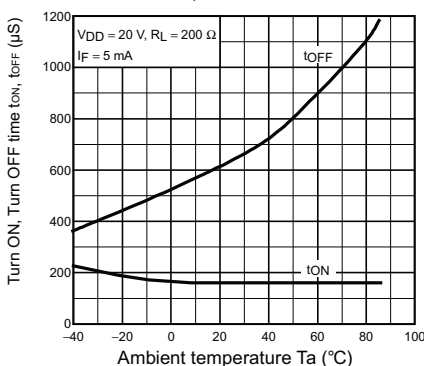

Current leakage vs. Ambient temperature  
ILEAK - Ta

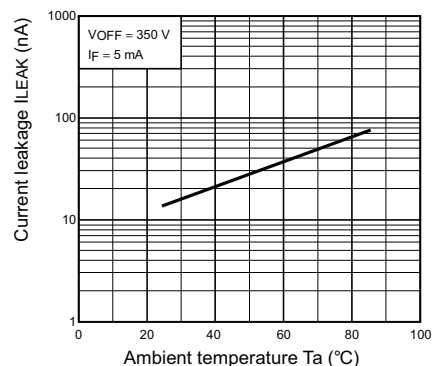

■ Engineering Data

G3VM-354C1/F1

LED forward current vs. Ambient temperature  
IF - Ta

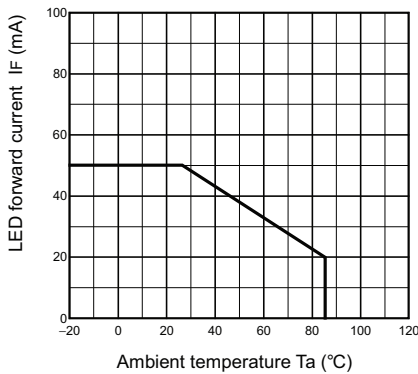

Continuous load current vs. Ambient temperature  
IO - Ta

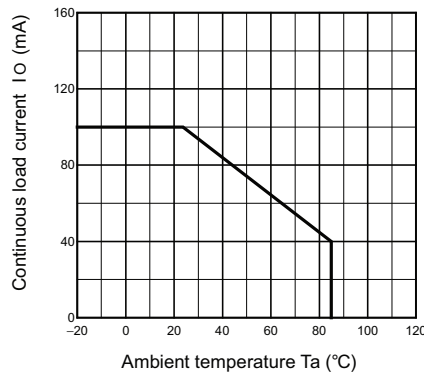

LED forward current vs. LED forward voltage  
IF - VF

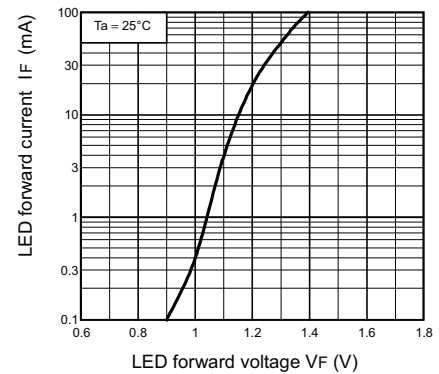

Continuous load current vs. On-state voltage  
IO - VON

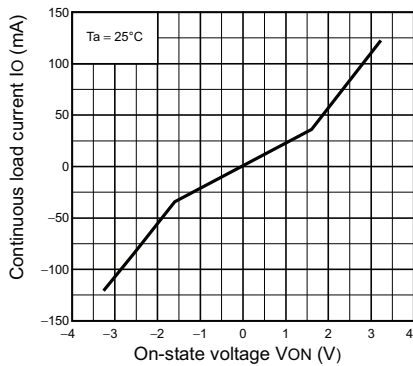

On-state resistance vs. Ambient temperature  
RON - Ta

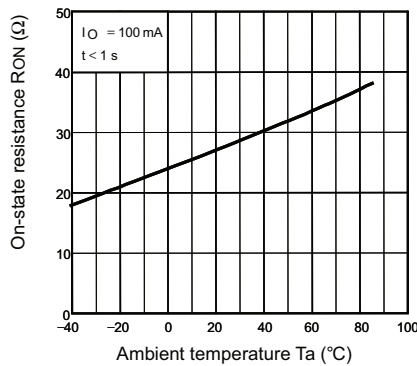

Trigger LED forward current vs. Ambient temperature  
IFC - Ta

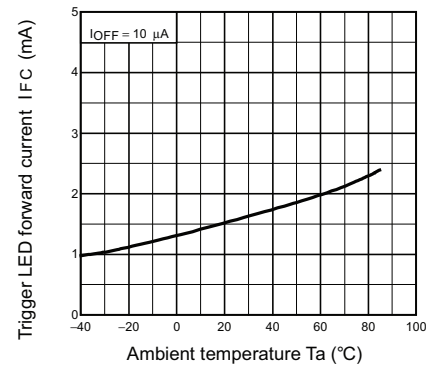

Turn ON, Turn OFF time vs. LED forward current  
tON, tOFF - IF

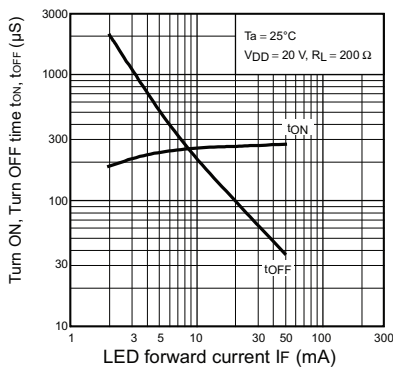

Turn ON, Turn OFF time vs. Ambient temperature  
tON, tOFF - Ta

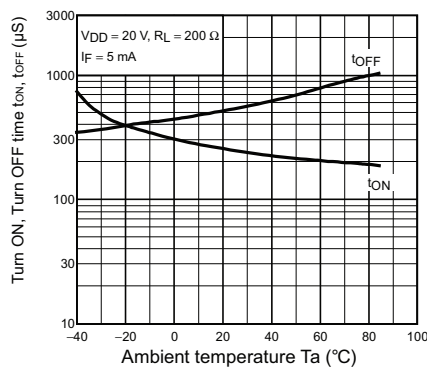

Current leakage vs. Ambient temperature  
ILEAK - Ta

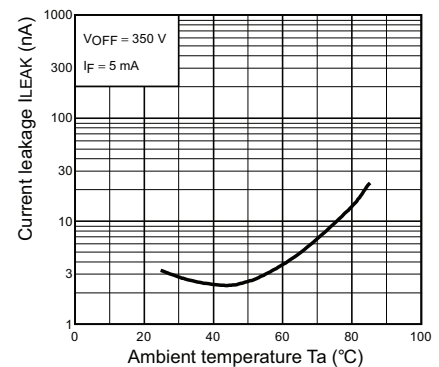



All sales are subject to Omron Electronic Components LLC standard terms and conditions of sale, which can be found at [http://www.components.omron.com/components/web/webfiles.nsf/sales\\_terms.html](http://www.components.omron.com/components/web/webfiles.nsf/sales_terms.html)

**ALL DIMENSIONS SHOWN ARE IN MILLIMETERS.**  
To convert millimeters into inches, multiply by 0.03937. To convert grams into ounces, multiply by 0.03527.

---

**OMRON**<sup>®</sup>

**OMRON ELECTRONIC  
COMPONENTS LLC**

55 E. Commerce Drive, Suite B  
Schaumburg, IL 60173

**847-882-2288**

**OMRON ON-LINE**

Global - <http://www.omron.com>

USA - <http://www.components.omron.com>

Cat. No. X302-E-1

12/10

Specifications subject to change without notice

Printed in USA