

## QUICK-START GUIDE

This guide outlines the installation and configuration process for the MP8000 Bluetooth® Overload Relays. For further technical information, refer to the product manual found at [Littelfuse.com/mp8000manual](http://Littelfuse.com/mp8000manual).

Ensure that the work area is de-energized prior to product installation. Follow your company's safety policy and lockout procedures.



Patent Pending

### INSTALLATION

1. Write down the pairing code and password located on the adhesive label on the side of the MP8000 and store in a secure location.
2. The MP8000 can be surface, DIN-rail or panel mounted in a sheltered enclosure environment that does not exceed the temperature and humidity ratings for the relay. (See Figure 9 for dimensions)
3. Provide control power to power the MP8000 with 85-264 VAC and connect to terminals A1 and A2 per the diagrams on page 2. (See Figures 10 and 11)

### CONFIGURATION

The MP8000 can be used via Bluetooth® using an Apple® or Android™ smartphone or tablet.

1. Pair Apple iPhone® or iPad® (iOS version 9.0 and higher) or Google Android™ (version 4.3 and higher) smartphone or tablet to MP8000:
  - a. Obtain pairing code from label on MP8000.
  - b. Download the free Littelfuse MP8000 app from Apple® App Store or Google Play™ Store.
  - c. Ensure Bluetooth® is turned on and the device is discoverable.
  - d. Select desired MP8000 from available devices in the Littelfuse app. (See Figure 1)
  - e. Enter pairing code for the MP8000. (See Figure 2)
  - f. Pairing is a one-time process per smartphone per MP8000.
  - g. If the MP8000 has never been configured, a popup box will appear prompting the user to configure the MP8000. (See Figure 3)
2. Entering settings on the MP8000:
  - a. Press the "Configuration" button.
  - b. Settings are divided into "Basic" for the most commonly used parameters and "Advanced" for less commonly used parameters.
  - c. Tap the desired parameter to enter the setting. (See Figure 4)
  - d. A popup box will appear. Enter the password for the unit. The password is located on product label. (See Figure 5)
 

**NOTE: A password is only required for modifying settings and is only required once per session. If the user disconnects from the MP8000, or the user moves out of range, the password will be required when re-connecting to the MP8000.**
  - e. A popup box will appear in which the numerical setting can be entered. Enter the setting and press "Save." (See Figure 6)
  - f. Continue through the other settings, entering values where desired.

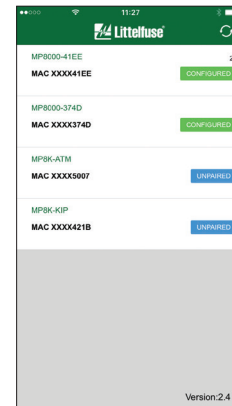

Figure 1

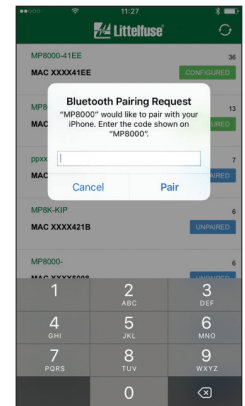

Figure 2

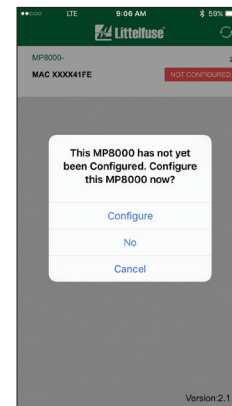

Figure 3

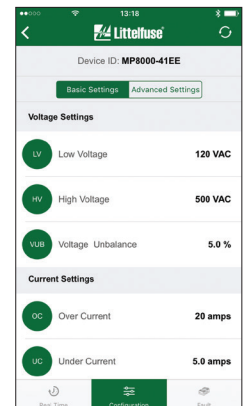

Figure 4

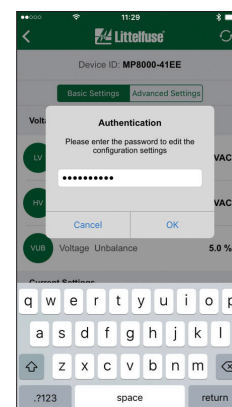

Figure 5

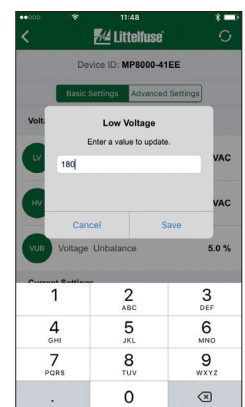

Figure 6

# MP8000 SERIES Bluetooth® Overload Relay

3. Viewing real-time information on the MP8000 (See Figure 7):
  - a. Press the “Real Time” button.
  - b. Scroll down to view the real-time measurements for each parameter.
4. Troubleshooting using the MP8000 (See Figure 8):
  - a. Press the “Fault” button at the bottom of the screen.
  - b. Fault information will appear on the screen in date order with the most recent fault appearing first.
  - c. The fault displays the parameter that had the fault, with a time and date stamp when the fault occurred.
  - d. Press the desired fault to display the conditions that were present at the time of the fault.
5. If the MP8000 needs to be reset, this can be accomplished via the app by pressing the reset button.

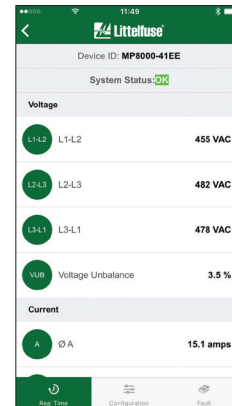

Figure 7

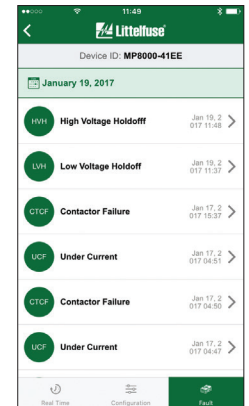

Figure 8

## Dimensions in inches (millimeters)

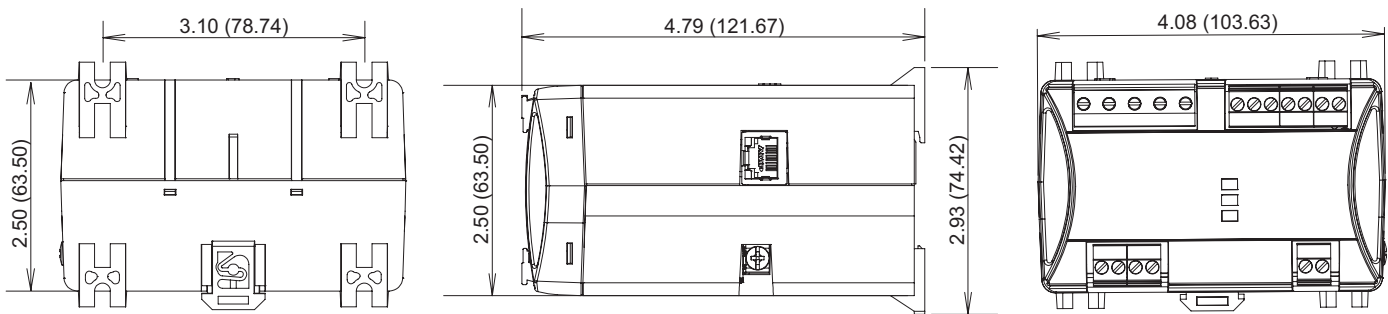

Figure 9

## 3-phase wiring diagram

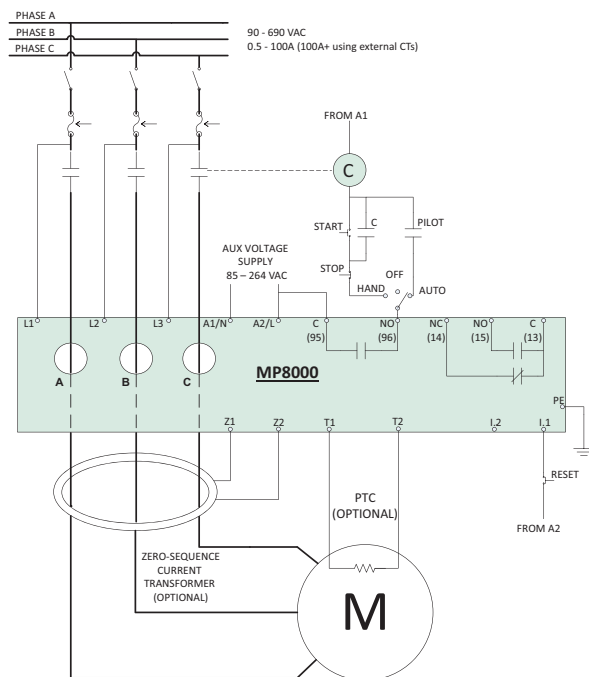

Figure 10

## Single-phase wiring diagram

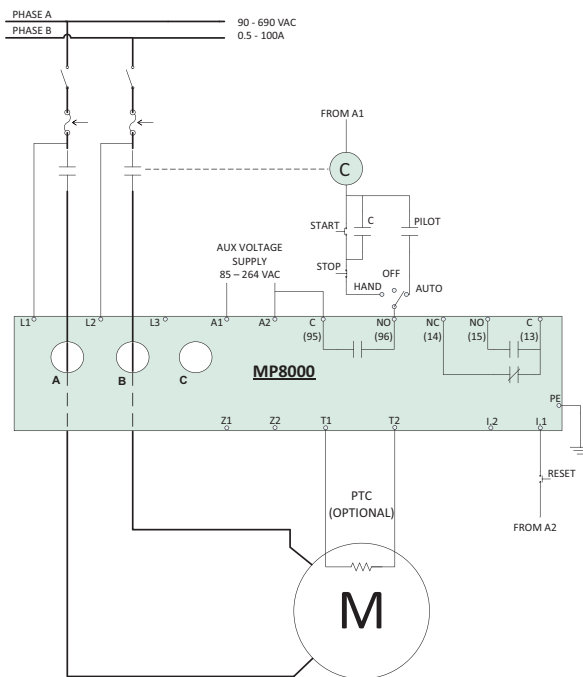

Figure 11

**Disclaimer Notice** – Information furnished is believed to be accurate and reliable. However, users should independently evaluate the suitability of and test each product selected for their own applications. Littelfuse products are not designed for, and may not be used in, all applications. Read complete Disclaimer Notice at [www.littelfuse.com/product-disclaimer](http://www.littelfuse.com/product-disclaimer).